

# Data Sheet | Item Number: 255-503/333-000

PCB terminal block; finger-operated levers; 2.5 mm<sup>2</sup>; Pin spacing 7.5/7.62 mm; 3-pole; CAGE CLAMP®; commoning option; 2,50 mm<sup>2</sup>; gray

<https://www.wago.com/255-503/333-000>



Color: ■ gray

Similar to illustration

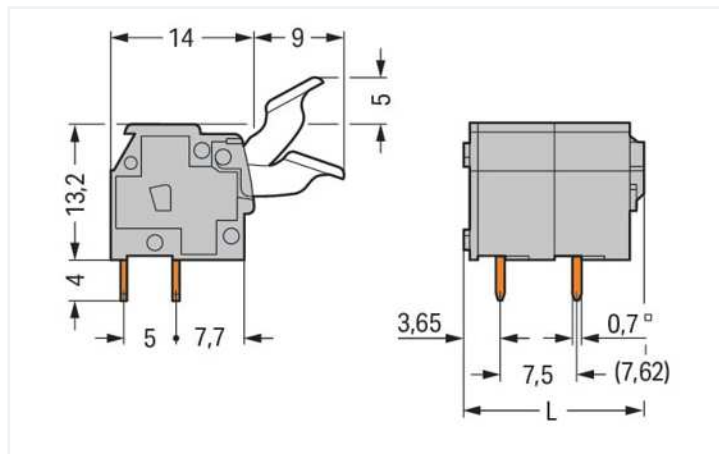

Dimensions in mm

L = (pole no. x pin spacing) + 2.9 mm

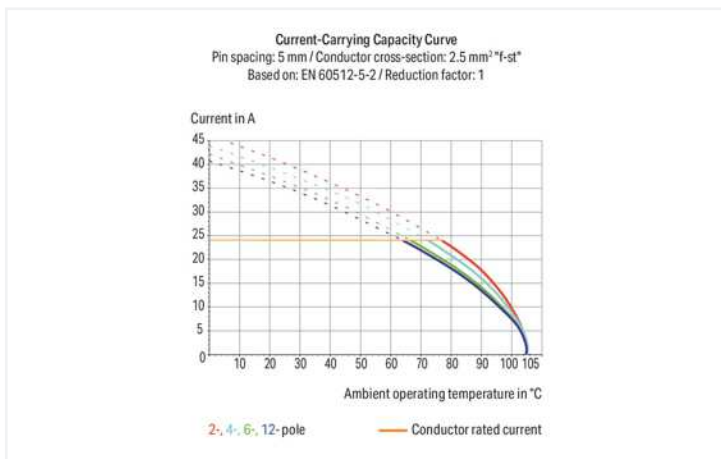

- PCB terminal blocks with push-buttons and CAGE CLAMP® connection
- Versions with Ex approval
- Set to metric or inch pin spacing by compressing PCB terminal strips or pulling them apart
- Ideal for in-the-field wiring thanks to simplified push-button actuation
- Convenient, tool-free operation

## Notes

Variants:

Other pole numbers  
 Versions for Ex e II and Ex i  
 Other colors  
 Mixed-color PCB connector strips  
 Direct marking  
 Other versions (or variants) can be requested from WAGO Sales or configured at <https://configurator.wago.com/>.

## Electrical data

### Ratings per IEC/EN

Ratings per	IEC/EN 60664-1
Nominal voltage (III/3)	500 V
Rated impulse voltage (III/3)	6 kV
Rated voltage (III/2)	630 V
Rated impulse voltage (III/2)	6 kV
Nominal voltage (II/2)	1000 V

### Ratings per IEC/EN

Rated surge voltage (II/2)	6 kV
Rated current	24 A
Legend (ratings)	(III / 2) ≙ Overvoltage category III / Pollution degree 2

### Ratings per UL 1059

Approvals per	UL 1059
Rated voltage UL (Use Group B)	300 V
Rated current UL (Use Group B)	15 A
Rated voltage UL (Use Group D)	300 V
Rated current UL (Use Group D)	10 A

### Ratings per CSA

Approvals per	CSA
Rated voltage CSA (Use Group B)	300 V
Rated current CSA (Use Group B)	15 A
Rated voltage CSA (Use Group D)	300 V
Rated current CSA (Use Group D)	10 A

### Connection data

Connection points	3
Total number of potentials	3
Number of connection types	1
Number of levels	1

### Connection 1

Connection technology	CAGE CLAMP®
Actuation type	Finger-operated lever
Solid conductor	0.08 ... 2.5 mm <sup>2</sup> / 25 ... 12 AWG
Fine-stranded conductor	0.08 ... 2.5 mm <sup>2</sup> / 28 ... 12 AWG
Fine-stranded conductor; with insulated ferrule	0.25 ... 1.5 mm <sup>2</sup>
Fine-stranded conductor; with uninsulated ferrule	0.25 ... 1.5 mm <sup>2</sup>
Note (conductor cross-section)	12 AWG: THHN, THWN
Strip length	5 ... 6 mm / 0.2 ... 0.24 inches
Conductor connection direction to PCB	90°
Pole number	3

### Physical data

Pin spacing	7.5/7.62 mm / 0.295/0.3 inches
Width	25.4 mm / 1 inches
Height	22.2 mm / 0.874 inches
Height from the surface	18.2 mm / 0.559 inches
Depth	23 mm / 0.906 inches
Solder pin length	4 mm
Solder pin dimensions	0.7 x 0.7 mm
Drilled hole diameter with tolerance	1.1 (+0.1) mm

### PCB contact

PCB contact	THT
Solder pin arrangement	over the entire terminal strip (in-line)
Number of solder pins per potential	2

### Material Data

Note (material data)	<a href="#">Information on material specifications can be found here</a>
Color	gray
Material group	I
Insulation material	Polyamide (PA66)
Flammability class per UL94	V0
Clamping spring material	Chrome-nickel spring steel (CrNi)
Contact material	Electrolytic copper (E <sub>Cu</sub> )
Contact plating	Tin
Fire load	0.123 MJ
Weight	4.6 g

## Environmental requirements

Limit temperature range	-60 ... +105 °C
-------------------------	-----------------

## Commercial data

Product Group	4 (Printed Circuit Connectors)
eCl@ss 10.0	27-44-04-01
eCl@ss 9.0	27-44-04-01
ETIM 8.0	EC002643
ETIM 7.0	EC002643
PU (SPU)	180 (45) pcs
Packaging type	Box
Country of origin	CH
GTIN	4044918661423
Customs tariff number	85369010000

## Approvals / Certificates

### General approvals



Approval	Standard	Certificate Name
UR Underwriters Laboratories Inc.	UL 1059	E45172

## Downloads

### Environmental Product Compliance

#### Compliance Search

Environmental Product  
Compliance  
255-503/333-000



## Documentation

### Additional Information

Technical Section	03.04.2019	pdf 1949.09 KB	
Gebrückte Klemmen- leisten für Leiterplatten		pdf 303.71 KB	

## CAD/CAE-Data

**CAD data**

2D/3D Models  
255-503/333-000 

**CAE data**

































ZUKEN Portal  
255-503/333-000 

**1 Compatible Products**

**1.1 Optional Accessories**

**1.1.1 Ferrule**

**1.1.1.1 Ferrule**

 <p><b>Item No.: 216-301</b> Ferrule; Sleeve for 0.25 mm<sup>2</sup> / AWG 24; insulated; electro-tin plated; yellow</p>	 <p><b>Item No.: 216-321</b> Ferrule; Sleeve for 0.25 mm<sup>2</sup> / AWG 24; insulated; electro-tin plated; yellow</p>	 <p><b>Item No.: 216-151</b> Ferrule; Sleeve for 0.25 mm<sup>2</sup> / AWG 24; uninsulated; electro-tin plated</p>	 <p><b>Item No.: 216-131</b> Ferrule; Sleeve for 0.25 mm<sup>2</sup> / AWG 24; uninsulated; electro-tin plated; silver-colored</p>
 <p><b>Item No.: 216-302</b> Ferrule; Sleeve for 0.34 mm<sup>2</sup> / 22 AWG; insulated; electro-tin plated; light turquoise</p>	 <p><b>Item No.: 216-322</b> Ferrule; Sleeve for 0.34 mm<sup>2</sup> / 22 AWG; insulated; electro-tin plated; light turquoise</p>	 <p><b>Item No.: 216-132</b> Ferrule; Sleeve for 0.34 mm<sup>2</sup> / AWG 24; uninsulated; electro-tin plated</p>	 <p><b>Item No.: 216-152</b> Ferrule; Sleeve for 0.34 mm<sup>2</sup> / AWG 24; uninsulated; electro-tin plated</p>
 <p><b>Item No.: 216-241</b> Ferrule; Sleeve for 0.5 mm<sup>2</sup> / 20 AWG; insulated; electro-tin plated; electrolytic copper; gastight crimped; acc. to DIN 46228, Part 4/09.90; white</p>	 <p><b>Item No.: 216-201</b> Ferrule; Sleeve for 0.5 mm<sup>2</sup> / 20 AWG; insulated; electro-tin plated; white</p>	 <p><b>Item No.: 216-221</b> Ferrule; Sleeve for 0.5 mm<sup>2</sup> / 20 AWG; insulated; electro-tin plated; white</p>	 <p><b>Item No.: 216-141</b> Ferrule; Sleeve for 0.5 mm<sup>2</sup> / 20 AWG; insulated; electro-tin plated; electrolytic copper; gastight crimped; acc. to DIN 46228, Part 1/08.92</p>
 <p><b>Item No.: 216-101</b> Ferrule; Sleeve for 0.5 mm<sup>2</sup> / AWG 22; un-insulated; electro-tin plated; silver-colored</p>	 <p><b>Item No.: 216-121</b> Ferrule; Sleeve for 0.5 mm<sup>2</sup> / AWG 22; un-insulated; electro-tin plated; silver-colored</p>	 <p><b>Item No.: 216-242</b> Ferrule; Sleeve for 0.75 mm<sup>2</sup> / 18 AWG; insulated; electro-tin plated; electrolytic copper; gastight crimped; acc. to DIN 46228, Part 4/09.90; gray</p>	 <p><b>Item No.: 216-262</b> Ferrule; Sleeve for 0.75 mm<sup>2</sup> / 18 AWG; insulated; electro-tin plated; electrolytic copper; gastight crimped; acc. to DIN 46228, Part 4/09.90; gray</p>
 <p><b>Item No.: 216-202</b> Ferrule; Sleeve for 0.75 mm<sup>2</sup> / 18 AWG; insulated; electro-tin plated; gray</p>	 <p><b>Item No.: 216-222</b> Ferrule; Sleeve for 0.75 mm<sup>2</sup> / 18 AWG; insulated; electro-tin plated; gray</p>	 <p><b>Item No.: 216-142</b> Ferrule; Sleeve for 0.75 mm<sup>2</sup> / 18 AWG; un-insulated; electro-tin plated; electrolytic copper; gastight crimped; acc. to DIN 46228, Part 1/08.92</p>	 <p><b>Item No.: 216-102</b> Ferrule; Sleeve for 0.75 mm<sup>2</sup> / AWG 20; un-insulated; electro-tin plated; silver-colored</p>
 <p><b>Item No.: 216-122</b> Ferrule; Sleeve for 0.75 mm<sup>2</sup> / AWG 20; un-insulated; electro-tin plated; silver-colored</p>	 <p><b>Item No.: 216-243</b> Ferrule; Sleeve for 1 mm<sup>2</sup> / AWG 18; insulated; electro-tin plated; electrolytic copper; gastight crimped; acc. to DIN 46228, Part 4/09.90; red</p>	 <p><b>Item No.: 216-263</b> Ferrule; Sleeve for 1 mm<sup>2</sup> / AWG 18; insulated; electro-tin plated; electrolytic copper; gastight crimped; acc. to DIN 46228, Part 4/09.90; red</p>	 <p><b>Item No.: 216-203</b> Ferrule; Sleeve for 1 mm<sup>2</sup> / AWG 18; insulated; electro-tin plated; red</p>
 <p><b>Item No.: 216-223</b> Ferrule; Sleeve for 1 mm<sup>2</sup> / AWG 18; insulated; electro-tin plated; red</p>	 <p><b>Item No.: 216-103</b> Ferrule; Sleeve for 1 mm<sup>2</sup> / AWG 18; un-insulated; electro-tin plated</p>	 <p><b>Item No.: 216-143</b> Ferrule; Sleeve for 1 mm<sup>2</sup> / AWG 18; un-insulated; electro-tin plated; electrolytic copper; gastight crimped; acc. to DIN 46228, Part 1/08.92</p>	 <p><b>Item No.: 216-123</b> Ferrule; Sleeve for 1 mm<sup>2</sup> / AWG 18; un-insulated; electro-tin plated; silver-colored</p>
 <p><b>Item No.: 216-204</b> Ferrule; Sleeve for 1.5 mm<sup>2</sup> / AWG 16; insulated; electro-tin plated; black</p>	 <p><b>Item No.: 216-224</b> Ferrule; Sleeve for 1.5 mm<sup>2</sup> / AWG 16; insulated; electro-tin plated; black</p>	 <p><b>Item No.: 216-244</b> Ferrule; Sleeve for 1.5 mm<sup>2</sup> / AWG 16; insulated; electro-tin plated; electrolytic copper; gastight crimped; acc. to DIN 46228, Part 4/09.90; black</p>	 <p><b>Item No.: 216-264</b> Ferrule; Sleeve for 1.5 mm<sup>2</sup> / AWG 16; insulated; electro-tin plated; electrolytic copper; gastight crimped; acc. to DIN 46228, Part 4/09.90; black</p>

1.1.1.1 Ferrule



**Item No.: 216-284**

Ferrule; Sleeve for 1.5 mm<sup>2</sup> / AWG 16; insulated; electro-tin plated; electrolytic copper; gastight crimped; acc. to DIN 46228, Part 4/09.90; black

**Item No.: 216-124**

Ferrule; Sleeve for 1.5 mm<sup>2</sup> / AWG 16; un-insulated; electro-tin plated

**Item No.: 216-144**

Ferrule; Sleeve for 1.5 mm<sup>2</sup> / AWG 16; un-insulated; electro-tin plated; electrolytic copper; gastight crimped; acc. to DIN 46228, Part 1/08.92; silver-colored

**Item No.: 216-104**

Ferrule; Sleeve for 1.5 mm<sup>2</sup> / AWG 16; un-insulated; electro-tin plated; silver-colored

1.1.2 Marking

1.1.2.1 Marking strip



**Item No.: 210-833**

Marking strips; 25 m on roll; 6 mm wide; plain; Self-adhesive; white

**Item No.: 210-332/750-020**

Marking strips; as a DIN A4 sheet; MARKED; 1-20 (80x); Height of marker strip: 3 mm; Strip length 182 mm; Horizontal marking; Self-adhesive; white

**Item No.: 210-332/762-020**

Marking strips; as a DIN A4 sheet; MARKED; 1-20 (80x); Height of marker strip: 3 mm; Strip length 182 mm; Horizontal marking; Self-adhesive; white

1.1.3 Test and measurement

1.1.3.1 Testing accessories



**Item No.: 249-112**

Test plug adapter; suitable for 255, 256, 257 Series PCB terminal blocks; 1-pole; Pin spacing 7.5 mm / 0.295 in; gray

**Item No.: 249-113**

Test plug adapter; suitable for 255, 256, 257 Series PCB terminal blocks; 1-pole; Pin spacing 7.62 mm / 0.3 in; orange

Installation Notes

Conductor termination



Inserting/removing a conductor – 256 Series.



Inserting/removing a conductor (255 Series)



Inserting/removing a conductor via finger-operated lever – 255 Series.



Inserting/removing a conductor via finger-operated lever – 256 Series.

## Installation



Possible conductor arrangement with terminal strips staggered (for 256 Series only).

## Marking



Formation of groups using housings of different colors

## Testing



Testing with test probes.



Testing with test plug modules.