

Data Sheet | Item Number: 255-403

PCB terminal block; push-button; 2.5 mm²; Pin spacing 5/5.08 mm; 3-pole; CAGE CLAMP®; commoning option; 2,50 mm²; gray

<https://www.wago.com/255-403>

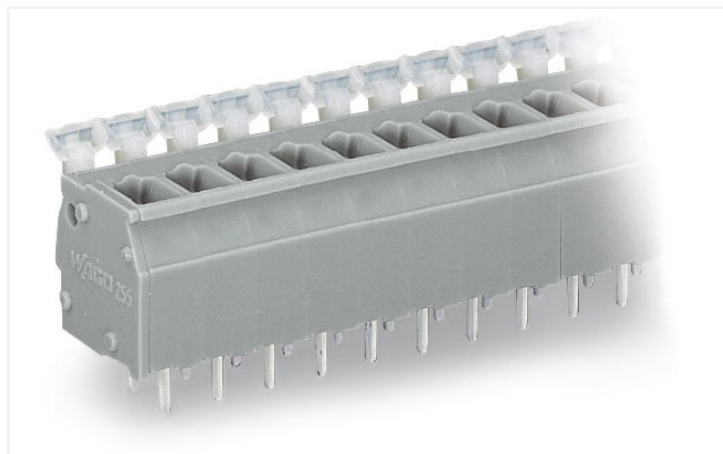

Color: ■ gray

Similar to illustration

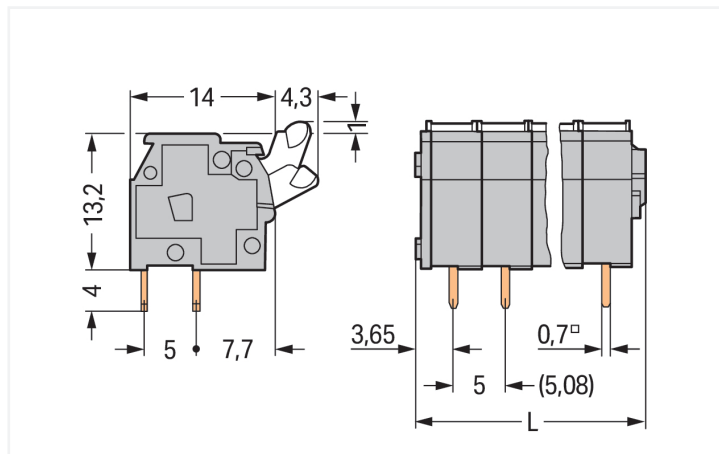

Dimensions in mm

L = (pole no. x pin spacing) + 2.9 mm

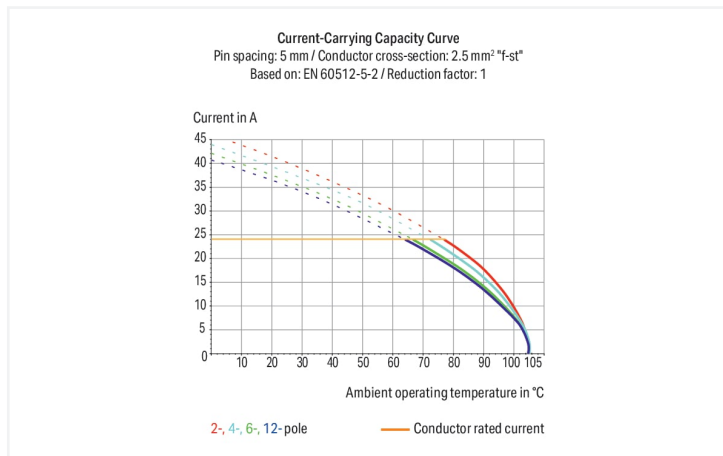

- PCB terminal blocks with push-buttons and CAGE CLAMP® connection
- Versions with Ex approval
- Set to metric or inch pin spacing by compressing PCB terminal strips or pulling them apart
- Ideal for in-the-field wiring thanks to simplified push-button actuation
- Convenient, tool-free operation

Notes

Variants:

Mixed-color PCB connector strips
Direct marking
Other versions (or variants) can be requested from WAGO Sales or configured at <https://configurator.wago.com/>.
Other pole numbers
Versions for Ex e II and Ex i
Other colors

Electrical data

Ratings per	IEC/EN 60664-1			Approvals per	UL 1059		
	III	III	II		B	C	D
Overtoltage category	III	III	II	Use group	B	C	D
Pollution degree	3	2	2	Rated voltage	300 V	-	300 V
Nominal voltage	320 V	320 V	630 V	Rated current	15 A	-	10 A
Rated surge voltage	4 kV	4 kV	4 kV				
Rated current	24 A	24 A	24 A				

Approvals per	CSA		
	B	C	D
Use group	B	C	D
Rated voltage	300 V	-	300 V
Rated current	15 A	-	10 A

Connection data

Clamping units	3
Total number of potentials	3
Number of connection types	1
Number of levels	1

Connection 1

Connection technology	CAGE CLAMP®
Actuation type	Push-button
Solid conductor	0.08 ... 2.5 mm ² / 28 ... 12 AWG
Fine-stranded conductor	0.08 ... 2.5 mm ² / 28 ... 12 AWG
Fine-stranded conductor; with insulated ferrule	0.25 ... 1.5 mm ²
Fine-stranded conductor; with uninsulated ferrule	0.25 ... 1.5 mm ²
Note (conductor cross-section)	12 AWG: THHN, THWN
Strip length	5 ... 6 mm / 0.2 ... 0.24 inches
Conductor connection direction to PCB	90°
Pole number	3

Physical data

Pin spacing	5/5.08 mm / 0.197/0.2 inches
Width	17.9 mm / 0.705 inches
Height	18.2 mm / 0.717 inches
Height from the surface	14.2 mm / 0.559 inches
Depth	18.3 mm / 0.72 inches
Solder pin length	4 mm
Solder pin dimensions	0.7 x 0.7 mm
Drilled hole diameter with tolerance	1.1 (+0.1) mm

PCB contact

PCB contact	THT
Solder pin arrangement	over the entire terminal strip (in-line)
Number of solder pins per potential	2

Material data

Note (material data)	Information on material specifications can be found here
Color	gray
Material group	I
Insulation material (main housing)	Polyamide (PA66)
Flammability class per UL94	V0
Clamping spring material	Chrome-nickel spring steel (CrNi)
Contact material	Electrolytic copper (E _{Cu})
Contact Plating	Tin
Fire load	0.072 MJ
Weight	3.7 g

Environmental requirements

Limit temperature range	-60 ... +105 °C
-------------------------	-----------------

Commercial data

Product Group	4 (Printed Circuit Connectors)
eCl@ss 10.0	27-44-04-01
eCl@ss 9.0	27-44-04-01
ETIM 9.0	EC002643
ETIM 8.0	EC002643
PU (SPU)	280 (70) pcs
Packaging type	Box
Country of origin	CH
GTIN	4044918658904
Customs tariff number	85369010000

Environmental Product Compliance

RoHS Compliance Status	Compliant, No Exemption
------------------------	-------------------------

Approvals / Certificates

General approvals



Approval	Standard	Certificate Name
CCA DEKRA Certification B.V.	EN 60947	2160584.40
CCA DEKRA Certification B.V.	EN 60947	NTR NL-7146
CCA DEKRA Certification B.V.	EN 60947-7-4	71-113038
CCA DEKRA Certification B.V.	IEC 60947-7-4	NTR NL-7822
UR Underwriters Laboratories Inc.	UL 1059	E45172

Declarations of conformity and manufacturer's declarations

Approval	Standard	Certificate Name
EU-Declaration of Confor- mity WAGO GmbH & Co. KG	-	-
UK-Declaration of Confor- mity WAGO GmbH & Co. KG	-	-

Approvals for marine applications



Approval	Standard	Certificate Name
ABS American Bureau of Ship- ping	-	19-HG1869876-PDA
BV Bureau Veritas S.A.	IEC 60998	11915/D0 BV
DNV DNV GL SE	-	TAE000016Z

Downloads

Environmental Product Compliance

Compliance Search	
Environmental Product Compliance 255-403	↓

Documentation

Additional Information			
Technical Section	03.04.2019	pdf 2027.26 KB	↓
Gebrückte Klemmen- leisten für Leiterplatten		pdf 303.71 KB	↓

CAD/CAE-Data

CAD data	
2D/3D Models 255-403	↓

CAE data	
EPLAN Data Portal 255-403	↓
ZUKEN Portal 255-403	↓

PCB Design	
Symbol and Footprint via SamacSys 255-403	↓
Symbol and Footprint via Ultra Librarian 255-403	↓

1 Compatible Products



















1.1 Optional Accessories

1.1.1 Ferrule

1.1.1.1 Ferrule









<p>Item No.: 216-301 Ferrule; Sleeve for 0.25 mm² / AWG 24; insulated; electro-tin plated; yellow</p>	<p>Item No.: 216-321 Ferrule; Sleeve for 0.25 mm² / AWG 24; insulated; electro-tin plated; yellow</p>	<p>Item No.: 216-151 Ferrule; Sleeve for 0.25 mm² / AWG 24; uninsulated; electro-tin plated</p>	<p>Item No.: 216-131 Ferrule; Sleeve for 0.25 mm² / AWG 24; uninsulated; electro-tin plated; silver-colored</p>
<p>Item No.: 216-302 Ferrule; Sleeve for 0.34 mm² / 22 AWG; insulated; electro-tin plated; light turquoise</p>	<p>Item No.: 216-322 Ferrule; Sleeve for 0.34 mm² / 22 AWG; insulated; electro-tin plated; light turquoise</p>	<p>Item No.: 216-132 Ferrule; Sleeve for 0.34 mm² / AWG 24; uninsulated; electro-tin plated</p>	<p>Item No.: 216-152 Ferrule; Sleeve for 0.34 mm² / AWG 24; uninsulated; electro-tin plated</p>
<p>Item No.: 216-241 Ferrule; Sleeve for 0.5 mm² / 20 AWG; insulated; electro-tin plated; electrolytic copper; gastight crimped; acc. to DIN 46228, Part 4/09.90; white</p>	<p>Item No.: 216-201 Ferrule; Sleeve for 0.5 mm² / 20 AWG; insulated; electro-tin plated; white</p>	<p>Item No.: 216-221 Ferrule; Sleeve for 0.5 mm² / 20 AWG; insulated; electro-tin plated; white</p>	<p>Item No.: 216-141 Ferrule; Sleeve for 0.5 mm² / 20 AWG; uninsulated; electro-tin plated; electrolytic copper; gastight crimped; acc. to DIN 46228, Part 1/08.92</p>

1.1.1.1 Ferrule

 <p>Item No.: 216-101 Ferrule; Sleeve for 0.5 mm² / AWG 22; un-insulated; electro-tin plated; silver-colored</p>	 <p>Item No.: 216-121 Ferrule; Sleeve for 0.5 mm² / AWG 22; un-insulated; electro-tin plated; silver-colored</p>	 <p>Item No.: 216-242 Ferrule; Sleeve for 0.75 mm² / 18 AWG; insulated; electro-tin plated; electrolytic copper; gastight crimped; acc. to DIN 46228, Part 4/09.90; gray</p>	 <p>Item No.: 216-262 Ferrule; Sleeve for 0.75 mm² / 18 AWG; insulated; electro-tin plated; electrolytic copper; gastight crimped; acc. to DIN 46228, Part 4/09.90; gray</p>
 <p>Item No.: 216-202 Ferrule; Sleeve for 0.75 mm² / 18 AWG; insulated; electro-tin plated; gray</p>	 <p>Item No.: 216-222 Ferrule; Sleeve for 0.75 mm² / 18 AWG; insulated; electro-tin plated; gray</p>	 <p>Item No.: 216-142 Ferrule; Sleeve for 0.75 mm² / 18 AWG; un-insulated; electro-tin plated; electrolytic copper; gastight crimped; acc. to DIN 46228, Part 1/08.92</p>	 <p>Item No.: 216-102 Ferrule; Sleeve for 0.75 mm² / AWG 20; un-insulated; electro-tin plated; silver-colored</p>
 <p>Item No.: 216-122 Ferrule; Sleeve for 0.75 mm² / AWG 20; un-insulated; electro-tin plated; silver-colored</p>	 <p>Item No.: 216-243 Ferrule; Sleeve for 1 mm² / AWG 18; insulated; electro-tin plated; electrolytic copper; gastight crimped; acc. to DIN 46228, Part 4/09.90; red</p>	 <p>Item No.: 216-263 Ferrule; Sleeve for 1 mm² / AWG 18; insulated; electro-tin plated; electrolytic copper; gastight crimped; acc. to DIN 46228, Part 4/09.90; red</p>	 <p>Item No.: 216-203 Ferrule; Sleeve for 1 mm² / AWG 18; insulated; electro-tin plated; red</p>
 <p>Item No.: 216-223 Ferrule; Sleeve for 1 mm² / AWG 18; un-insulated; electro-tin plated; red</p>	 <p>Item No.: 216-103 Ferrule; Sleeve for 1 mm² / AWG 18; un-insulated; electro-tin plated</p>	 <p>Item No.: 216-143 Ferrule; Sleeve for 1 mm² / AWG 18; un-insulated; electro-tin plated; electrolytic copper; gastight crimped; acc. to DIN 46228, Part 1/08.92</p>	 <p>Item No.: 216-123 Ferrule; Sleeve for 1 mm² / AWG 18; un-insulated; electro-tin plated; silver-colored</p>
 <p>Item No.: 216-204 Ferrule; Sleeve for 1.5 mm² / AWG 16; insulated; electro-tin plated; black</p>	 <p>Item No.: 216-224 Ferrule; Sleeve for 1.5 mm² / AWG 16; insulated; electro-tin plated; black</p>	 <p>Item No.: 216-244 Ferrule; Sleeve for 1.5 mm² / AWG 16; insulated; electro-tin plated; electrolytic copper; gastight crimped; acc. to DIN 46228, Part 4/09.90; black</p>	 <p>Item No.: 216-264 Ferrule; Sleeve for 1.5 mm² / AWG 16; insulated; electro-tin plated; electrolytic copper; gastight crimped; acc. to DIN 46228, Part 4/09.90; black</p>
 <p>Item No.: 216-284 Ferrule; Sleeve for 1.5 mm² / AWG 16; insulated; electro-tin plated; electrolytic copper; gastight crimped; acc. to DIN 46228, Part 4/09.90; black</p>	 <p>Item No.: 216-124 Ferrule; Sleeve for 1.5 mm² / AWG 16; un-insulated; electro-tin plated</p>	 <p>Item No.: 216-144 Ferrule; Sleeve for 1.5 mm² / AWG 16; un-insulated; electro-tin plated; electrolytic copper; gastight crimped; acc. to DIN 46228, Part 1/08.92; silver-colored</p>	 <p>Item No.: 216-104 Ferrule; Sleeve for 1.5 mm² / AWG 16; un-insulated; electro-tin plated; silver-colored</p>

1.1.2 Marking

1.1.2.1 Marking strip

 <p>Item No.: 210-833 Marking strips; 25 m on roll; 6 mm wide; plain; Self-adhesive; white</p>	 <p>Item No.: 210-332/500-202 Marking strips; as a DIN A4 sheet; MARKED; 1-16 (160x); Height of marker strip: 3 mm; Strip length 182 mm; Horizontal marking; Self-adhesive; white</p>	 <p>Item No.: 210-332/508-202 Marking strips; as a DIN A4 sheet; MARKED; 1-16 (160x); Height of marker strip: 3 mm; Strip length 182 mm; Horizontal marking; Self-adhesive; white</p>	 <p>Item No.: 210-332/500-205 Marking strips; as a DIN A4 sheet; MARKED; 1-32 (80x); Height of marker strip: 3 mm; Strip length 182 mm; Horizontal marking; Self-adhesive; white</p>
 <p>Item No.: 210-332/508-205 Marking strips; as a DIN A4 sheet; MARKED; 1-32 (80x); Height of marker strip: 3 mm; Strip length 182 mm; Horizontal marking; Self-adhesive; white</p>	 <p>Item No.: 210-332/500-204 Marking strips; as a DIN A4 sheet; MARKED; 17-32 (160x); Height of marker strip: 3 mm; Strip length 182 mm; Horizontal marking; Self-adhesive; white</p>	 <p>Item No.: 210-332/508-204 Marking strips; as a DIN A4 sheet; MARKED; 17-32 (160x); Height of marker strip: 3 mm; Strip length 182 mm; Horizontal marking; Self-adhesive; white</p>	 <p>Item No.: 210-332/500-206 Marking strips; as a DIN A4 sheet; MARKED; 33-48 (160x); Height of marker strip: 3 mm; Strip length 182 mm; Horizontal marking; Self-adhesive; white</p>
 <p>Item No.: 210-332/508-206 Marking strips; as a DIN A4 sheet; MARKED; 33-48 (160x); Height of marker strip: 3 mm; Strip length 182 mm; Horizontal marking; Self-adhesive; white</p>			

1.1.3 Test and measurement

1.1.3.1 Testing accessories



Item No.: 249-110

Test plug adapter; suitable for 255, 256, 257 Series PCB terminal blocks; 1-pole; Pin spacing 5 mm / 0.197 in; gray

Item No.: 249-111

Test plug adapter; suitable for 255, 256, 257 Series PCB terminal blocks; 1-pole; Pin spacing 5.08 mm / 0.2 in; orange

1.1.4 Tool

1.1.4.1 Operating tool



Item No.: 210-658

Operating tool; Blade: 3.5 x 0.5 mm; with a partially insulated shaft; angled; short; multicoloured

Item No.: 210-720

Operating tool; Blade: 3.5 x 0.5 mm; with a partially insulated shaft; multicoloured

Installation Notes

Conductor termination

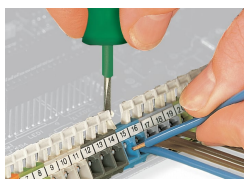

Inserting/removing a conductor – 256 Series.

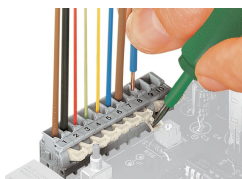

Inserting/removing a conductor (255 Series)

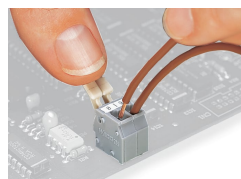

Inserting/removing a conductor via finger-operated lever – 255 Series.

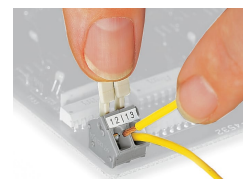

Inserting/removing a conductor via finger-operated lever – 256 Series.

Installation

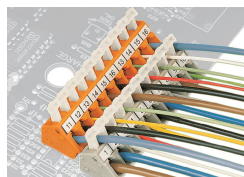

Possible conductor arrangement with terminal strips staggered (for 256 Series only).

Marking

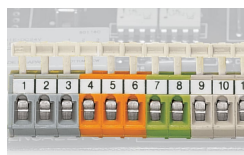

Formation of groups using housings of different colors

Testing

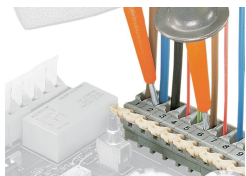

Testing with test probes.



Testing with test plug modules.