

**OMNIMATE Signal - series BL/SL 2.50
SL 2.50/12/180G 3.2SN BK BX**

Weidmüller Interface GmbH & Co. KG
Klingenbergstraße 16
D-32758 Detmold
Germany
Fon: +49 5231 14-0
Fax: +49 5231 14-292083
www.weidmueller.com

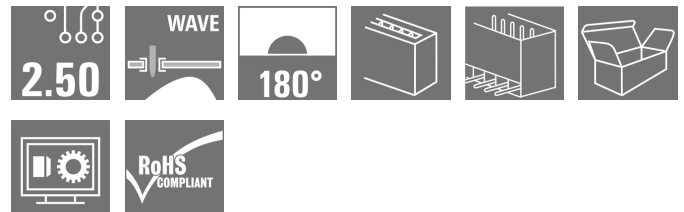

Male header for wave soldering in 2.50 mm pitch.

- Plugging direction is straight (180°) to the PCB
- Housing variant: Closed (G)
- Packaged in a cardboard box (BX)

General ordering data

Type	SL 2.50/12/180G 3.2SN BK BX
Order No.	2440010000
Version	PCB plug-in connector, male header, THT solder connection, Pitch in mm (P): 2.50 mm, No. of poles: 12, 180°, Box
GTIN (EAN)	4050118455182
Qty.	75 pc(s).
Product data	IEC: 320 V / 6 A UL: 150 V / 5 A
Packaging	Box

**OMNIMATE Signal - series BL/SL 2.50
SL 2.50/12/180G 3.2SN BK BX**

Weidmüller Interface GmbH & Co. KG
Klingenbergstraße 16
D-32758 Detmold
Germany
Fon: +49 5231 14-0
Fax: +49 5231 14-292083
www.weidmueller.com

Technical data
Dimensions and weights

Net weight 3.44 g

System specifications

Product family	OMNIMATE Signal - series BL/SL 2.50	Type of connection	Solder connection
Mounting onto the PCB	THT solder connection	Pitch in mm (P)	2.5 mm
Pitch in inches (P)	0.984 inch	Outgoing elbow	180°
No. of poles	12	Number of solder pins per pole	1
Solder pin length (l)	3.2 mm	Solder pin length tolerance	+0.1 / -0.1 mm
Tolerance of solder pin position	± 0.15 mm	Solder pin dimensions	0.8 x 0.8 mm
Solder pin dimensions = d tolerance	+0,02 / -0,02 mm	Solder eyelet hole diameter (D)	1.3 mm
Solder eyelet hole diameter tolerance (D)	+ 0,1 mm	L1 in mm	27.5 mm
L1 in inches	10.824 inch	Number of rows	1
Pin series quantity	1	Touch-safe protection acc. to DIN VDE 57 106	Finger-safe plugged/ back-of-hand-safe unplugged
Touch-safe protection acc. to DIN VDE 0470	IP 00	Plugging cycles	25
Packaging	Box		

Material data

Insulating material	PA 66	Colour	Black
Colour chart (similar)	RAL 9011	CTI	≥ 600
UL 94 flammability rating	V-0	Contact material	Copper alloy
Contact surface	tinned	Tinning type	matt
Layer structure of solder connection	1-3 µm Ni / 4-6 µm Sn matt	Operating temperature, min.	-40 °C
Operating temperature, max.	105 °C		

Rated data acc. to IEC

tested acc. to standard	IEC 61984	Rated current, min. no. of poles (Tu=20°C)	6 A
Rated current, min. no. of poles (Tu=40°C)	6 A	Rated voltage for surge voltage class / pollution degree II/2	320 V
Rated voltage for surge voltage class / pollution degree III/2	320 V	Rated voltage for surge voltage class / pollution degree III/3	80 V
Rated impulse voltage for surge voltage class/ pollution degree II/2	2.5 kV	Rated impulse voltage for surge voltage class/ pollution degree III/2	2.5 kV
Rated impulse voltage for surge voltage class/ contamination degree III/3	2.5 kV		

Rated data acc. to CSA

Rated voltage (Use group B)	150 V	Rated current (use group B)	5 A
-----------------------------	-------	-----------------------------	-----

**OMNIMATE Signal - series BL/SL 2.50
SL 2.50/12/180G 3.2SN BK BX**

Weidmüller Interface GmbH & Co. KG
 Klingenbergstraße 16
 D-32758 Detmold
 Germany
 Fon: +49 5231 14-0
 Fax: +49 5231 14-292083
 www.weidmueller.com

Technical data**Rated data acc. to UL 1059**

Institute (cURus)		Certificate No. (cURus)	E60693
Rated voltage (use group B)	150 V	Rated current (use group B)	5 A
Reference to approval values	Specifications are maximum values, details - see approval certificate.		

Classifications

ETIM 6.0	EC002637	eClass 6.2	27-26-07-04
eClass 9.1	27-44-04-02		

Notes

Notes	<ul style="list-style-type: none"> Rated current related to rated cross-section & min. No. of poles. P on drawing = pitch Rated data refer only to the component itself. Clearance and creepage distances to other components are to be designed in accordance with the relevant application standards.
IPC conformity	The products are developed, manufactured and delivered according to the internationally recognised IPC-A-610 standard, category "permissible". More extensive demands on the products can be evaluated on request.

Approvals

Approvals	
-----------	---

Downloads

Approval/Certificate/Document of Conformity	Declaration of the Manufacturer
Brochure/Catalogue	FL DRIVES EN MB DEVICE MANUF. EN FL DRIVES DE FL BUILDING SAFETY EN FL APPL LED LIGHTING EN FL INDUSTR.CONTROLS EN FL MACHINE SAFETY EN FL HEATING ELECTR EN FL APPL INVERTER EN FL_BASE_STATION_EN FL ELEVATOR EN FL POWER SUPPLY EN FL 72H SAMPLE SER EN PO OMNIMATE EN
Engineering Data	EPLAN, WSCAD

**OMNIMATE Signal - series BL/SL 2.50
SL 2.50/12/180G 3.2SN BK BX**

Weidmüller Interface GmbH & Co. KG
Klingenbergstraße 16
D-32758 Detmold
Germany
Fon: +49 5231 14-0
Fax: +49 5231 14-292083
www.weidmueller.com

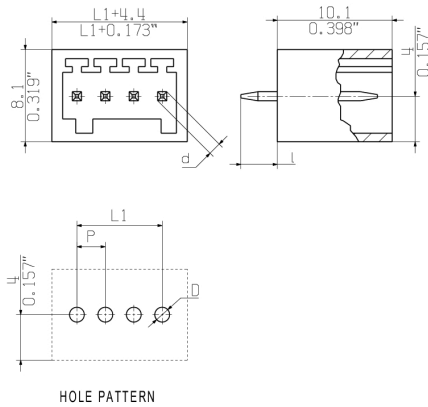
Drawings**Dimensional drawing**

Recommended wave soldering profiles

Weidmüller Interface GmbH & Co. KG
 Klängenbergstraße 16
 D-32758 Detmold
 Germany
 Fon: +49 5231 14-0
 Fax: +49 5231 14-292083
 www.weidmueller.com

Single Wave:



Double Wave:



Wave soldering profiles

Wired connection elements should be processed in accordance with the DIN EN 61760-1 standard. We have included two recommendations for practical wave soldering profiles, with which Weidmüller PCB terminals and connectors are qualified.

When choosing a suitable profile for your application, the following factors also need to be considered:

- PCB thickness
- Proportion of Cu in the layers
- Single/double-sided assembly
- Product range
- Heating and cooling rates

The single and double wave profiles each indicate the recommended operating range, including the maximum soldering temperature of 260°C. In practice, the maximum soldering temperature is quite often well below the above maximum profile.