

SL 2.50/08/180G 3.2SN BK BX
Weidmüller Interfaces GmbH & Co. KG

Postfach 3030

32760 Detmold

Tel. +49 5231 14-0

Fax. +49 5231 14-2083

info@weidmueller.com

www.weidmueller.com

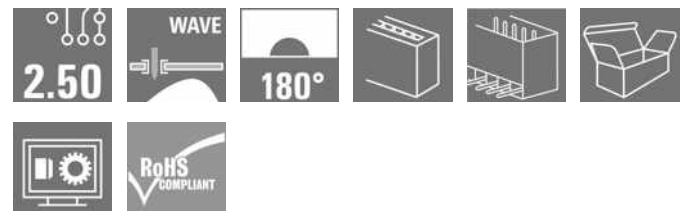
Product image

Male header for wave soldering in 2.50 mm pitch.

- Plugging direction is straight (180°) to the PCB
- Housing variant: Closed (G)
- Packaged in a cardboard box (BX)

General ordering data

Version	PCB plug-in connector, male header, THT solder connection, Pitch in mm (P): 2.50 mm, Number of poles: 8, 180°, Box
Order No.	2439970000
Type	SL 2.50/08/180G 3.2SN BK BX
GTIN (EAN)	4050118455144
Qty.	125 pc(s).
Product data	IEC: 320 V / 6 A UL: 150 V / 5 A
Packaging	Box

SL 2.50/08/180G 3.2SN BK BX
Weidmüller Interfaces GmbH & Co. KG

Postfach 3030

32760 Detmold

Tel. +49 5231 14-0

Fax. +49 5231 14-2083

info@weidmueller.com
www.weidmueller.com
Technical data
Dimensions and weights

Depth	8.1 mm	Depth (inches)	0.319 inch
Height	13.3 mm	Height (inches)	0.524 inch
Height of lowest version	10.1 mm	Width	21.9 mm
Width (inches)	0.862 inch	Net weight	2.16 g

Temperatures

Operating temperature, min.	-40 °C	Operating temperature, max.	105 °C
-----------------------------	--------	-----------------------------	--------

System specifications

Product family	OMNIMATE Signal - series BL/SL 2.50	Type of connection	Board connection
Mounting onto the PCB	THT solder connection	Pitch in mm (P)	2.5 mm
Pitch in inches (P)	0.098 inch	Outgoing elbow	180°
Number of poles	8	Number of solder pins per pole	1
Solder pin length (l)	3.2 mm	Solder pin length tolerance	+0.1 / -0.1 mm
Solder pin dimensions	0.8 x 0.8 mm	Solder pin dimensions = d tolerance	+0,02 / -0,02 mm
Solder eyelet hole diameter (D)	1.3 mm	Solder eyelet hole diameter tolerance (D)	+ 0,1 mm
L1 in mm	17.5 mm	L1 in inches	6.888 inch
Number of rows	1	Pin series quantity	1
Touch-safe protection acc. to DIN VDE 57 106	finger-safe unplugged/ back-of-hand-safe plugged	Touch-safe protection acc. to DIN VDE 0470	IP20 plugged/ IP10 unplugged

Material data

Insulating material	PA 66	Colour	black
Colour chart (similar)	RAL 9011	Comparative Tracking Index (CTI)	≥ 600
UL 94 flammability rating	V-0	Contact material	Copper alloy
Contact surface	tinned	Tinning type	mat
Layer structure of solder connection	1...3 µm Ni / 4...6 µm Sn matt	Storage temperature, min.	-40 °C
Storage temperature, max.	70 °C	Operating temperature, min.	-40 °C
Operating temperature, max.	105 °C		

Rated data acc. to IEC

tested acc. to standard	IEC 61984	Rated current, min. number of poles (Tu=20°C)	6 A
Rated current, min. number of poles (Tu=40°C)	6 A	Rated voltage for surge voltage class / pollution degree II/2	320 V
Rated voltage for surge voltage class / pollution degree III/2	320 V	Rated voltage for surge voltage class / pollution degree III/3	80 V
Rated impulse voltage for surge voltage class/ pollution degree II/2	2.5 kV	Rated impulse voltage for surge voltage class/ pollution degree III/2	2.5 kV
Rated impulse voltage for surge voltage class/ contamination degree III/3	2.5 kV		

Rated data acc. to CSA

Rated voltage (Use group B / CSA)	150 V	Rated current (Use group B / CSA)	5 A
-----------------------------------	-------	-----------------------------------	-----

SL 2.50/08/180G 3.2SN BK BX

Weidmüller Interfaces GmbH & Co. KG

Postfach 3030

32760 Detmold

Tel. +49 5231 14-0

Fax. +49 5231 14-2083

info@weidmueller.com

Technical data

Rated data acc. to UL 1059

Institute (cURus)



Certificate No. (cURus) www.weidmueller.com

E60693

Rated voltage (Use group B / UL 1059) 150 V

Rated current (Use group B / UL 1059) 5 A

Reference to approval values Specifications are maximum values, details - see approval certificate.

Packing

Packaging	Box	VPE length	178 mm
VPE width	140 mm	VPE height	50 mm

Classifications

ETIM 6.0	EC002637	ETIM 7.0	EC002637
ETIM 8.0	EC002637	ECLASS 9.0	27-44-04-02
ECLASS 9.1	27-44-04-02	ECLASS 10.0	27-44-04-02
ECLASS 11.0	27-46-02-01	ECLASS 12.0	27-46-02-01

Important note

IPC conformity Conformity: The products are developed, manufactured and delivered according international recognized standards and norms and comply with the assured properties in the data sheet resp. fulfill decorative properties in accordance with IPC-A-610 "Class 2". Further claims on the products can be evaluated on request.

- Notes
- Rated current related to rated cross-section & min. No. of poles.
 - P on drawing = pitch
 - Rated data refer only to the component itself. Clearance and creepage distances to other components are to be designed in accordance with the relevant application standards.
 - Long term storage of the product with average temperature of 50 °C and average humidity 70%, 36 months

Approvals

Approvals



ROHS	Conform
UL File Number Search	UL Website
Certificate No. (cURus)	E60693

SL 2.50/08/180G 3.2SN BK BX**Weidmüller Interfaces GmbH & Co. KG**

Postfach 3030

32760 Detmold

Tel. +49 5231 14-0

Fax. +49 5231 14-2083

info@weidmueller.comwww.weidmueller.com**Technical data****Downloads**

Engineering Data	CAD data – STEP	www.weidmueller.com
Engineering Data	WSCAD, EPLAN	
Catalogues	Catalogues in PDF-format	
Brochures	FL DRIVES EN MB DEVICE MANUF. EN FL DRIVES DE FL BUILDING SAFETY EN FL APPL LED LIGHTING EN FLIndustr.CONTROLS EN FL MACHINE SAFETY EN FL HEATING ELECTR EN FL APPL INVERTER EN FL_BASE_STATION_EN FL ELEVATOR EN FL POWER SUPPLY EN FL 72H SAMPLE SER EN PO OMNIMATE EN	

SL 2.50/08/180G 3.2SN BK BX

Weidmüller Interfaces GmbH & Co. KG

Postfach 3030

32760 Detmold

Tel. +49 5231 14-0

Fax. +49 5231 14-2083

Drawings

Dimensional drawing info@weidmueller.com

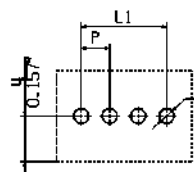
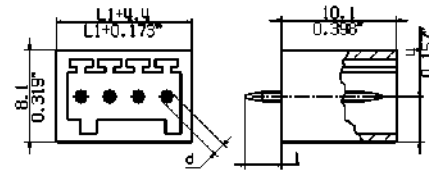

SL 2.50/08/180G 3.2SN BK BX**Weidmüller Interfaces GmbH & Co. KG**

Postfach 3030

32760 Detmold

Tel. +49 5231 14-0

Fax. +49 5231 14-2083

info@weidmueller.comwww.weidmueller.com**Drawings****Product benefits**

Operating safety
Through PUSH IN connection system

MASSE OHNE TOLERANZ SIND KEINE PRUEFMASSE
 DIMS. WITHOUT TOLERANCE ARE NOT CONTROL DIMS.

DIE DEUTSCHE VERSION IST VERBINDLICH
 THE GERMAN VERSION IS BINDING

SHOWN: SL 2.50/04/180 3.2SN

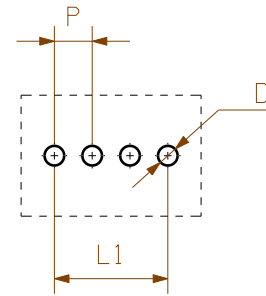
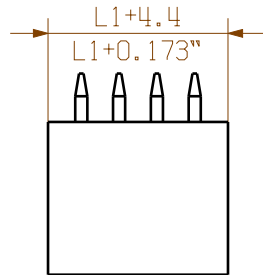
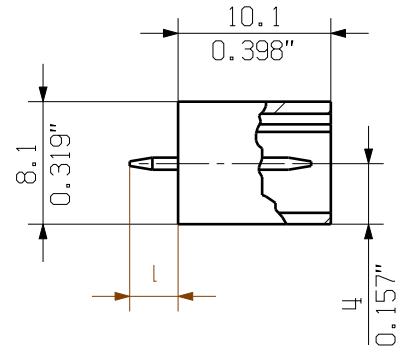
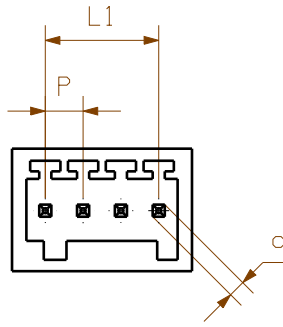

HOLE PATTERN

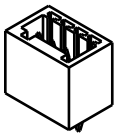

1:1

WEITERGABE SOWIE Vervielfaeltigung dieses Dokuments, Verwertung und Mitteilung seines Inhalts sind verboten, soweit nicht ausdru cklich gestattet.
 ZUWIDERHANDLUNGEN VERPFLICHTEN ZU SCHADENERSATZ. ALLE RECHTE FUER DEN FALL DER PATENT-, GEBRAUCHSMUSTER- ODER GESCHMACKSMUSTEREINTRAGUNG VORBEHALTEN.
 THE REPRODUCTION, DISTRIBUTION AND UTILIZATION OF THIS DOCUMENT AS WELL AS THE COMMUNICATION OF ITS CONTENTS TO OTHERS WITHOUT EXPLICIT AUTHORIZATION IS PROHIBITED.
 OFFENDERS WILL BE HELD LIABLE FOR THE PAYMENT OF DAMAGES. WEIDMUELLER EXCLUSIVELY RESERVES THE RIGHT TO FILE FOR PATENTS, UTILITY MODELS OR DESIGNS.
 © WEIDMUELLER INTERFACE GmbH & Co. KG

For the mounting of PCBs, it should be noted that the rated data given in the catalogue relates only to the connection elements. The necessary creepage and clearance paths must be observed in connection with the respective applicant in accordance to VDE 0110. The current-carrying capacity and pitch tolerance is to be determined according to DIN IEC 326 part 3 very fine.

Weidmüller connectors are tested to the DIN VDE 0627 standard, and are valid for its field of application. Provided that the connectors are used to the intended purpose, all requirements with respect to the occurring of electrical, mechanical, thermic and corrosive stress will be satisfied.

n = POLZAHL/NO OF POLS

$$L1 = (n-1) \times P$$

P = 2.50mm RASTER
 0,098" PITCH

D = Ø1.3 +0.1
 0.051"

d = 1.0, OKTAGONAL
 0.039"

l = 3.2
 0.126"

12	27,50	1,083
11	25,00	0,984
10	22,50	0,886
9	20,00	0,787
8	17,50	0,689
7	15,00	0,591
6	12,50	0,492
5	10,00	0,394
4	7,50	0,295
3	5,00	0,197
2	2,50	0,098
n	L [mm]	L [Inch]

GENERAL TOLERANCE:
 DIN ISO 2768-mH



MAX. NRN./NOS.

86553/0
 02.03.16 AMANN_A 00

MODIFICATION

Weidmüller

CAT.NO.: . . .
4 63329

00

DRAWING NO. SHEET 00 OF 00 SHEETS
 ISSUE NO.



	DATE	NAME
DRAWN	19.02.2016	AMANN_A
RESPONSIBLE		AMANN_A
CHECKED	02.03.2016	HELIS_MA
APPROVED		LANG_T

SL 2.50/02-12/180/..
 STIFTLAISTE
 MALE HEADER

SCALE: 2:1

SUPERSEDES: .

PRODUCT FILE: SL/BLF 2.50

7414

Recommended wave soldering profiles

Weidmüller Interface GmbH & Co. KG
 Klängenbergstraße 16
 D-32758 Detmold
 Germany
 Fon: +49 5231 14-0
 Fax: +49 5231 14-292083
 www.weidmueller.com

Single Wave:



Double Wave:



Wave soldering profiles

Wired connection elements should be processed in accordance with the DIN EN 61760-1 standard. We have included two recommendations for practical wave soldering profiles, with which Weidmüller PCB terminals and connectors are qualified.

When choosing a suitable profile for your application, the following factors also need to be considered:

- PCB thickness
- Proportion of Cu in the layers
- Single/double-sided assembly
- Product range
- Heating and cooling rates

The single and double wave profiles each indicate the recommended operating range, including the maximum soldering temperature of 260°C. In practice, the maximum soldering temperature is quite often well below the above maximum profile.