

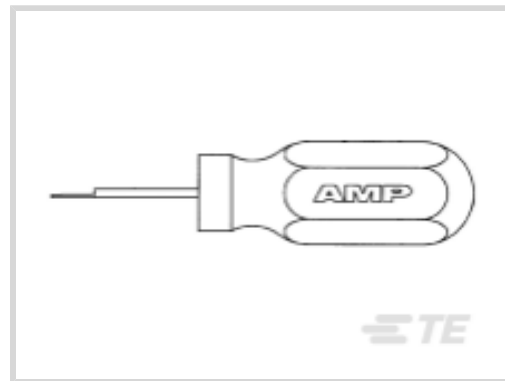

Application Tooling > Insertion & Extraction Tools



Insertion & Extraction Tool Type: **Contact Extraction**

Insertion & Extraction Tool Application: **Contact-to-Housing**

Features

Product Type Features

Insertion & Extraction Tool Type	Contact Extraction
Insertion & Extraction Tool Application	Contact-to-Housing

Product Compliance

[For compliance documentation, visit the product page on TE.com>](#)

EU RoHS Directive 2011/65/EU	Out of Scope
EU ELV Directive 2000/53/EC	Out of Scope
China RoHS 2 Directive MIIT Order No 32, 2016	Not reviewed for China RoHS compliance
EU REACH Regulation (EC) No. 1907/2006	Current ECHA Candidate List: JUNE 2024 (241) Candidate List Declared Against: JUL 2021 (219) Does not contain REACH SVHC
Halogen Content	Not Yet Reviewed for halogen content
Solder Process Capability	Not applicable for solder process capability

Product Compliance Disclaimer

This information is provided based on reasonable inquiry of our suppliers and represents our current actual knowledge based on the information they provided. This information is subject to change. The part numbers that TE has identified as EU RoHS compliant have a maximum concentration of 0.1% by weight in homogenous materials for lead, hexavalent chromium, mercury, PBB, PBDE, DBP, BBP, DEHP, DIBP, and 0.01% for cadmium, or qualify for an exemption to these limits as defined in the Annexes of Directive 2011/65/EU (RoHS2). Finished electrical and electronic equipment products will be CE marked as required by Directive 2011/65/EU. Components may not be CE marked. Additionally, the part numbers that TE has identified as EU ELV compliant have a maximum concentration of 0.1% by weight in homogenous materials for lead, hexavalent chromium, and mercury, and 0.01% for cadmium, or qualify for an exemption to these limits as defined in the Annexes of Directive 2000/53/EC (ELV). Regarding the REACH Regulation, the information TE provides

on SVHC in articles for this part number is based on the latest European Chemicals Agency (ECHA) 'Guidance on requirements for substances in articles' posted at this URL: <https://echa.europa.eu/guidance-documents/guidance-on-reach>

Compatible Parts



TE Part # CAT-SI261-C1701A
Glow Wire Signal Double Lock Cap



TE Part # CAT-SI261-P729A
Glow Wire Signal Double Lock Plug



TE Part # CAT-SI261-C1701
STD Temp Signal Double Lock Cap



TE Part # CAT-SI261-P729
STD Temp Signal Double Lock Plug



TE Part # CAT-SI261-T669
Signal Double Lock TPA



TE Part # CAT-SI261-T111
Signal Double Lock Tab



TE Part # CAT-SI261-R2435
Signal Double Lock Receptacle



TE Part # 917701-1
2.5 SIGNAL DBL LOCK DLP 5P



TE Part # 5-917690-1
2.5 SIGNAL D/LOCK PLUG HSG 6P



TE Part # 5-917698-1
2.5 SIGNAL DBL LOCK D.L.P 2P



TE Part # 316398-1
2.5 SIGNAL D/L TAB CONT. L L/P



TE Part # 316399-1
2.5 SIGNAL D/L TAB CONT. M L/P



TE Part # 316401-1
2.5 SIGNAL D/L REC CONT. M L/P



TE Part # 917687-6
2.5 SIGNAL D/LOCK PLUG HSG 3P



TE Part # 917693-4
2.5 S.D.L PLUG HSG 9P YELLOW



TE Part # 316094-2
2.5 S.D.L. CAP HSG 10P RED



Also in the Series | AMP Signal Double Lock

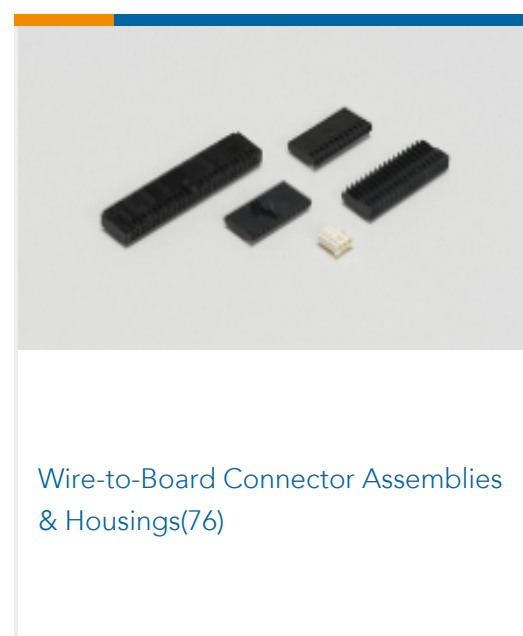
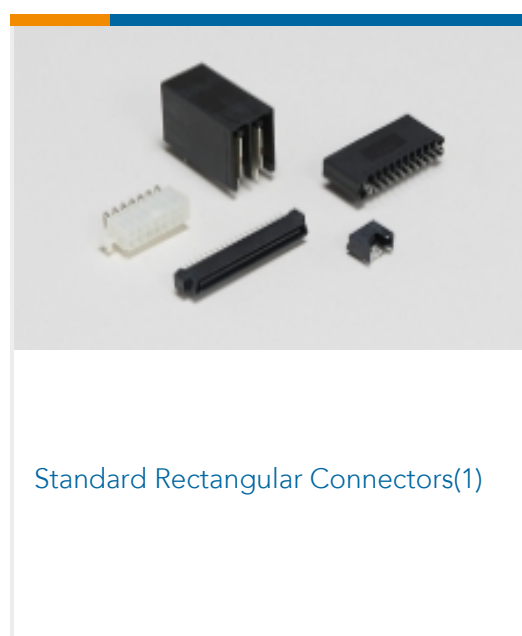
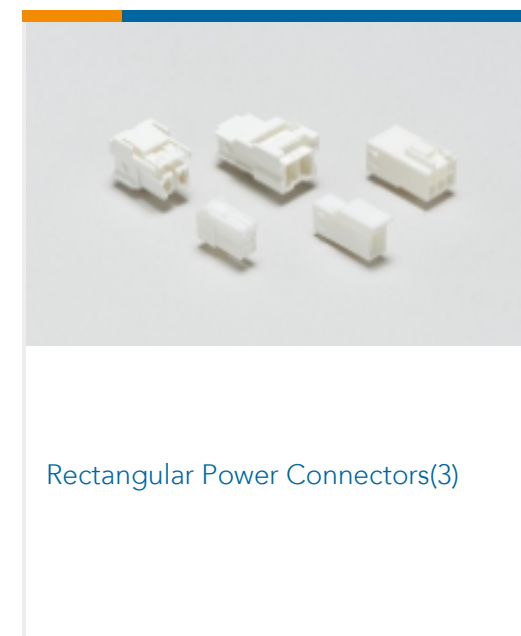
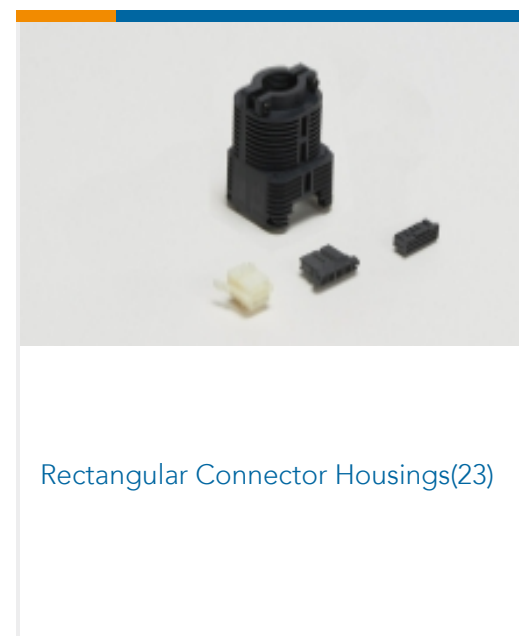
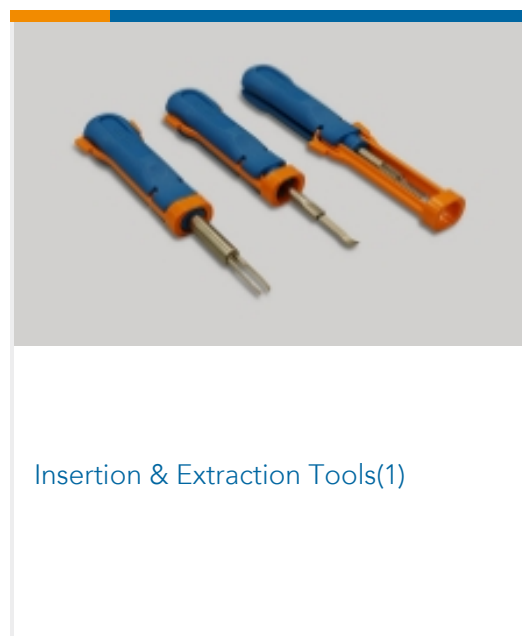
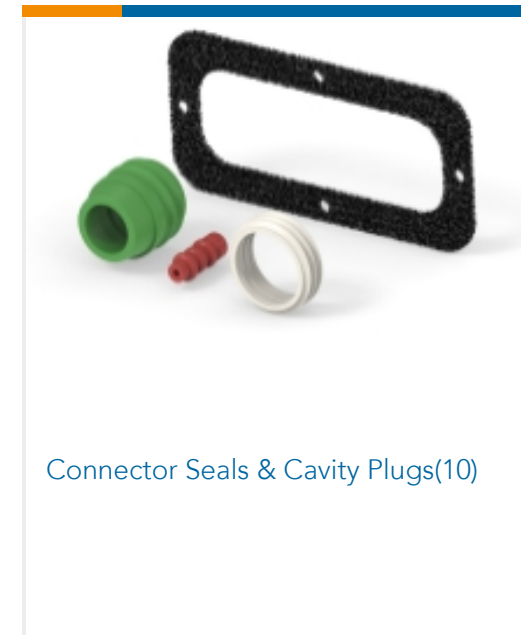
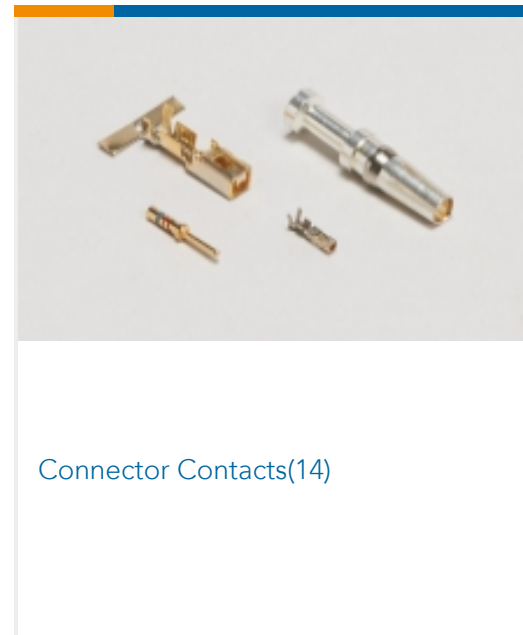
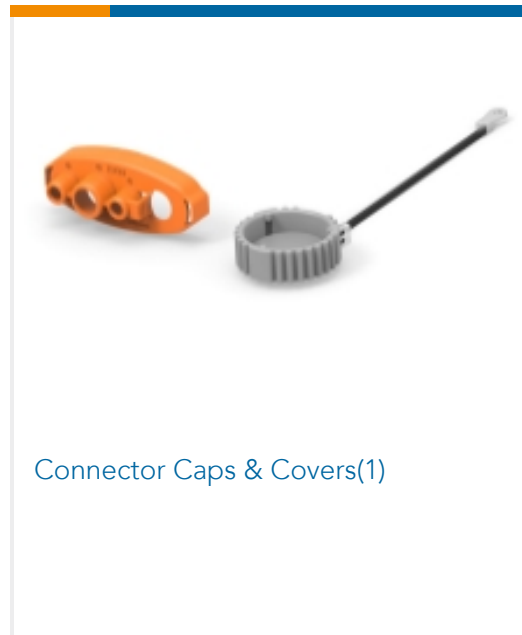

Customers Also Bought



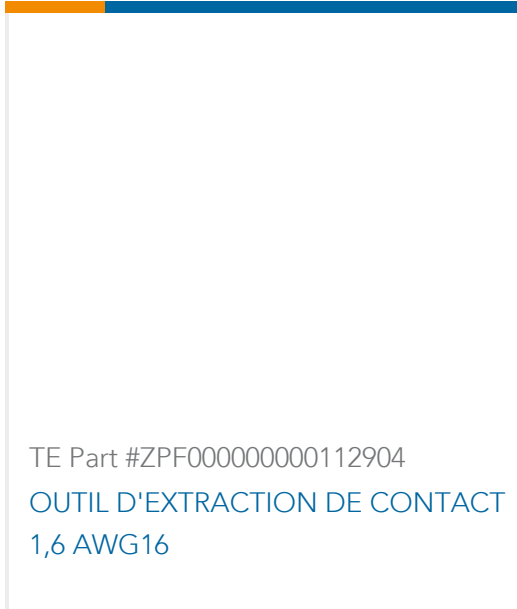
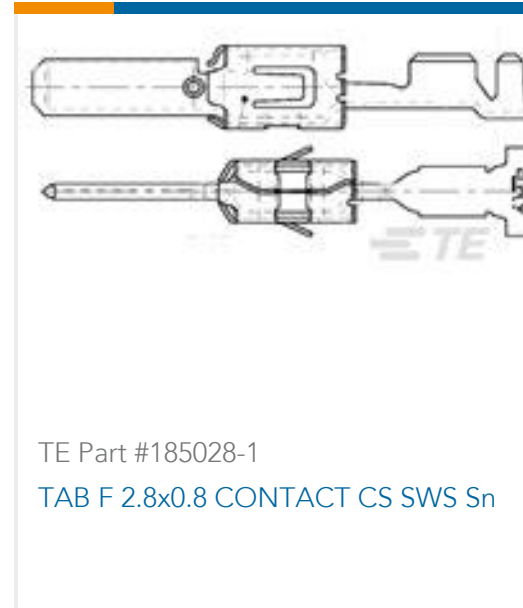

Documents

Instruction Sheets

EXTRACTION TOOL FOR AMP* SIGNAL DOUBLE LOCK CONNECTOR 234605-1

English

Instruction Sheet (non U.S.)

English