

Data sheet | Item number: 234-216

PCB terminal block; push-button; 0.5 mm²; Pin spacing 2.5 mm; 16-pole;
CAGE CLAMP®; 0,50 mm²; gray

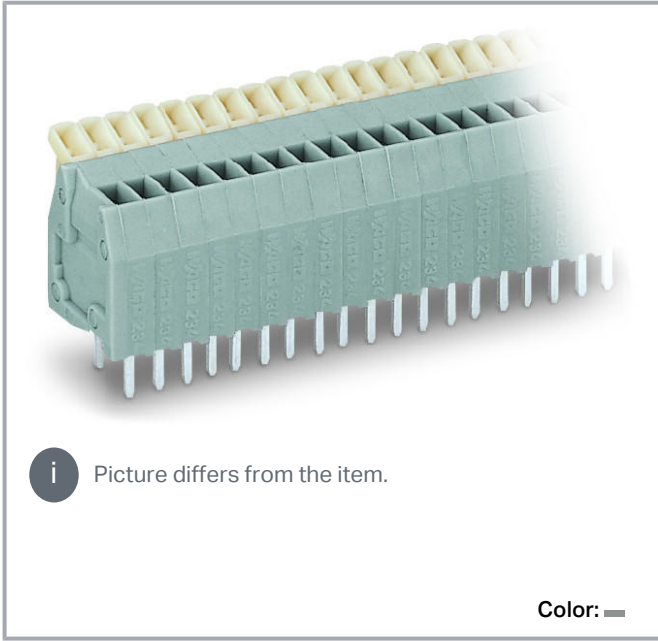

www.wago.com/234-216



i Picture differs from the item.

Color:

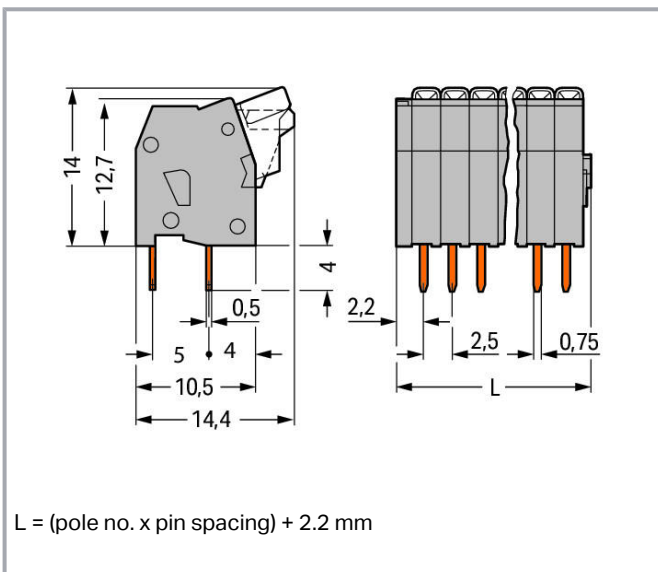
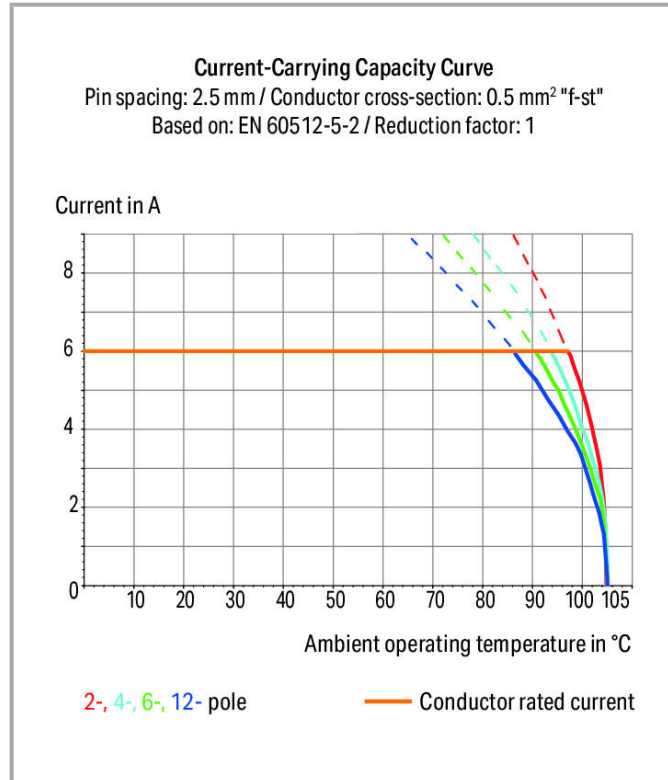

Subject to changes. Please also observe the further product documentation!

WAGO Kontakttechnik GmbH & Co. KG
Hansastr. 27
32423 Minden
Phone: +49571 887-0 | Fax: +49571 887-169
Email: info.de@wago.com | Web: www.wago.com

Do you have any questions about our products?
We are always happy to take your call at +49 (571) 887-44222.



Item description

- PCB terminal strips with push-buttons and CAGE CLAMP® connection
- Double solder pins for high mechanical stability on PCB
- Ideal for in-the-field wiring thanks to simplified push-button actuation
- Convenient, tool-free operation

Data

Electrical data

Ratings per IEC/EN

Ratings per	IEC/EN 60664-1
Nominal voltage (III/3)	63 V
Rated surge voltage (III/3)	2.5 kV
Rated voltage (III/2)	160 V
Rated surge voltage (III/2)	2.5 kV
Nominal voltage (II/2)	320 V
Rated surge voltage (II/2)	2.5 kV
Rated current	6 A
Legend (ratings)	(III / 2) ≙ Overvoltage category III / Pollution degree 2

Ratings per UL

Approvals per	UL 1059
Rated voltage UL (Use Group B)	150 V
Rated current UL (Use Group B)	4 A

Ratings per CSA

Approvals per	CSA
Rated voltage CSA (Use Group B)	150 V
Rated current CSA (Use Group B)	4 A

Connection data

Connection technology	CAGE CLAMP®
Actuation type	Push-button
Solid conductor	0.08 ... 0.5 mm ² / 28 ... 20 AWG
Fine-stranded conductor	0.08 ... 0.5 mm ² / 28 ... 20 AWG

Subject to changes. Please also observe the further product documentation!



Fine-stranded conductor; with insulated ferrule	0.25 mm ²
Fine-stranded conductor; with uninsulated ferrule	0.25 mm ²
Strip length	5 ... 6 mm / 0.2 ... 0.24 inch
Conductor connection direction to PCB	90°
Pole No.	16
Total number of connection points	16
Total number of potentials	16
Number of connection types	1
Number of levels	1

Physical data

Pin spacing	2.5 mm / 0.098 inch
Width	42.2 mm / 1.661 inch
Height	18 mm / 0.709 inch
Height from the surface	14 mm / 0.551 inch
Depth	14.4 mm / 0.567 inch
Solder pin length	4 mm
Solder pin dimensions	0.5 x 0.75 mm
Drilled hole diameter with tolerance	1.1 (+0.1) mm

PCB contact

PCB Contact	THT
Solder pin arrangement	over the entire terminal strip (in-line)
Number of solder pins per potential	2

Material data

Color	gray
Material group	I
Insulation material	Polyamide (PA66)
Flammability class per UL94	V0
Clamping spring material	Chrome nickel spring steel (CrNi)
Contact material	Electrolytic copper (E _{Cu})
Contact plating	tin-plated
Fire load	0.116 MJ
Weight	8.1 g

Subject to changes. Please also observe the further product documentation!

Environmental requirements





Limit temperature range -60 ... +105 °C

Commercial data

Product Group	4 (Printed Circuit)
Packaging type	BOX
Country of origin	CH
GTIN	4044918651622
Customs tariff number	85369010000

Approvals / Certificates

Country specific Approvals

Logo	Approval	Additional Approval Text	Certificate name
	CCA DEKRA Certification B.V.	EN 60998	NTR NL 6946
	CCA DEKRA Certification B.V.	EN 60998	2153951.01
	CCA DEKRA Certification B.V.	EN 60947-7-4	NTR NL 7787
	CSA DEKRA Certification B.V.	C22.2	1465035
	KEMA/KEUR DEKRA Certification B.V.	EN 60947-7-4	71-111042

Ship Approvals

Logo	Approval	Additional Approval Text	Certificate name
	ABS American Bureau of Shipping	-	19- HG1869876- PDA

Subject to changes. Please also observe the further product documentation!



BV
Bureau Veritas S.A.

IEC 60998

11915/DO
BV

DNV GL
Det Norske Veritas, Germanischer Lloyd

-





TAE000016Z

UL-Approvals

Logo	Approval	Additional Approval Text	Certificate name
	UL UL International Germany GmbH	UL 1059	20190731- E45172

Optional accessories

Ferrule

	Item no.: 216-131 Ferrule; Sleeve for 0.25 mm ² / AWG 24; uninsulated; electro-tin plated; silver-colored	www.wago.com/216-131
	Item no.: 216-151 Ferrule; Sleeve for 0.25 mm ² / AWG 24; uninsulated; electro-tin plated	www.wago.com/216-151
	Item no.: 216-301 Ferrule; Sleeve for 0.25 mm ² / AWG 24; insulated; electro-tin plated; yellow	www.wago.com/216-301
	Item no.: 216-321 Ferrule; Sleeve for 0.25 mm ² / AWG 24; insulated; electro-tin plated; yellow	www.wago.com/216-321

Marking accessories

	Item no.: 210-331/250-202 Marking strips; as a DIN A4 sheet; MARKED; 1-16 (400x); Height of marker strip: 2.3 mm/0.091 in; Strip length 182 mm; Horizontal marking; Self-adhesive; white	www.wago.com/210-331/250-202
	Item no.: 210-331/250-204 Marking strips; as a DIN A4 sheet; MARKED; 17-32 (400x); Height of marker strip: 2.3 mm/0.091 in; Strip length 182 mm; Horizontal marking; Self-adhesive; white	www.wago.com/210-331/250-204
	Item no.: 210-331/250-206 Marking strips; as a DIN A4 sheet; MARKED; 33-48 (400x); Height of marker strip: 2.3 mm/0.091 in; Strip length 182 mm; Horizontal marking; Self-adhesive; white	www.wago.com/210-331/250-206

Subject to changes. Please also observe the further product documentation!

WAGO Kontakttechnik GmbH & Co. KG
Hansastr. 27
32423 Minden
Phone: +49571 887-0 | Fax: +49571 887-169
Email: info.de@wago.com | Web: www.wago.com

Do you have any questions about our products?
We are always happy to take your call at +49 (571) 887-44222.

length 182 mm; Horizontal marking; Self-adhesive; white

Item no.: 210-331/250-207

Marking strips; as a DIN A4 sheet; MARKED; 1-48 (100x); Height of marker strip: 2.3 mm/0.091 in; Strip length 182 mm; Horizontal marking; Self-adhesive; white

www.wago.com/210-331/250-207

Tool



Item no.: 210-648

Operating tool; Blade: 2.5 x 0.4 mm; with a partially insulated shaft; angled; short

www.wago.com/210-648



Item no.: 210-719

Operating tool; Blade: 2.5 x 0.4 mm; with a partially insulated shaft

www.wago.com/210-719

Downloads

Documentation

Additional Information

Technical explanations

2019 Apr 3

pdf
2.0 MB

[Download](#)

CAD/CAE-Data

CAD data

2D/3D Models 234-216

[URL](#)

[Download](#)

PCB Design

Symbol and Footprint 234-216

[URL](#)

[Download](#)

CAX data for your PCB design, consisting of "schematic symbols and PCB footprints", allow easy integration of the WAGO component into your development environment.

Supported formats:

- Accel EDA 14 & 15
- Altium 6 to current version
- Cadence Allegro
- DesignSpark
- Eagle Libraries
- KiCad
- Mentor Graphics BoardStation
- Mentor Graphics Design Architect
- Mentor Graphics Design Expedition 99 and 2000
- OrCAD 9.X PCB and Capture

Subject to changes. Please also observe the further product documentation!

WAGO Kontakttechnik GmbH & Co. KG

Hansastr. 27

32423 Minden

Phone: +49571 887-0 | Fax: +49571 887-169

Email: info.de@wago.com | Web: www.wago.com

Do you have any questions about our products?

We are always happy to take your call at +49 (571) 887-44222.



- PADS PowerPCB 3, 3.5, 4.X, and 5.X
- PADS PowerPCB and PowerLogic 3.0
- PCAD 2000, 2001, 2002, 2004, and 2006
- Pulsonix 8.5 or newer
- STL
- 3D STEP
- TARGET 3001!
- View Logic ViewDraw
- Quadcept
- Zuken CadStar 3 and 4
- Zuken CR-5000 and CR-8000

PCB Component Libraries (EDA), PCB CAD Library Ultra Librarian

CAE data

EPLAN Data Portal 234-216	URL	Download
ZUKEN Portal 234-216	URL	Download

Environmental Product Compliance

Compliance Search

Environmental Product Compliance 234-216	URL	Download
PCB terminal block; push-button; 0.5 mm ² ; Pin spacing 2.5 mm; 16-pole; CAGE CLAMP®; 0,50 mm ² ; gray		

Installation Notes

Conductor termination

Subject to changes. Please also observe the further product documentation!

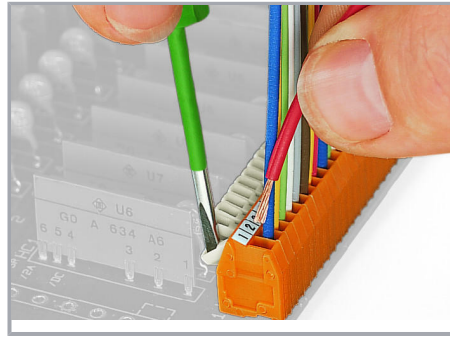

Nominal cross-section: 0.5 mm² (20 AWG),
0.75 mm² (18 AWG) only in every other
position

Inserting/removing a conductor.

Marking

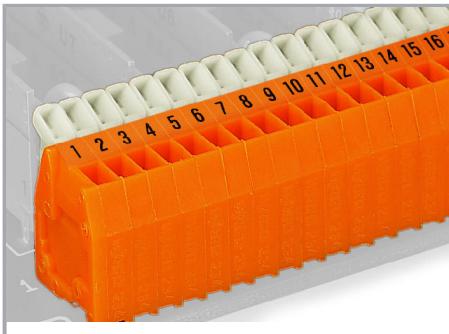

Labeling via self-adhesive marking strips or
factory direct marking.

Subject to changes. Please also observe the further product documentation!