

Data Sheet | Item Number: 231-344/001-000

THT male header; 1.0 x 1.0 mm solder pin; straight; Pin spacing 5.08 mm; 14-pole; orange

<https://www.wago.com/231-344/001-000>

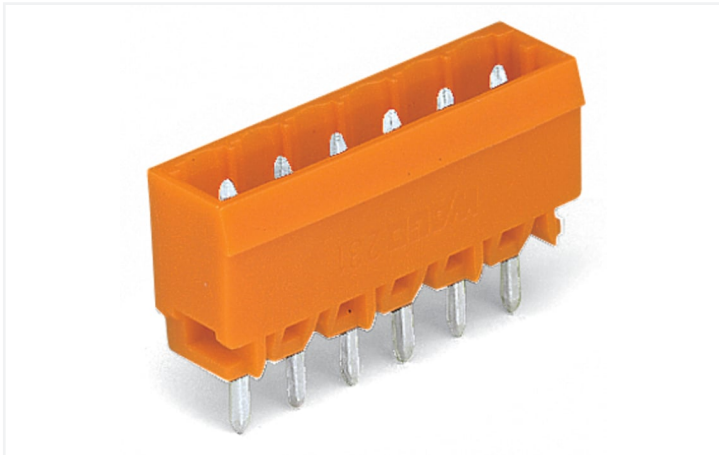

Color: ■ orange

Similar to illustration

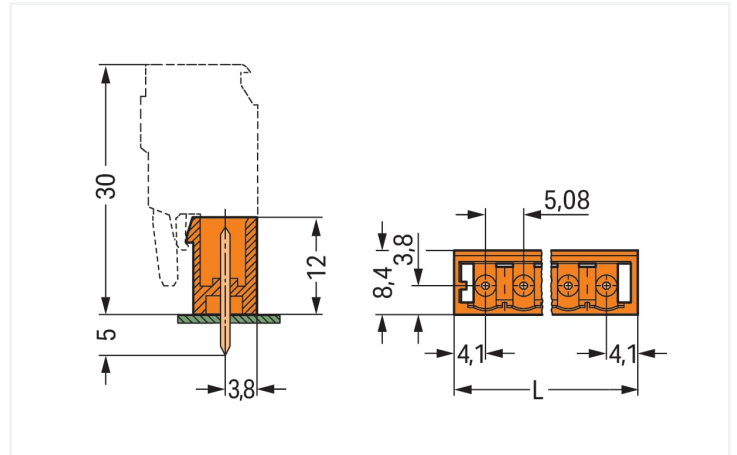

Dimensions in mm

$L = (\text{pole no.} - 1) \times \text{pin spacing} + 8.2 \text{ mm}$

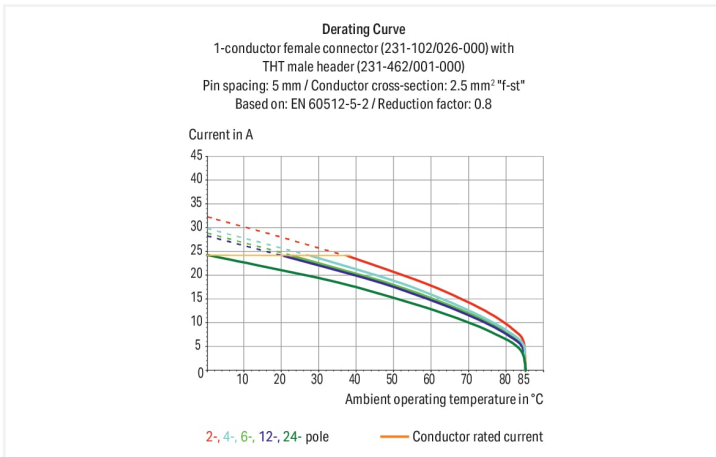

- Horizontal or vertical PCB mounting via straight or angled solder pins
- Pin cross-section: 1 x 1 mm
- With coding fingers

Notes

Safety Information

The MCS – MULTI CONNECTION SYSTEM includes connectors without breaking capacity in accordance with DIN EN 61984. When used as intended, these connectors must not be connected/disconnected when live or under load. When used as intended, these connectors must not be connected/disconnected when live or under load. The circuit design should ensure header pins, which can be touched, are not live when unmated.

Variants:

Other pole numbers

3.8 mm pin projection for male headers with straight solder pins

Gold-plated or partially gold-plated contact surfaces

Other versions (or variants) can be requested from WAGO Sales or configured at <https://configurator.wago.com/>.

Electrical data

Rated current	IEC/EN 60664-1		
Overvoltage category	III	III	II
Pollution degree	3	2	2
Nominal voltage	320 V	320 V	630 V
Rated surge voltage	4 kV	4 kV	4 kV
Rated current	12 A	12 A	12 A

Rated current	UL 1059		
Use group	B	C	D
Rated voltage	300 V	-	300 V
Rated current	10 A	-	10 A

Approvals per	UL 1977
Rated voltage	600 V
Rated current	10 A

Approvals per	CSA		
Use group	B	C	D
Rated voltage	300 V	-	300 V
Rated current	10 A	-	10 A

Connection data

Total number of potentials	14
Number of connection types	1
Number of levels	1

Connection 1

Pole number	14
-------------	----

Physical data

Pin spacing	5.08 mm / 0.2 inches
Width	74.24 mm / 2.923 inches
Height	17 mm / 0.669 inches
Height from the surface	12 mm / 0.472 inches
Depth	8.4 mm / 0.331 inches
Solder pin length	5 mm
Solder pin dimensions	1 x 1 mm
Drilled hole diameter with tolerance	1.4 ^(+0.1) mm

Mechanical data

Variable coding	Yes
Anti-rotation protection	Yes

Plug-in connection

Contact type (pluggable connector)	Male connector/plug
Connector (connection type)	for PCB
Mismating protection	No
Mating direction to the PCB	90 °

PCB contact

PCB contact	THT
Solder pin arrangement	over the entire male connector (in-line)
Number of solder pins per potential	1

Material data

Note (material data)	Information on material specifications can be found here
Color	orange
Material group	I
Insulation material (main housing)	Polyamide (PA66)
Flammability class per UL94	V0
Contact material	Electrolytic copper (E _{Cu})
Contact Plating	Tin
Fire load	0.081 MJ
Weight	4.5 g

Environmental requirements

Limit temperature range	-60 ... +100 °C
Processing temperature	-35 ... +60 °C

Environmental Testing (Environmental Conditions)

Test specification Railway applications – Rolling stock – Electronic equipment	DIN EN 50155 (VDE 0115-200):2022-06
Test procedure Railway applications – Rolling stock equipment – Shock and vibration tests	DIN EN 61373 (VDE 0115-0106):2011-04
Spectrum/Installation location	Service life test, Category 1, Class A/B
Function test with noise-like vibration	Test passed according to Section 8 of the standard
Frequency	$f_1 = 5 \text{ Hz}$ to $f_2 = 150 \text{ Hz}$ $f_1 = 5 \text{ Hz}$ to $f_2 = 150 \text{ Hz}$
Acceleration	0.101g (highest test level used for all axes) 0.572g (highest test level used for all axes) 5g (highest test level used for all axes)
Test duration per axis	10 min. 5 h
Test directions	X, Y and Z axes X, Y and Z axes X, Y and Z axes
Monitoring for contact faults/interruptions	Passed
Voltage drop measurement before and after each axis	Passed
Simulated service life test through increased levels of noise-like vibration	Test passed according to Section 9 of the standard
Extended test scope: Monitoring for contact faults/interruptions	Passed Passed
Extended test scope: Voltage drop measurement before and after each axis	Passed Passed
Shock test	Test passed according to Section 10 of the standard
Shock form	Half sine
Shock duration	30 ms
Number of shocks per axis	3 pos. und 3 neg.
Vibration and shock stress for rolling stock equipment	Passed

Commercial data

Product Group	3 (Multi Conn. System)
eCl@ss 10.0	27-44-04-02
eCl@ss 9.0	27-44-04-02
ETIM 9.0	EC002637
ETIM 8.0	EC002637
PU (SPU)	50 pcs
Packaging type	Box
Country of origin	PL
GTIN	4044918865692
Customs tariff number	85366930000

Environmental Product Compliance

RoHS Compliance Status	Compliant, No Exemption
------------------------	-------------------------

Approvals / Certificates

General approvals

Declarations of conformity and manufacturer's declarations



Approval	Standard	Certificate Name
CB DEKRA Certification B.V.	IEC 61984	NL-39756/A1
CSA DEKRA Certification B.V.	C22.2	1466354
KEMA/KEUR DEKRA Certification B.V.	EN 61984	71-121453
UL UL International Germany GmbH	UL 1977	E45171
UR Underwriters Laboratories Inc.	UL 1059	E45172

Approval	Standard	Certificate Name
Railway WAGO GmbH & Co. KG	-	Railway Ready

Approvals for marine applications



Approval	Standard	Certificate Name
ABS American Bureau of Ship- ping	-	19-HG1869876-PDA

Downloads

Environmental Product Compliance

Compliance Search	
Environmental Product Compliance 231-344/001-000	↓

Documentation

Additional Information			
Technical Section	03.04.2019	pdf 2027.26 KB	↓

CAD/CAE-Data

CAD data

2D/3D Models
231-344/001-000 

CAE data

EPLAN Data Portal
231-344/001-000 

ZUKEN Portal
231-344/001-000 

PCB Design

Symbol and Footprint
via SamacSys
231-344/001-000 

Symbol and Footprint
via Ultra Librarian
231-344/001-000 

1 Compatible Products

1.1 System counterpart

1.1.1 Female connector/socket



Item No.: 232-314/026-000
1-conductor female connector, angled; CAGE CLAMP®; 2.5 mm²; Pin spacing 5.08 mm; 14-pole; 2,50 mm²; orange



Item No.: 232-414/026-000
1-conductor female connector, angled; CAGE CLAMP®; 2.5 mm²; Pin spacing 5.08 mm; 14-pole; 2,50 mm²; orange



Item No.: 231-314/026-000
1-conductor female connector; CAGE CLAMP®; 2.5 mm²; Pin spacing 5.08 mm; 14-pole; 2,50 mm²; orange



Item No.: 231-314/027-000
1-conductor female connector; CAGE CLAMP®; 2.5 mm²; Pin spacing 5.08 mm; 14-pole; clamping collar; 2,50 mm²; orange



Item No.: 231-314/031-000
1-conductor female connector; CAGE CLAMP®; 2.5 mm²; Pin spacing 5.08 mm; 14-pole; clamping collar; 2,50 mm²; orange



Item No.: 231-314/037-000
1-conductor female connector; CAGE CLAMP®; 2.5 mm²; Pin spacing 5.08 mm; 14-pole; Lateral locking levers; 2,50 mm²; orange



Item No.: 231-314/102-000
1-conductor female connector; CAGE CLAMP®; 2.5 mm²; Pin spacing 5.08 mm; 14-pole; with integrated end plate; 2,50 mm²; orange



Item No.: 2231-314/026-000
1-conductor female connector; push-button; Push-in CAGE CLAMP®; 2.5 mm²; Pin spacing 5.08 mm; 14-pole; 2,50 mm²; orange



Item No.: 2231-314/031-000
1-conductor female connector; push-button; Push-in CAGE CLAMP®; 2.5 mm²; Pin spacing 5.08 mm; 14-pole; clamping collar; 2,50 mm²; orange



Item No.: 2231-314/037-000
1-conductor female connector; push-button; Push-in CAGE CLAMP®; 2.5 mm²; Pin spacing 5.08 mm; 14-pole; Lateral locking levers; 2,50 mm²; orange



Item No.: 2231-314/102-000
1-conductor female connector; push-button; Push-in CAGE CLAMP®; 2.5 mm²; Pin spacing 5.08 mm; 14-pole; with integrated end plate; 2,50 mm²; orange



Item No.: 231-2314/037-000
2-conductor female connector; Push-in CAGE CLAMP®; 2.5 mm²; Pin spacing 5.08 mm; 14-pole; Lateral locking levers; 2,50 mm²; orange



Item No.: 231-2314/026-000
2-conductor female connector; Push-in CAGE CLAMP®; 2.5 mm²; Pin spacing 5.08 mm; 14-pole; with integrated end plate; 2,50 mm²; orange

1.2 Optional Accessories

1.2.1 Coding

1.2.1.1 Coding



Item No.: [231-129](#)

Coding key; snap-on type; light gray

1.2.1.2 Intermediate plate



Item No.: [231-500](#)

Spacer; for formation of groups; light gray

Installation Notes

Coding

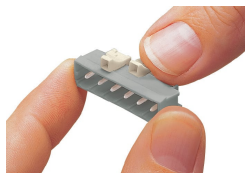

Coding a male header – fitting coding key (s).