

Data Sheet | Item Number: 231-108/008-000

1-conductor female connector; CAGE CLAMP®; 2.5 mm²; Pin spacing 5 mm; 8-pole;
Snap-in mounting feet; 2,50 mm²; gray

<https://www.wago.com/231-108/008-000>



Color: ■ gray

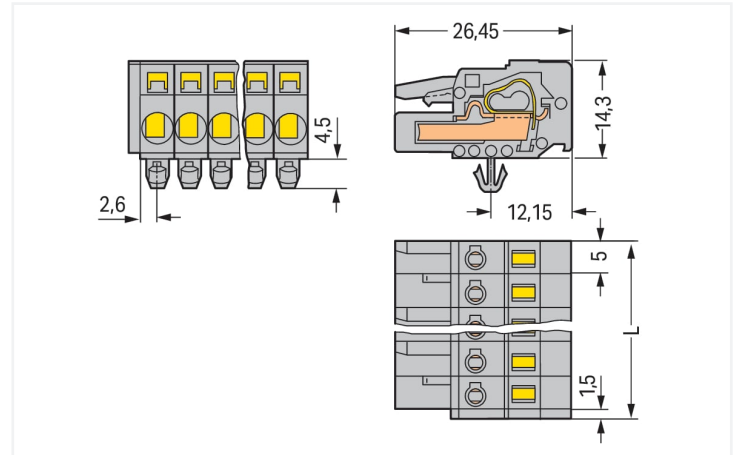

Dimensions in mm

$L = (\text{pole no.} \times \text{pin spacing}) + 1.5 \text{ mm}$

2- to 3-pole female connectors – one latch only

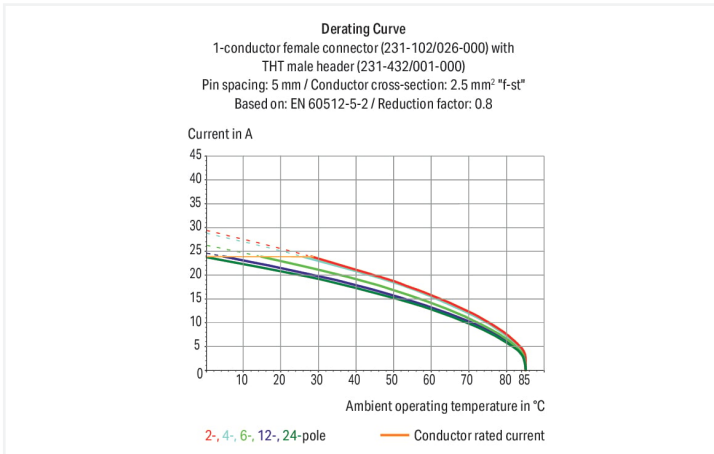

- Universal connection for all conductor types
- Easy cable pre-assembly and on-unit wiring via vertical and horizontal CAGE CLAMP® actuation
- Integrated test ports
- With coding fingers

Notes

Safety Information

The MCS – MULTI CONNECTION SYSTEM includes connectors without breaking capacity in accordance with DIN EN 61984. When used as intended, these connectors must not be connected/disconnected when live or under load. When used as intended, these connectors must not be connected/disconnected when live or under load. The circuit design should ensure header pins, which can be touched, are not live when unmated.

Variants:

Gold-plated or partially gold-plated contact surfaces

Other versions (or variants) can be requested from WAGO Sales or configured at <https://configurator.wago.com/>.

Electrical data

Ratings per	IEC/EN 60664-1		
Overvoltage category	III	III	II
Pollution degree	3	2	2
Nominal voltage	320 V	320 V	630 V
Rated surge voltage	4 kV	4 kV	4 kV
Rated current	16 A	16 A	16 A

Approvals per	UL 1059		
Use group	B	C	D
Rated voltage	300 V	-	300 V
Rated current	15 A	-	10 A

Approvals per	UL 1977
Rated voltage	600 V
Rated current	15 A

Approvals per	CSA		
Use group	B	C	D
Rated voltage	300 V	-	300 V
Rated current	15 A	-	10 A

Connection data

Clamping units	8
Total number of potentials	8
Number of connection types	1
Number of levels	1

Connection 1	
Connection technology	CAGE CLAMP®
Actuation type	Operating tool
Actuation direction 1	Operation parallel to conductor entry
Actuation direction 2	Operation perpendicular to conductor entry
Solid conductor	0.08 ... 2.5 mm ² / 28 ... 12 AWG
Fine-stranded conductor	0.08 ... 2.5 mm ² / 28 ... 12 AWG
Fine-stranded conductor; with insulated ferrule	0.25 ... 1.5 mm ²
Fine-stranded conductor; with uninsulated ferrule	0.25 ... 2.5 mm ²
Strip length	8 ... 9 mm / 0.31 ... 0.35 inches
Pole number	8
Conductor entry direction to mating direction	0°

Physical data

Pin spacing	5 mm / 0.197 inches
Width	41.5 mm / 1.634 inches
Height	18.8 mm / 0.74 inches
Height from the surface	14.3 mm / 0.563 inches
Depth	26.5 mm / 1.043 inches
Drilled hole diameter for snap-in mounting foot with tolerance	3.5 ^(+0.1) mm

Mechanical data

Variable coding	Yes
Housing sheet thickness	0.6 ... 1.2 mm / 0.024 ... 0.047 inches
Mounting type	Snap-in foot Panel mounting
Anti-rotation protection	Yes

Plug-in connection

Contact type (pluggable connector)	Female connector/socket
Connector (connection type)	for conductor
Mismating protection	No

Material data

Note (material data)	Information on material specifications can be found here
Color	gray
Material group	I
Insulation material (main housing)	Polyamide (PA66)
Flammability class per UL94	V0
Clamping spring material	Chrome-nickel spring steel (CrNi)
Contact material	Copper alloy
Contact Plating	Tin
Fire load	0.276 MJ
Weight	14.5 g

Environmental requirements

Limit temperature range	-60 ... +85 °C
Processing temperature	-35 ... +60 °C

Environmental Testing (Environmental Conditions)

Test specification Railway applications – Rolling stock – Electronic equipment	DIN EN 50155 (VDE 0115-200):2022-06
Test procedure Railway applications – Rolling stock equipment – Shock and vibration tests	DIN EN 61373 (VDE 0115-0106):2011-04
Spectrum/Installation location	Service life test, Category 1, Class A/B
Function test with noise-like vibration	Test passed according to Section 8 of the standard
Frequency	$f_1 = 5 \text{ Hz to } f_2 = 150 \text{ Hz}$ $f_1 = 5 \text{ Hz to } f_2 = 150 \text{ Hz}$
Acceleration	0.101g (highest test level used for all axes) 0.572g (highest test level used for all axes) 5g (highest test level used for all axes)
Test duration per axis	10 min. 5 h
Test directions	X, Y and Z axes X, Y and Z axes X, Y and Z axes
Monitoring for contact faults/interruptions	Passed
Voltage drop measurement before and after each axis	Passed
Simulated service life test through increased levels of noise-like vibration	Test passed according to Section 9 of the standard
Extended test scope: Monitoring for contact faults/interruptions	Passed Passed
Extended test scope: Voltage drop measurement before and after each axis	Passed Passed
Shock test	Test passed according to Section 10 of the standard
Shock form	Half sine
Shock duration	30 ms
Number of shocks per axis	3 pos. und 3 neg.
Vibration and shock stress for rolling stock equipment	Passed

Commercial data	
Product Group	3 (Multi Conn. System)
eCl@ss 10.0	27-44-03-09
eCl@ss 9.0	27-44-03-09
ETIM 9.0	EC002638
ETIM 8.0	EC002638
PU (SPU)	50 pcs
Packaging type	Box
Country of origin	DE
GTIN	4044918339865
Customs tariff number	85366990990

Environmental Product Compliance	
RoHS Compliance Status	Compliant, No Exemption

Approvals / Certificates

General approvals



Approval	Standard	Certificate Name
CB DEKRA Certification B.V.	IEC 61984	NL-39756/A1
CSA DEKRA Certification B.V.	C22.2	LR 18677-25
KEMA/KEUR DEKRA Certification B.V.	EN 61984	71-121453
UL Underwriters Laboratories Inc.	UL 1059	E45172
UR Underwriters Laboratories Inc.	UL 1977	E45171

Declarations of conformity and manufacturer's declarations



Approval	Standard	Certificate Name
Railway WAGO GmbH & Co. KG	-	Railway Ready

Approvals for marine applications



Approval	Standard	Certificate Name
ABS American Bureau of Shipping	-	19-HG1869876-PDA
BV Bureau Veritas S.A.	IEC 60998	11915/D0 BV
DNV DNV GL SE	-	TAE000016Z

Downloads

Environmental Product Compliance

Compliance Search

Environmental Product
Compliance
231-108/008-000



Documentation

Additional Information

Technical Section

03.04.2019

pdf

2027.26 KB



CAD/CAE-Data

CAD data

2D/3D Models
231-108/008-000



CAE data

EPLAN Data Portal
231-108/008-000



ZUKEN Portal
231-108/008-000



1 Compatible Products

1.1 System counterpart

1.1.1 Male connector/plug



Item No.: 231-608

1-conductor male connector; CAGE
CLAMP®; 2.5 mm²; Pin spacing 5 mm; 8-
pole; 2,50 mm²; gray

1.2 Optional Accessories

1.2.1 Cover

1.2.1.1 Cover



Item No.: 231-668

Lockout caps; for covering unused clam-
ping units; gray

1.2.2 Ferrule

1.2.2.1 Ferrule



Item No.: 216-301

Ferrule; Sleeve for 0.25 mm² / AWG 24; insulated; electro-tin plated; yellow



Item No.: 216-302

Ferrule; Sleeve for 0.34 mm² / 22 AWG; insulated; electro-tin plated; light turquoise



Item No.: 216-241

Ferrule; Sleeve for 0.5 mm² / 20 AWG; insulated; electro-tin plated; electrolytic copper; gastight crimped; acc. to DIN 46228, Part 4/09.90; white



Item No.: 216-201

Ferrule; Sleeve for 0.5 mm² / 20 AWG; insulated; electro-tin plated; white



Item No.: 216-141

Ferrule; Sleeve for 0.5 mm² / 20 AWG; un-insulated; electro-tin plated; electrolytic copper; gastight crimped; acc. to DIN 46228, Part 1/08.92



Item No.: 216-101

Ferrule; Sleeve for 0.5 mm² / AWG 22; un-insulated; electro-tin plated; silver-colored



Item No.: 216-242

Ferrule; Sleeve for 0.75 mm² / 18 AWG; insulated; electro-tin plated; electrolytic copper; gastight crimped; acc. to DIN 46228, Part 4/09.90; gray



Item No.: 216-262

Ferrule; Sleeve for 0.75 mm² / 18 AWG; insulated; electro-tin plated; electrolytic copper; gastight crimped; acc. to DIN 46228, Part 4/09.90; gray



Item No.: 216-202

Ferrule; Sleeve for 0.75 mm² / 18 AWG; insulated; electro-tin plated; gray



Item No.: 216-142

Ferrule; Sleeve for 0.75 mm² / 18 AWG; un-insulated; electro-tin plated; electrolytic copper; gastight crimped; acc. to DIN 46228, Part 1/08.92



Item No.: 216-102

Ferrule; Sleeve for 0.75 mm² / AWG 20; un-insulated; electro-tin plated; silver-colored



Item No.: 216-243

Ferrule; Sleeve for 1 mm² / AWG 18; insulated; electro-tin plated; electrolytic copper; gastight crimped; acc. to DIN 46228, Part 4/09.90; red



Item No.: 216-263

Ferrule; Sleeve for 1 mm² / AWG 18; insulated; electro-tin plated; electrolytic copper; gastight crimped; acc. to DIN 46228, Part 4/09.90; red



Item No.: 216-203

Ferrule; Sleeve for 1 mm² / AWG 18; insulated; electro-tin plated; red



Item No.: 216-103

Ferrule; Sleeve for 1 mm² / AWG 18; un-insulated; electro-tin plated



Item No.: 216-143

Ferrule; Sleeve for 1 mm² / AWG 18; un-insulated; electro-tin plated; electrolytic copper; gastight crimped; acc. to DIN 46228, Part 1/08.92



Item No.: 216-204

Ferrule; Sleeve for 1.5 mm² / AWG 16; insulated; electro-tin plated; black



Item No.: 216-244

Ferrule; Sleeve for 1.5 mm² / AWG 16; insulated; electro-tin plated; electrolytic copper; gastight crimped; acc. to DIN 46228, Part 4/09.90; black



Item No.: 216-264

Ferrule; Sleeve for 1.5 mm² / AWG 16; insulated; electro-tin plated; electrolytic copper; gastight crimped; acc. to DIN 46228, Part 4/09.90; black



Item No.: 216-284

Ferrule; Sleeve for 1.5 mm² / AWG 16; insulated; electro-tin plated; electrolytic copper; gastight crimped; acc. to DIN 46228, Part 4/09.90; black



Item No.: 216-144

Ferrule; Sleeve for 1.5 mm² / AWG 16; un-insulated; electro-tin plated; electrolytic copper; gastight crimped; acc. to DIN 46228, Part 1/08.92; silver-colored



Item No.: 216-104

Ferrule; Sleeve for 1.5 mm² / AWG 16; un-insulated; electro-tin plated; silver-colored



Item No.: 216-106

Ferrule; Sleeve for 2.5 mm² / AWG 14; un-insulated; electro-tin plated; silver-colored

1.2.3 Installation

1.2.3.1 Mounting accessories



Item No.: 209-137

Mounting adapter; can be used as end stop; 6.5 mm wide; gray

1.2.4 Insulation stop

1.2.4.1 Insulation stop



Item No.: 231-670

Insulation stop; 0.08-0.2 mm² / 0.2 mm² "s"; white



Item No.: 231-671

Insulation stop; 0.25 - 0.5 mm²; light gray



Item No.: 231-672

Insulation stop; 0.75 - 1 mm²; dark gray

1.2.5 Jumper

1.2.5.1 Jumper



Item No.: 231-902

Jumper; for conductor entry; 2-way; insulated; gray



Item No.: 231-903

Jumper; for conductor entry; 3-way; insulated; gray



Item No.: 231-905

Jumper; for conductor entry; 5-way; insulated; gray



Item No.: 231-907

Jumper; for conductor entry; 7-way; insulated; gray

1.2.6 Marking

1.2.6.1 Marking strip



Item No.: 210-331/500-103

Marking strips; as a DIN A4 sheet; MARKED; 1-12 (300x); Height of marker strip: 2.3 mm/0.091 in; Strip length 182 mm; Horizontal marking; Self-adhesive; white



Item No.: 210-332/500-202

Marking strips; as a DIN A4 sheet; MARKED; 1-16 (160x); Height of marker strip: 3 mm; Strip length 182 mm; Horizontal marking; Self-adhesive; white



Item No.: 210-332/500-205

Marking strips; as a DIN A4 sheet; MARKED; 1-32 (80x); Height of marker strip: 3 mm; Strip length 182 mm; Horizontal marking; Self-adhesive; white



Item No.: 210-331/500-104

Marking strips; as a DIN A4 sheet; MARKED; 13-24 (300x); Height of marker strip: 2.3 mm/0.091 in; Strip length 182 mm; Horizontal marking; Self-adhesive; white



Item No.: 210-332/500-204

Marking strips; as a DIN A4 sheet; MARKED; 17-32 (160x); Height of marker strip: 3 mm; Strip length 182 mm; Horizontal marking; Self-adhesive; white



Item No.: 210-332/500-206

Marking strips; as a DIN A4 sheet; MARKED; 33-48 (160x); Height of marker strip: 3 mm; Strip length 182 mm; Horizontal marking; Self-adhesive; white

1.2.7 Mounting adapter

1.2.7.1 Mounting accessories



Item No.: 209-148

Multi mounting adapter; for female and male connectors; 25 mm wide; 3 parts; gray

1.2.8 Strain relief

1.2.8.1 Strain relief housing



Item No.: 232-608

Strain relief housing; for female and male connectors; 2 parts; Pin spacing 5 mm; 8-pole; gray

1.2.9 Test and measurement

1.2.9.1 Testing accessories



Item No.: 210-136

Test plug; 2 mm Ø; with 500 mm cable; red



Item No.: 231-661

Test plugs for female connectors; for 5 mm and 5.08 mm pin spacing; 2,50 mm²; light gray

1.2.10 Tool

1.2.10.1 Operating tool



Item No.: 231-231

Combination operating tool; red



Item No.: 209-132

Operating tool; for connecting comb-style jumper bar; made of insulating material; 2-way; natural



Item No.: 209-130

Operating tool; made of insulating material; 1-way; for 264 Series (1-/2-way), 280, 281 Series (up to 3-way); natural



Item No.: 231-291

Operating tool; made of insulating material; 1-way; loose; red



Item No.: 231-131

Operating tool; made of insulating material; 1-way; loose; white



Item No.: 280-432

Operating tool; made of insulating material; 2-way; white



Item No.: 280-433

Operating tool; made of insulating material; 3-way; white



Item No.: 280-434

Operating tool; made of insulating material; 4-way; white



Item No.: 280-435

Operating tool; made of insulating material; 5-way; gray



Item No.: 280-436

Operating tool; made of insulating material; 6-way; white



Item No.: 280-437

Operating tool; made of insulating material; 7-way; white



Item No.: 280-438

Operating tool; made of insulating material; 8-way; white



Item No.: 231-159

Operating tool; natural

Installation Notes

Conductor termination

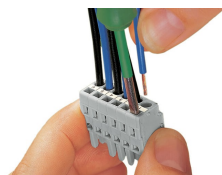

Inserting a conductor via 3.5 mm screwdriver – CAGE CLAMP® actuation parallel to conductor entry.

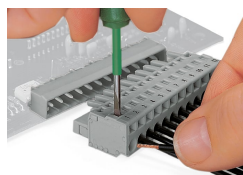

Inserting a conductor via 3.5 mm screwdriver – CAGE CLAMP® actuation perpendicular to conductor entry.



Inserting a conductor into CAGE CLAMP® unit via operating tool (231-291).

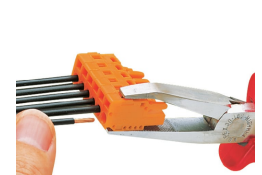

Inserting a conductor via operating tool.

Coding



Coding a female connector by removing coding finger(s).

Testing

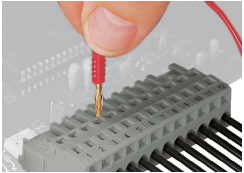

Testing – female connector with CAGE CLAMP®
Integrated test ports for testing perpendicular to conductor entry via 2 or 2.3 mm Ø test plug

Installation

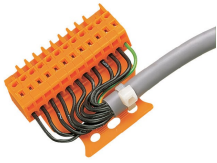

Male connector with strain relief plate



Strain relief housing shown with a male connector equipped with CAGE CLAMP®

Marking

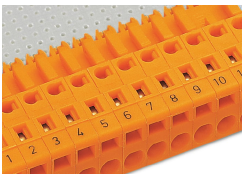

Labeling via direct marking or self-adhesive strips.