



FASTON | FASTON 250

TE Internal #: 2238205-3

Quick Disconnects, Receptacle, 22 – 16 AWG Wire Size, .4 – 1.3 mm² Wire Size, 700 – 2600 CMA Wire Size, Mating Tab Width .25 in [6.35 mm], FASTON 250

[View on TE.com >](#)

Terminals & Splices > Quick Disconnects



Quick Disconnect Terminal Type: **Receptacle**

Wire Size: **700 – 2600 CMA**

Mating Tab Width: **6.35 mm [.25 in]**

Features

Product Type Features

Terminates To	Wire & Cable
Wire Stop	No
Wire/Cable Type	Regular Wire
Insertion Force	Low
Sealable	No

Configuration Features

Connection Capacity	Single
---------------------	--------

Electrical Characteristics

Voltage (Max)	600 V
---------------	-------

Contact Features

Quick Disconnect Terminal Type	Receptacle
Mating Tab Width	6.35 mm [.25 in]
Mating Tab Thickness	.81 mm [.032 in]
Terminal Orientation	Flag
Contact Base Material	Brass



Terminal Plating Material	Tin
Crimp Type	Tab-Lok
Barrel Type	Open

Mechanical Attachment

Mating Retention Type	Dimple
Wire Insulation Support	With

Dimensions

Accepts Wire Insulation Diameter Range	2.79 – 5.33 mm [.11 – .21 in]
Receptacle Terminal Stock Thickness	.41 mm [.016 in]
Wire Size	700 – 2600 CMA

Usage Conditions

Insulation Option	Uninsulated
Operating Temperature Range	-40 – 125 °C [-40 – 125 °F]

Packaging Features

Packaging Quantity	3500
Packaging Method	Reel/Carton

Other

Line	FASTON .250
------	-------------

Product Compliance

[For compliance documentation, visit the product page on TE.com>](#)

EU RoHS Directive 2011/65/EU	Compliant
EU ELV Directive 2000/53/EC	Compliant
China RoHS 2 Directive MIIT Order No 32, 2016	No Restricted Materials Above Threshold
EU REACH Regulation (EC) No. 1907/2006	Current ECHA Candidate List: JAN 2023 (233) Candidate List Declared Against: JUNE 2022 (224) Does not contain REACH SVHC
Halogen Content	Low Halogen - Br, Cl, F, I < 900 ppm per homogenous material. Also BFR/CFR/PVC Free
Solder Process Capability	Not reviewed for solder process capability

Product Compliance Disclaimer



This information is provided based on reasonable inquiry of our suppliers and represents our current actual knowledge based on the information they provided. This information is subject to change. The part numbers that TE has identified as EU RoHS compliant have a maximum concentration of 0.1% by weight in homogenous materials for lead, hexavalent chromium, mercury, PBB, PBDE, DBP, BBP, DEHP, DIBP, and 0.01% for cadmium, or qualify for an exemption to these limits as defined in the Annexes of Directive 2011/65/EU (RoHS2). Finished electrical and electronic equipment products will be CE marked as required by Directive 2011/65/EU. Components may not be CE marked. Additionally, the part numbers that TE has identified as EU ELV compliant have a maximum concentration of 0.1% by weight in homogenous materials for lead, hexavalent chromium, and mercury, and 0.01% for cadmium, or qualify for an exemption to these limits as defined in the Annexes of Directive 2000/53/EC (ELV). Regarding the REACH Regulation, the information TE provides on SVHC in articles for this part number is based on the latest European Chemicals Agency (ECHA) 'Guidance on requirements for substances in articles' posted at this URL: <https://echa.europa.eu/guidance-documents/guidance-on-reach>

Compatible Parts



TE Part # 42475-4
250 FASTON TAB 22-18 AWG TPBR



TE Part # 567372-2
HINGE BAR HDM 9EMPO140T1400 T



TE Part # 42475-5
FASTON 250 TERMINAL TAB 22-18 AWG TPBR

Also in the Series | FASTON 250



Compression Connectors(4)



Crimp Terminal Housings(139)



Insertion & Extraction Tools(6)



Magnet Wire Terminals(1)



PCB Terminals(135)

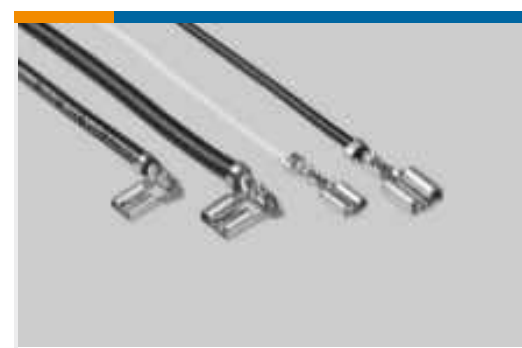

Quick Disconnects(444)



Splices(4)

Customers Also Bought



TE Part #DT04-2P
REC, 2P, GRY, N



TE Part #W2S
DEUTSCH DT Wedgelocks

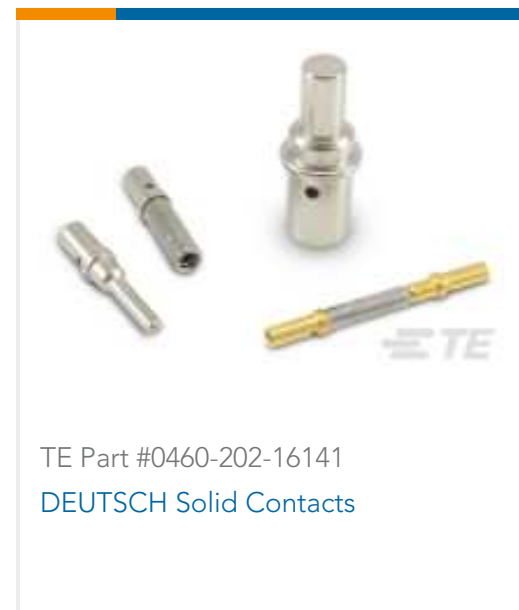

TE Part #0460-202-16141
DEUTSCH Solid Contacts



TE Part #282104-1
AMP SUPERSEAL 1.5MM,
CONNECTOR HOUSING

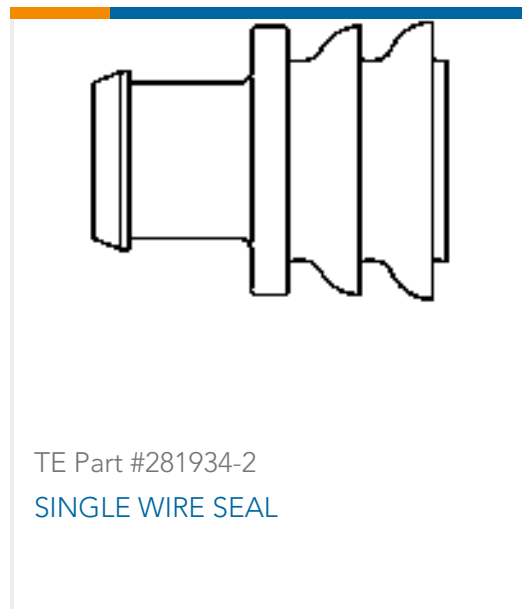

TE Part #281934-2
SINGLE WIRE SEAL



TE Part #114017-ZZ
SEALING PLUG, SIZE 12/16, WHT



TE Part #DT06-2S
PLG, 2P, GRY, N

Documents

Product Drawings

[250 FASTON, FLAG, REC., 22-16 AWG, PTBR](#)

English

CAD Files

[3D PDF](#)

3D

Customer View Model

[ENG_CVM_CVM_2238205-3_A.2d_dxf.zip](#)

English

Customer View Model

[ENG_CVM_CVM_2238205-3_A.3d_igs.zip](#)

English

Customer View Model

[ENG_CVM_CVM_2238205-3_A.3d_stp.zip](#)

English

By downloading the CAD file I accept and agree to the [Terms and Conditions](#) of use.

Product Specifications

[Application Specification](#)

English