

2229800-1 ✓ ACTIVE

[Dynamic Series](#) | [Dynamic 3000 Series](#)

TE Internal #: 2229800-1

Receptacle, Wire-to-Board, 6 Position, 7.5 mm [.295 in] Centerline, 2 Row, 180° Wire Entry Angle, Dynamic 3000 Series, PCB Terminal Blocks

[View on TE.com >](#)



Connectors > Terminal Blocks & Strips > PCB Terminal Blocks



Terminal Block Connector Type: **Receptacle**

Connector System: **Wire-to-Board**

Number of Positions: **6**

Centerline (Pitch): **7.5 mm [.295 in]**

Number of Rows: **2**

Features

Product Type Features

Terminal Block Connector Type	Receptacle
Connector System	Wire-to-Board
Connector & Contact Terminates To	Wire & Cable

Configuration Features

Wire Entry Location	Top
Number of Positions	6
Number of Rows	2
Wire Entry Angle	180°

Electrical Characteristics

Operating Voltage	300 VAC
-------------------	---------

Body Features

Primary Product Color	Black
Product Orientation	Vertical



Contact Features

Contact Mating Area Plating Material	Gold
Contact Base Material	Copper Alloy
Contact Current Rating (Max)	12.7 A

Termination Features

Termination Method to Wire & Cable	Push-in
------------------------------------	---------

Mechanical Attachment

Connector Mounting Type	Cable Mount (Free-Hanging)
-------------------------	----------------------------

Housing Features

Housing Material	Thermoplastic
Centerline (Pitch)	7.5 mm [.295 in]

Dimensions

Wire Size	.32 – 2.1 mm ²
-----------	---------------------------

Usage Conditions

Operating Temperature Range	-30 – 105 °C [-22 – 221 °F]
-----------------------------	-----------------------------

Operation/Application

Circuit Application	Power & Signal
---------------------	----------------

Packaging Features

Packaging Method	Tray
------------------	------

Product Compliance

[For compliance documentation, visit the product page on TE.com>](#)

EU RoHS Directive 2011/65/EU	Compliant
EU ELV Directive 2000/53/EC	Compliant
China RoHS 2 Directive MIIT Order No 32, 2016	No Restricted Materials Above Threshold
EU REACH Regulation (EC) No. 1907/2006	Current ECHA Candidate List: JUNE 2024 (241) Candidate List Declared Against: JUNE 2024 (241) Does not contain REACH SVHC
Halogen Content	Not Low Halogen - contains Br or Cl > 900 ppm.
Solder Process Capability	Not reviewed for solder process capability

Product Compliance Disclaimer

This information is provided based on reasonable inquiry of our suppliers and represents our current actual knowledge based on the information they provided. This information is subject to change. The part numbers that TE has identified as EU RoHS compliant have a maximum concentration of 0.1% by weight in homogenous materials for lead, hexavalent chromium, mercury, PBB, PBDE, DBP, BBP, DEHP, DIBP, and 0.01% for cadmium, or qualify for an exemption to these limits as defined in the Annexes of Directive 2011/65/EU (RoHS2). Finished electrical and electronic equipment products will be CE marked as required by Directive 2011/65/EU. Components may not be CE marked. Additionally, the part numbers that TE has identified as EU ELV compliant have a maximum concentration of 0.1% by weight in homogenous materials for lead, hexavalent chromium, and mercury, and 0.01% for cadmium, or qualify for an exemption to these limits as defined in the Annexes of Directive 2000/53/EC (ELV). Regarding the REACH Regulation, the information TE provides on SVHC in articles for this part number is based on the latest European Chemicals Agency (ECHA) 'Guidance on requirements for substances in articles' posted at this URL: <https://echa.europa.eu/guidance-documents/guidance-on-reach>

Compatible Parts



Also in the Series | Dynamic 3000 Series

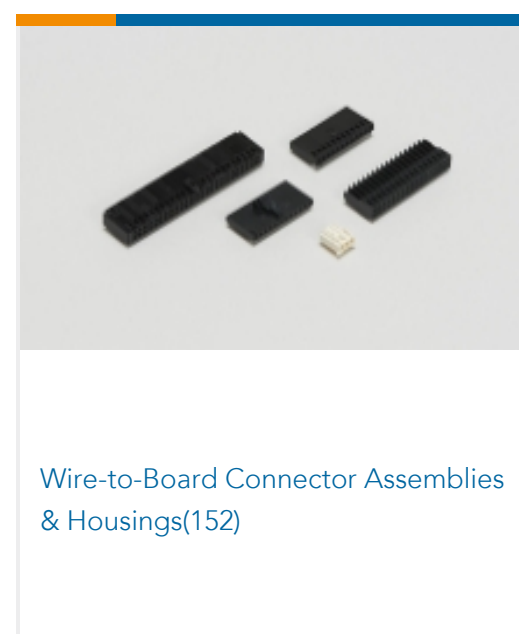
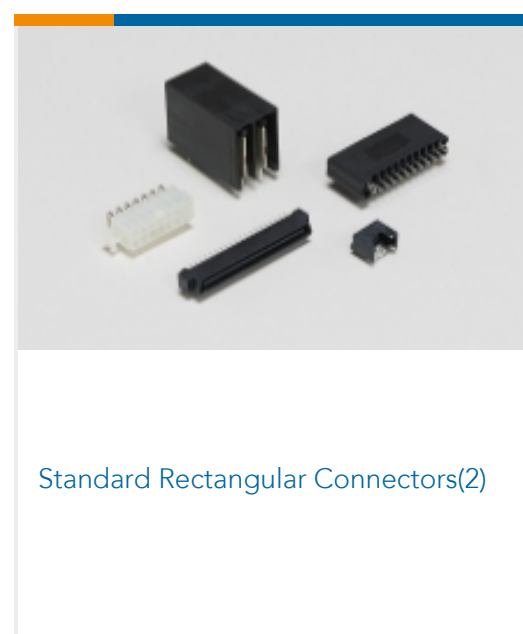
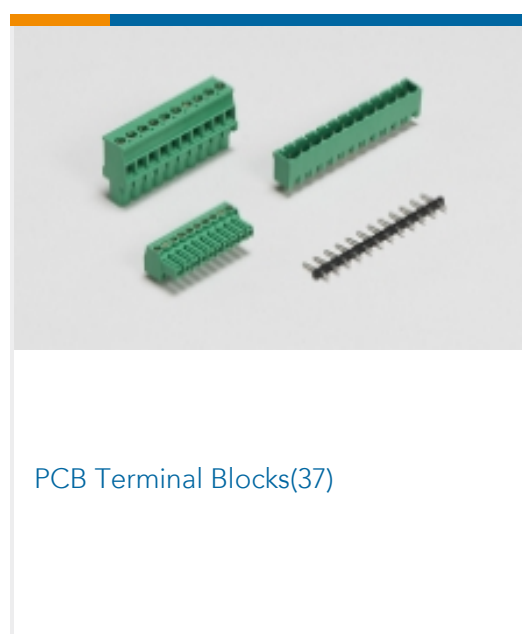
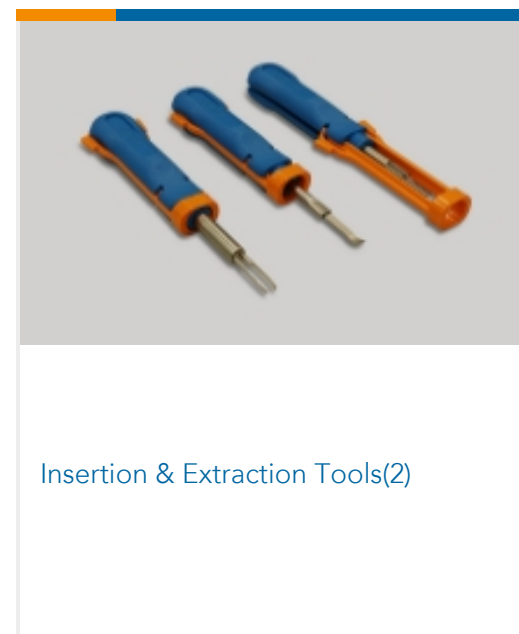
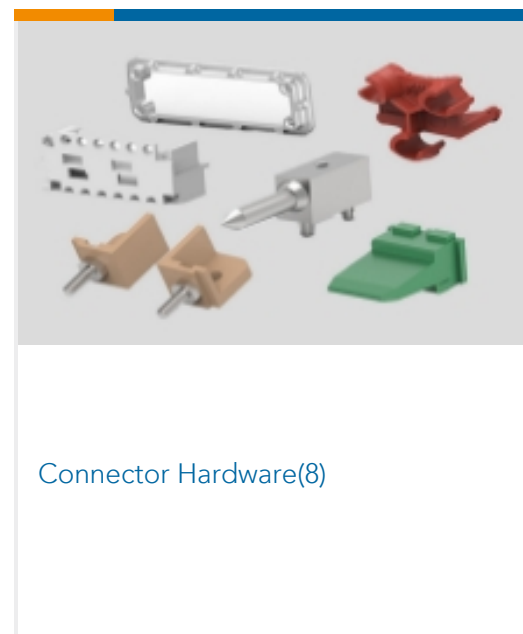
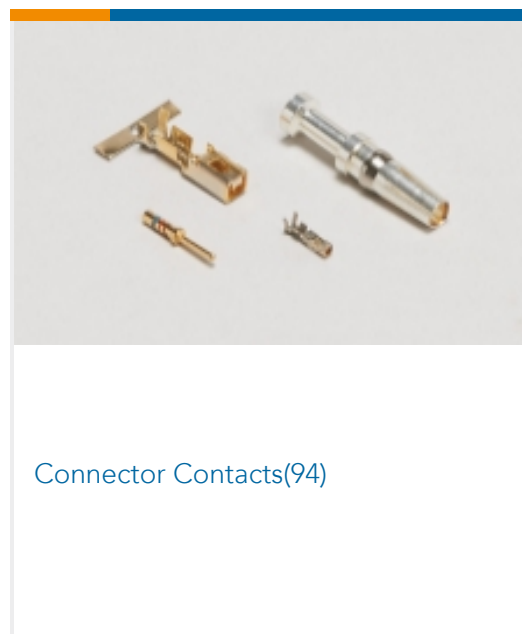

Customers Also Bought



TE Part #1-178136-2
DYNAMIC D3200 HDR V ASSY 3P



TE Part #3-2229803-1
Header Assembly: Wire-to-Board
Connector, Spring Clamp, 7.5 mm
pitch, 14.5A



TE Part #292304-1
STD USB TYPE B, R/A, T/H



TE Part #350779-1
04P UMNL PLUG HSG



TE Part #1-2229794-1
D3950 REC 11POS 1ROW X KEY
MARKED

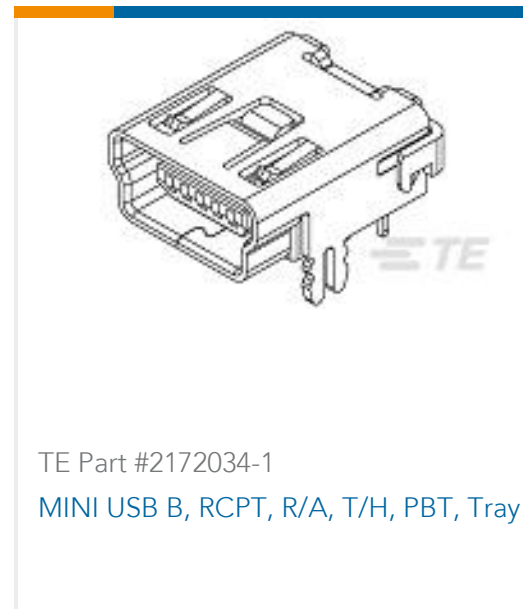

TE Part #2172034-1
MINI USB B, RCPT, R/A, T/H, PBT, Tray



TE Part #2294415-1
INDUSTRIAL MINI I/O HDR TYPE I
TRAY



TE Part #3-5175475-8
CHAMP 050 B/B REC V W/LEG 68P
TRAY



TE Part #1-2289080-2
D3950 REC 11POS 1ROW X KEY WB

Documents

Product Drawings

[D3950 REC 6POS 2ROW MARKED](#)

Japanese

CAD Files

[3D PDF](#)

3D

Customer View Model

[ENG_CVM_CVM_2229800-1_C.2d_dxf.zip](#)

English

Customer View Model

[ENG_CVM_CVM_2229800-1_C.3d_igs.zip](#)

English

Customer View Model

[ENG_CVM_CVM_2229800-1_C.3d_stp.zip](#)

English

By downloading the CAD file I accept and agree to the [Terms and Conditions](#) of use.

Datasheets & Catalog Pages



DYNAMIC SPRING CLAMP SERIES

English

DYNAMIC SPRING CLAMP SERIES

Japanese

Introducing TE's D3950 Series Connector

English

Product Specifications

Product Specification

English

Instruction Sheets

Instruction Sheet (non U.S.)

English

Agency Approvals

UL Report

English