

Data Sheet | Item Number: 216-109

Ferrule; Sleeve for 10 mm² / AWG 8; uninsulated; electro-tin plated

<https://www.wago.com/216-109>

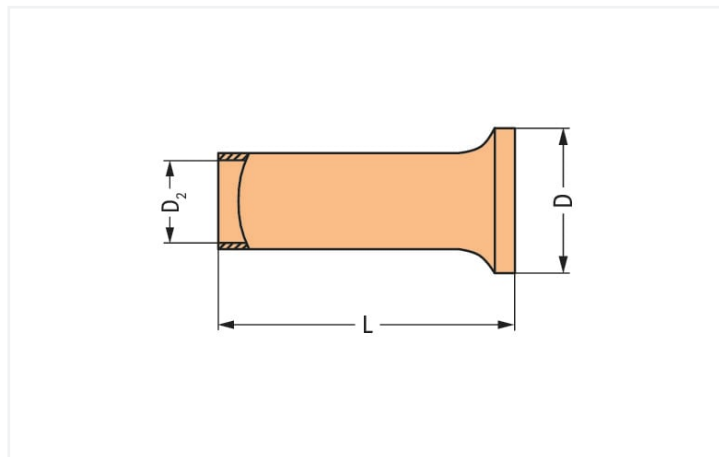

Dimensions in mm

Technical data

Sleeve cross-section (AWG)	8 AWG
Sleeve for	10 mm ²

Connection data

Strip length	12 mm / 0.47 inches
--------------	---------------------

Physical data

Length	12 mm
Diameter	5.8 mm
Diameter crimp sleeve inside	4.5 mm

Material data

Fire load	0 MJ
Weight	0.3 g

Commercial data

Product Group	2 (Terminal Block Accessories)
eCl@ss 10.0	27-40-02-01
eCl@ss 9.0	27-40-02-01
ETIM 9.0	EC000005
ETIM 8.0	EC000005
PU (SPU)	1000 (250) pcs
Packaging type	Box
Country of origin	DE
GTIN	4017332277716
Customs tariff number	85369010000

Environmental Product Compliance

RoHS Compliance Status	Compliant, No Exemption
------------------------	-------------------------

Downloads

Environmental Product Compliance

Compliance Search	
Environmental Product Compliance 216-109	↓

Documentation

Bid Text			
216-109	11.09.2017	doc 24.00 KB	↓
216-109	19.02.2019	xml 2.77 KB	↓

Installation Notes

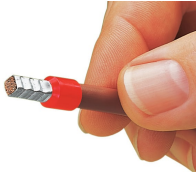

A perfect gas-tight crimp – both electrical-ly and mechanically reliable