

## Data Sheet | Item Number: 216-102

Ferrule; Sleeve for 0.75 mm<sup>2</sup> / AWG 20; uninsulated; electro-tin plated; silver-colored

<https://www.wago.com/216-102>



Color: ■ silver-colored

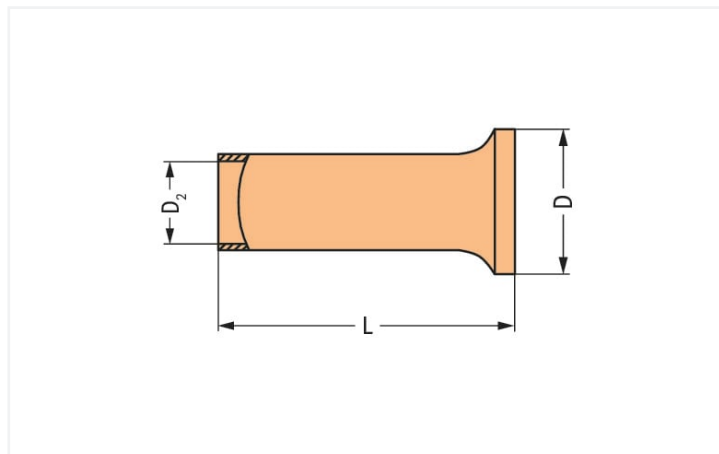

Dimensions in mm

### Technical data

Sleeve cross-section (AWG)	18 AWG
Sleeve for	0.75 mm <sup>2</sup>

### Connection data

Strip length	8 mm / 0.31 inches
--------------	--------------------

### Physical data

Length	8 mm
Diameter	2.3 mm
Diameter crimp sleeve inside	1.2 mm

### Material data

Color	silver-colored
Fire load	0 MJ
Weight	0 g

### Commercial data

Product Group	2 (Terminal Block Accessories)
eCl@ss 10.0	27-40-02-01
eCl@ss 9.0	27-40-02-01
ETIM 9.0	EC000005
ETIM 8.0	EC000005
PU (SPU)	5000 (1000) pcs
Packaging type	Box
Country of origin	DE
GTIN	4017332277631
Customs tariff number	85369010000

### Environmental Product Compliance

RoHS Compliance Status	Compliant, No Exemption
------------------------	-------------------------

### Downloads

#### Environmental Product Compliance

Compliance Search	
Environmental Product Compliance 216-102	<a href="#">↓</a>

### Documentation

Bid Text			
216-102	11.09.2017	doc 24.00 KB	<a href="#">↓</a>
216-102	19.02.2019	xml 2.77 KB	<a href="#">↓</a>

### Installation Notes

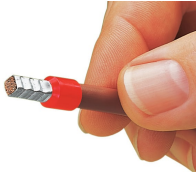

A perfect gas-tight crimp – both electrical-ly and mechanically reliable