



Connectors > Power Connectors > Circular Power > Circular Power Connectors



Connector Product Type: **Housing**

Operating Voltage: **600 VDC**

Connector System: **Wire-to-Wire**

Number of Positions: **7**

Sealable: **No**

Features

Product Type Features

Connector Product Type	Housing
Connector System	Wire-to-Wire
Sealable	No
Connector & Contact Terminates To	Wire & Cable
Connector & Housing Type	Receptacle
Circular Connector Shell Type	All Plastic

Configuration Features

Reverse Numbering	Without
Number of Positions	7
Number of Power Positions	0
Keying	A
Number of Signal Positions	7

Electrical Characteristics

Operating Voltage	600 VAC
-------------------	---------

Contact Features

Reverse Gender	No
Contact Type	Pin
Contact Protection	With



Mechanical Attachment

Panel Mount Feature Type	Flange with Threaded Inserts
Screw & Hole Thread Size	3/4 - 20 UNEF-2A
Connector Mounting Type	Panel Mount
Mating Alignment	With
Mating Retention	With
Panel Mount Feature	With
Mating Alignment Type	Keyed
Mating Retention Type	Threaded Coupling

Housing Features

Body Orientation	Straight
Housing Color	Black
Housing Material	Thermoplastic
Circular Connector Shell Size	13

Usage Conditions

Operating Temperature Range	-55 – 105 °C[-67 – 221 °F]
Fluid Resistance	None

Operation/Application

Circuit Application	Power & Signal
Shielded	No

Industry Standards

UL Flammability Rating	UL 94V-0
VDE Tested	Yes

Packaging Features

Packaging Method	Package
Packaging Quantity	1

Product Compliance

[For compliance documentation, visit the product page on TE.com>](#)

EU RoHS Directive 2011/65/EU	Not Yet Reviewed
EU ELV Directive 2000/53/EC	Compliant
China RoHS 2 Directive MIIT Order No 32, 2016	No Restricted Materials Above Threshold



EU REACH Regulation (EC) No. 1907/2006

Current ECHA Candidate List: JUN 2020 (209)

Candidate List Declared Against: JUN 2016 (169)

Does not contain REACH SVHC

Halogen Content

Not Yet Reviewed for halogen content

Solder Process Capability

Wave solder capable to 265°C

Product Compliance Disclaimer

This information is provided based on reasonable inquiry of our suppliers and represents our current actual knowledge based on the information they provided. This information is subject to change. The part numbers that TE has identified as EU RoHS compliant have a maximum concentration of 0.1% by weight in homogenous materials for lead, hexavalent chromium, mercury, PBB, PBDE, DBP, BBP, DEHP, DIBP, and 0.01% for cadmium, or qualify for an exemption to these limits as defined in the Annexes of Directive 2011/65/EU (RoHS2). Finished electrical and electronic equipment products will be CE marked as required by Directive 2011/65/EU. Components may not be CE marked. Additionally, the part numbers that TE has identified as EU ELV compliant have a maximum concentration of 0.1% by weight in homogenous materials for lead, hexavalent chromium, and mercury, and 0.01% for cadmium, or qualify for an exemption to these limits as defined in the Annexes of Directive 2000/53/EC (ELV). Regarding the REACH Regulations, TE's information on SVHC in articles for this part number is still based on the European Chemical Agency (ECHA) 'Guidance on requirements for substances in articles' (Version: 2, April 2011), applying the 0.1% weight on weight concentration threshold at the finished product level. TE is aware of the European Court of Justice ruling of September 10th, 2015 also known as O5A (Once An Article Always An Article) stating that, in case of 'complex object', the threshold for a SVHC must be applied to both the product as a whole and simultaneously to each of the articles forming part of its composition. TE has evaluated this ruling based on the new ECHA "Guidance on requirements for substances in articles" (June 2017, version 4.0) and will be updating its statements accordingly.

Compatible Parts



TE Model / Part # CAT-AM71-C83998K
CPC SERIES 6

Also in the Series | AMP CPC



Circular Connector Adapters(7)



Circular Connector Boots & Strain Relief(6)



Circular Connector Caps & Covers(16)



Circular Connector Hardware(3)



Circular Connector Keying Plugs(2)



Circular Connector Seals(35)



Circular Power Connectors(513)

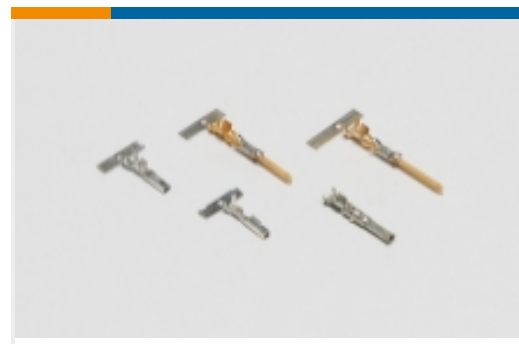

Power Contacts(5)

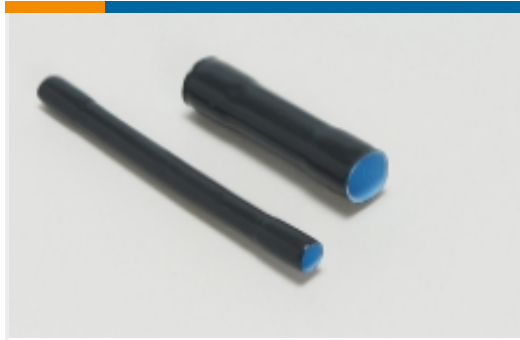

Sealing & Repair Sleeves(2)



Unscreened Circular Connector Backshells & Clamps(56)

Customers Also Bought



TE Model / Part #1676275-2
RN 0805 280R 0.1% 10PPM 1KRL

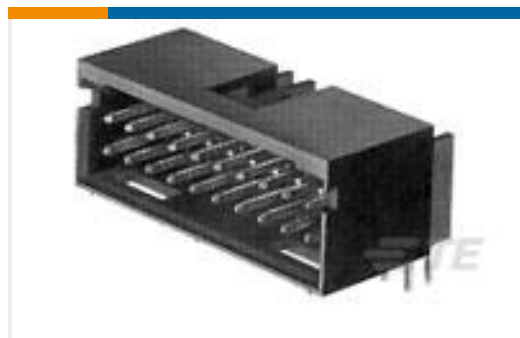

TE Model / Part #7-103166-3
50 MODII HDR DRRA SHRD LF



TE Model / Part #5413558-2
JACK,RTANG,PCB,75 OHM BNC



TE Model / Part #1-1614422-0
RN 0805 178K 0.1% 10PPM 1K RL

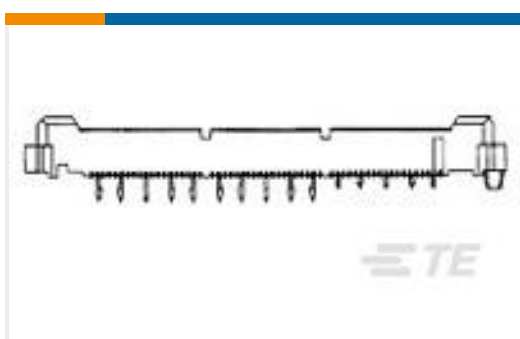

TE Model / Part #5767054-5
MICT,RECPT,190,ASSY,PDNI

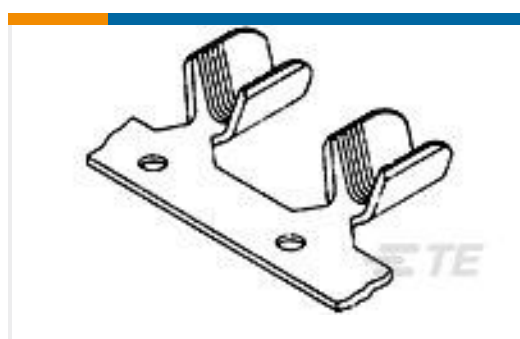

TE Model / Part #63621-2
SPLICE S-MINI/AMVAR 0098TPCUBR



TE Model / Part #5745996-4
37 MSFL RCPT RA 590 (IN,FM)



TE Model / Part #1934339-1
TinMan Header Assy 3x10 Open

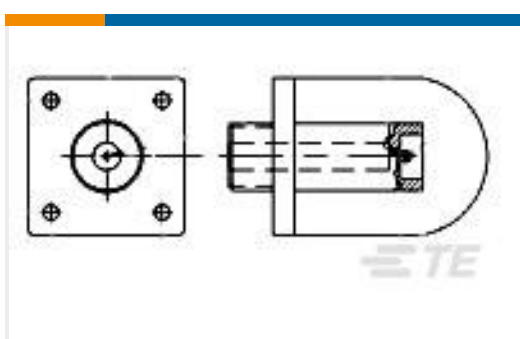

TE Model / Part #5-850911-1
LGH-3 BULKHEAD RECEPT.

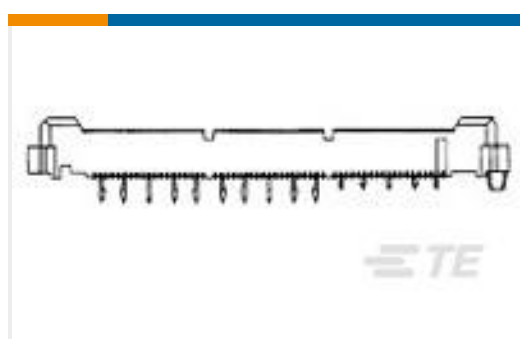

TE Model / Part #767054-5
MICT,RECPT,190,ASSY,PDNI

Documents



Product Drawings

[RECEPT,SZ 13-7,CPC](#)

English

CAD Files

[3D PDF](#)

3D

Customer View Model

[ENG_CVM_CVM_211401-5_AC.2d_dxf.zip](#)

English

Customer View Model

[ENG_CVM_CVM_211401-5_AC.3d_igs.zip](#)

English

Customer View Model

[ENG_CVM_CVM_211401-5_AC.3d_stp.zip](#)

English

By downloading the CAD file I accept and agree to the [Terms and Conditions](#) of use.

Product Specifications

[Application Specification](#)

English

Instruction Sheets

[Instruction Sheet \(U.S.\)](#)

English

[Instruction Sheet \(U.S.\)](#)

English