

Data Sheet | Item Number: 2091-1122

1-conductor female connector; push-button; Push-in CAGE CLAMP®; 1.5 mm²; Pin spacing 3.5 mm; 2-pole; 1,50 mm²; light gray

<https://www.wago.com/2091-1122>



Color: ■ light gray

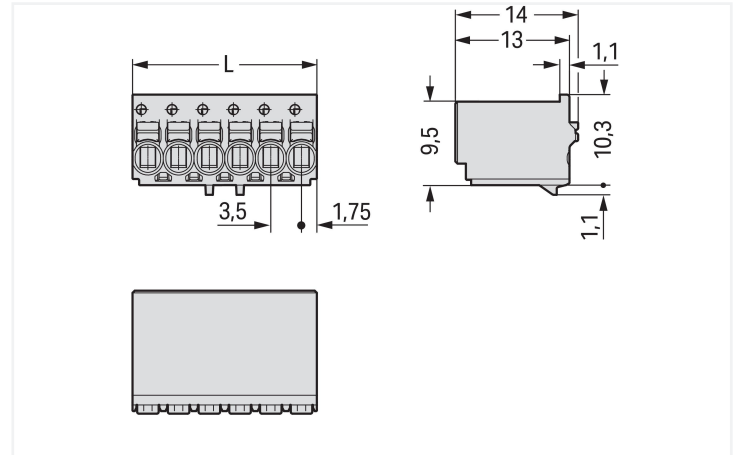

Dimensions in mm

L = pole no. x pin spacing

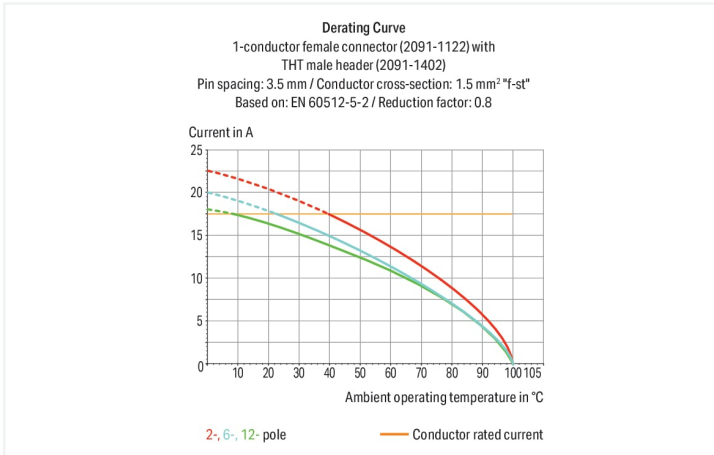

- Universal connection of all conductor types
- Simple, push-in termination of solid and ferruled conductors
- Easy-to-use design does not require special tools
- Ability to wire while mated or unmated
- Testing parallel to conductor entry – tip contact
- Also available with gripping plates
- Integrated locking latches prevent accidental disconnection

Notes

Safety Information

The **picoMAX® Pluggable Connection System** includes connectors without breaking capacity in accordance with DIN EN 61984. When used as intended, these connectors must not be connected/disconnected when live or under load. The circuit design should ensure header pins, which can be touched, are not live when unmated.

Safety information 2

The use of ferrules is recommended for applications with higher requirements.

Variants:

Effective cable securing must be used to prevent undue force on the clamping unit.

Direct marking
Other versions (or variants) can be requested from WAGO Sales or configured at <https://configurator.wago.com/>.

Electrical data

Ratings per	IEC/EN 60664-1			Approvals per	UL 1059		
Overvoltage category	III	III	II	Use group	B	C	D
Pollution degree	3	2	2	Rated voltage	300 V	-	300 V
Nominal voltage	160 V	160 V	320 V	Rated current	10 A	-	10 A
Rated surge voltage	2.5 kV	2.5 kV	2.5 kV				
Rated current	10 A	10 A	10 A				

Connection data

Clamping units	2	Connection 1	
Total number of potentials	2	Connection technology	Push-in CAGE CLAMP®
Number of connection types	1	Actuation type	Push-button
Number of levels	1	Actuation direction 1	Operation parallel to conductor entry
		Solid conductor	0.2 ... 1.5 mm ² / 24 ... 14 AWG
		Fine-stranded conductor	0.2 ... 1.5 mm ² / 24 ... 14 AWG
		Fine-stranded conductor; with insulated ferrule	0.25 ... 0.75 mm ²
		Fine-stranded conductor; with uninsulated ferrule	0.25 ... 1.5 mm ²
		Strip length	8 ... 9 mm / 0.31 ... 0.35 inches
		Pole number	2

Physical data

Pin spacing	3.5 mm / 0.138 inches
Width	7 mm / 0.276 inches
Height	14 mm / 0.551 inches
Depth	11.4 mm / 0.449 inches

Mechanical data

Variable coding	Yes
Anti-rotation protection	Yes

Plug-in connection

Contact type (pluggable connector)	Female connector/socket
Connector (connection type)	for conductor
Mismating protection	No
Plugging without loss of pin spacing	Yes

Material data

Note (material data)	Information on material specifications can be found here
Color	light gray
Material group	I
Insulation material (main housing)	Polyphthalamide (PPA GF)
Flammability class per UL94	V0
Clamping spring material	Chrome-nickel spring steel (CrNi)
Contact material	Electrolytic copper (E _{Cu})
Contact Plating	Tin
Fire load	0.021 MJ
Weight	0.9 g

Environmental requirements

Limit temperature range	-60 ... +100 °C
Processing temperature	-35 ... +60 °C

Commercial data

Product Group	26 (picoMAX Connectors)
eCl@ss 10.0	27-14-11-06
eCl@ss 9.0	27-14-11-06
ETIM 9.0	EC001284
ETIM 8.0	EC001284
PU (SPU)	200 pcs
Packaging type	Box
Country of origin	DE
GTIN	4050821160755
Customs tariff number	85366990990

Environmental Product Compliance

RoHS Compliance Status	Compliant, No Exemption
------------------------	-------------------------

Approvals / Certificates

General approvals



Approval	Standard	Certificate Name
CB DEKRA Certification B.V.	IEC 61984	NL-49736/A1
CSA DEKRA Certification B.V.	C22.2	2362521
CSA DEKRA Certification B.V.	C22.2 No. 158	2362521
KEMA/KEUR DEKRA Certification B.V.	EN 61984	71-102260 REV.1
UL Underwriters Laboratories Inc.	UL 1977	E45171
UR Underwriters Laboratories Inc.	UL 1059	E45172

Downloads

Environmental Product Compliance

Compliance Search

Environmental Product
Compliance 2091-1122



Documentation

Additional Information

Technical Section	03.04.2019	pdf 2027.26 KB	
-------------------	------------	-------------------	--

CAD/CAE-Data

CAD data	CAE data
2D/3D Models 2091-1122	ZUKEN Portal 2091-1122

1 Compatible Products

1.1 System counterpart

1.1.1 Male connector/plug



Item No.: 2091-1522/020-000
1-conductor male connector; Push-in CAGE CLAMP®; 1.5 mm²; Pin spacing 3.5 mm; 2-pole; DIN-35 rail/panel mounting; Snap-in mounting feet; Integrated release lever; 1,50 mm²; light gray



Item No.: 2091-1502/002-000
1-conductor male connector; Push-in CAGE CLAMP®; 1.5 mm²; Pin spacing 3.5 mm; 2-pole; Gripping plate; 1,50 mm²; light gray



Item No.: 2091-1522/002-000
1-conductor male connector; Push-in CAGE CLAMP®; 1.5 mm²; Pin spacing 3.5 mm; 2-pole; Integrated release lever; 1,50 mm²; light gray



Item No.: 2091-1632/024-000
Panel feedthrough male connector; clamping collar; 1.5 mm²; 2-pole; Pin spacing 3.5 mm; light gray



Item No.: 2091-1422/205-000
THR male header; 1.0 mm Ø solder pin; angled; clamping collar; Pin spacing 3.5 mm; 2-pole; light gray



Item No.: 2091-1422/200-000/997-405
THR male header; 1.0 mm Ø solder pin; angled; in tape-and-reel packaging; Pin spacing 3.5 mm; 2-pole; light gray



Item No.: 2091-1422/200-604
THR male header; 1.0 mm Ø solder pin; angled; Pin spacing 3.5 mm; 2-pole; black



Item No.: 2091-1422/200-000
THR male header; 1.0 mm Ø solder pin; angled; Pin spacing 3.5 mm; 2-pole; light gray



Item No.: 2091-1402/205-000
THR male header; 1.0 mm Ø solder pin; straight; clamping collar; Pin spacing 3.5 mm; 2-pole; light gray



Item No.: 2091-1402/200-000
THR male header; 1.0 mm Ø solder pin; straight; Pin spacing 3.5 mm; 2-pole; light gray



Item No.: 2091-1722/200-000
THR pin strip; 1.0 mm Ø solder pin; angled; Pin spacing 3.5 mm; 2-pole; black



Item No.: 2091-1702/200-000
THR pin strip; 1.0 mm Ø solder pin; straight; Pin spacing 3.5 mm; 2-pole; black



Item No.: 2091-1422/005-000
THT male header; 1.0 mm Ø solder pin; angled; clamping collar; Pin spacing 3.5 mm; 2-pole; light gray



Item No.: 2091-1422
THT male header; 1.0 mm Ø solder pin; angled; Pin spacing 3.5 mm; 2-pole; light gray



Item No.: 2091-1402/005-000
THT male header; 1.0 mm Ø solder pin; straight; clamping collar; Pin spacing 3.5 mm; 2-pole; light gray



Item No.: 2091-1402
THT male header; 1.0 mm Ø solder pin; straight; Pin spacing 3.5 mm; 2-pole; light gray



Item No.: 2091-1722
THT pin strip; 1.0 mm Ø solder pin; angled; Pin spacing 3.5 mm; 2-pole; black



Item No.: 2091-1702
THT pin strip; 1.0 mm Ø solder pin; straight; Pin spacing 3.5 mm; 2-pole; black

1.2 Optional Accessories

1.2.1 Coding

1.2.1.1 Coding



Item No.: 2091-1610

Coding key carrier; suitable for 3.5 mm pin spacing; orange

1.2.2 Ferrule

1.2.2.1 Ferrule



Item No.: 216-301

Ferrule; Sleeve for 0.25 mm² / AWG 24; insulated; electro-tin plated; yellow



Item No.: 216-131

Ferrule; Sleeve for 0.25 mm² / AWG 24; uninsulated; electro-tin plated; silver-colored



Item No.: 216-302

Ferrule; Sleeve for 0.34 mm² / 22 AWG; insulated; electro-tin plated; light turquoise



Item No.: 216-132

Ferrule; Sleeve for 0.34 mm² / AWG 24; uninsulated; electro-tin plated



Item No.: 216-101

Ferrule; Sleeve for 0.5 mm² / AWG 22; uninsulated; electro-tin plated; silver-colored



Item No.: 216-202

Ferrule; Sleeve for 0.75 mm² / 18 AWG; insulated; electro-tin plated; gray



Item No.: 216-102

Ferrule; Sleeve for 0.75 mm² / AWG 20; uninsulated; electro-tin plated; silver-colored



Item No.: 216-122

Ferrule; Sleeve for 0.75 mm² / AWG 20; uninsulated; electro-tin plated; silver-colored



Item No.: 216-203

Ferrule; Sleeve for 1 mm² / AWG 18; insulated; electro-tin plated; red



Item No.: 216-103

Ferrule; Sleeve for 1 mm² / AWG 18; uninsulated; electro-tin plated



Item No.: 216-143

Ferrule; Sleeve for 1 mm² / AWG 18; uninsulated; electro-tin plated; electrolytic copper; gastight crimped; acc. to DIN 46228, Part 1/08.92



Item No.: 216-204

Ferrule; Sleeve for 1.5 mm² / AWG 16; insulated; electro-tin plated; black



Item No.: 216-144

Ferrule; Sleeve for 1.5 mm² / AWG 16; uninsulated; electro-tin plated; electrolytic copper; gastight crimped; acc. to DIN 46228, Part 1/08.92; silver-colored



Item No.: 216-104

Ferrule; Sleeve for 1.5 mm² / AWG 16; uninsulated; electro-tin plated; silver-colored



Item No.: 216-106

Ferrule; Sleeve for 2.5 mm² / AWG 14; uninsulated; electro-tin plated; silver-colored

1.2.3 Strain relief

1.2.3.1 Gripping plate



Item No.: 2091-1600/002-000

Gripping plate with sliding connector release; for female and male connectors; 2 parts; Pin spacing 3.5 mm; 2-pole; light gray



Item No.: 2091-1600

Gripping plate; for female and male connectors; 1 part; Pin spacing 3.5 mm; 2-pole; light gray

1.2.4 Test and measurement

1.2.4.1 Testing accessories



Item No.: 735-500

WAGO Test pin; 1 mm Ø; 30 V AC / 60 V DC; CAT0; 1 A; 6 mm uninsulated; Test lead for soldering up to 0,5mm²

1.2.5 Tool

1.2.5.1 Operating tool



Item No.: 210-719

Operating tool; Blade: 2.5 x 0.4 mm; with a partially insulated shaft



Item No.: 2092-1630

Unlocking tool; orange

Installation Notes

Locking system

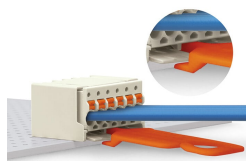

Disconnecting a female connector via unlocking tool. Plug unlocking tool into the male header's locking latch.

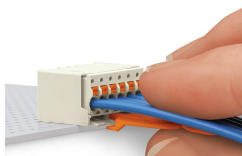

Insert unlocking tool until it hits the back-stop. Wedge opens locking latches.

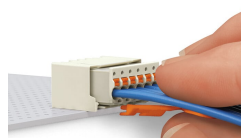

Pull on both unlocking tool and conductors to remove female connector from male header.

Conductor termination

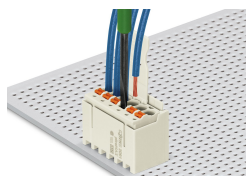

Inserting fine-stranded conductor into mated female connector via push-button.



Inserting a fine-stranded conductor into an unmated female connector via push-button.

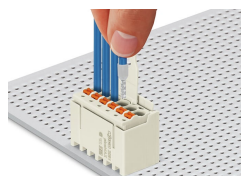

Inserting solid and ferruled conductors via push-in termination.

Marking



Pole marking via factory direct marking.

Coding

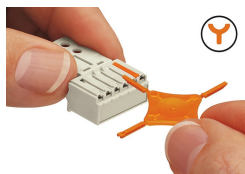

Coding a female connector (via coding key carrier and two keys for female connector, see symbol).

Testing



Testing via 1 mm Ø test pin – touch contact.