

Data Sheet | Item Number: 2070-542/998-406

Through-Board SMD PCB Terminal Block; 0.75 mm²; Pin spacing 6.5 mm; 2-pole; Push-in CAGE CLAMP®; in tape-and-reel packaging; 0,75 mm²; white

<https://www.wago.com/2070-542/998-406>



Color: ■ white

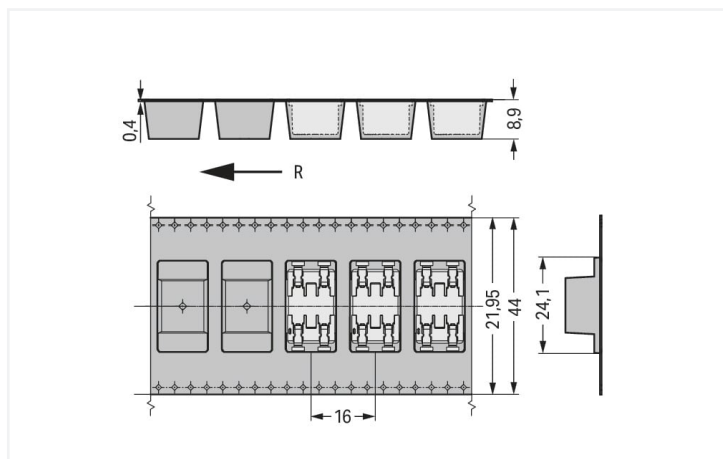

Dimensions in mm
R = feed direction

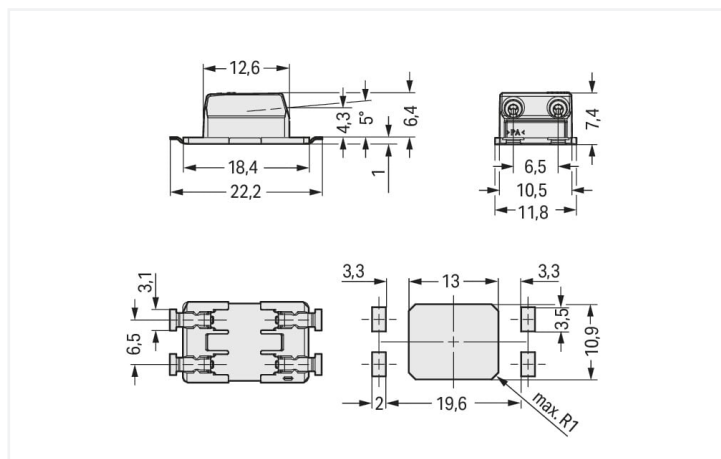

Dimensions in mm

- SMD PCB terminal block with Push-in CAGE CLAMP® for back-side wiring of LED modules
- Low profile of just 1.1 mm on the module's front side
- Push-in termination of solid conductors
- Insert fine-stranded conductors and remove all conductors via operating tool

Notes

Note

Depending on reflow soldering temperatures and times, color deviations may occur. These deviations will have no impact on functionality.

Variants:

Reel diameter of tape-and-reel packaging: 381 mm
Other versions (or variants) can be requested from WAGO Sales or configured at <https://configurator.wago.com/>.

Electrical data

Ratings	Electrical data for FR4 PCB type		
	IEC/EN 60664-1	IEC/EN 60664-1	IEC/EN 60664-1
Ratings per			
Overvoltage category	III	III	II
Pollution degree	3	2	2
Nominal voltage	320 V	320 V	630 V
Rated surge voltage	4 kV	4 kV	4 kV
Rated current	9 A	9 A	9 A

Ratings	Electrical data for metal-core PCBs		
	IEC/EN 60664-1	IEC/EN 60664-1	IEC/EN 60664-1
Ratings per			
Overvoltage category	III	III	II
Pollution degree	3	2	2
Nominal voltage	200 V	320 V	500 V
Rated surge voltage	4 kV	4 kV	4 kV

Ratings	Electrical data for metal-core PCBs		
Rated current	9 A	9 A	9 A

Ratings	
Approvals per	UL 1977
Rated voltage	600 V
Rated current	9 A

Connection data

Clamping units	2
Total number of potentials	2
Number of connection types	1
Number of levels	1

Connection 1	
Connection technology	Push-in CAGE CLAMP®
Actuation type	Operating tool
Solid conductor	0.2 ... 0.75 mm ² / 24 ... 18 AWG
Fine-stranded conductor	0.2 ... 0.75 mm ² / 24 ... 18 AWG
Strip length	8 ... 10 mm / 0.31 ... 0.39 inches
Conductor connection direction to PCB	0°
Pole number	2

Physical data

Pin spacing	6.5 mm / 0.256 inches
Width	11.8 mm / 0.465 inches
Height	7.45 mm / 0.293 inches
Depth	22.2 mm / 0.874 inches
Reel diameter of tape-and-reel packaging	330 mm
Tape width	44 mm
PCB thickness (max.)	2.4 mm

Mechanical data

Marking	- +
Design	with cover
Mounting type	Through-board

PCB contact

PCB contact	SMD
Solder pin arrangement	over the entire terminal strip (in-line)
Number of solder pins per potential	2

Material data

Note (material data)	Information on material specifications can be found here
Color	white
Material group	I
Insulation material (main housing)	Polyphthalamide (PPA GF)
Flammability class per UL94	V0
Contact material	Copper alloy
Contact Plating	Tin
Fire load	0.025 MJ
Weight	1.3 g

Environmental requirements

Limit temperature range -60 ... +105 °C

Environmental Testing (Environmental Conditions)

Test specification Railway applications – Rolling stock – Electronic equipment	DIN EN 50155 (VDE 0115-200):2022-06
Test procedure Railway applications – Rolling stock equipment – Shock and vibration tests	DIN EN 61373 (VDE 0115-0106):2011-04
Spectrum/Installation location	Service life test, Category 1, Class A/B
Function test with noise-like vibration	Test passed according to Section 8 of the standard
Frequency	$f_1 = 5 \text{ Hz}$ to $f_2 = 150 \text{ Hz}$ $f_1 = 5 \text{ Hz}$ to $f_2 = 150 \text{ Hz}$
Acceleration	0.101g (highest test level used for all axes) 0.572g (highest test level used for all axes) 5g (highest test level used for all axes)
Test duration per axis	10 min. 5 h
Test directions	X, Y and Z axes X, Y and Z axes X, Y and Z axes
Monitoring for contact faults/interruptions	Passed
Voltage drop measurement before and after each axis	Passed
Simulated service life test through increased levels of noise-like vibration	Test passed according to Section 9 of the standard
Extended test scope: Monitoring for contact faults/interruptions	Passed Passed
Extended test scope: Voltage drop measurement before and after each axis	Passed Passed
Shock test	Test passed according to Section 10 of the standard
Shock form	Half sine
Shock duration	30 ms
Number of shocks per axis	3 pos. und 3 neg.
Vibration and shock stress for rolling stock equipment	Passed

Commercial data

eCl@ss 10.0	27-14-11-06
eCl@ss 9.0	27-14-11-06
ETIM 9.0	EC001284
ETIM 8.0	EC001284
PU (SPU)	2385 (477) pcs
Packaging type	Box
Country of origin	CH
GTIN	4055143645119
Customs tariff number	85369010000

Environmental Product Compliance	
RoHS Compliance Status	Compliant, No Exemption

Approvals / Certificates

General approvals			Declarations of conformity and manufacturer's declarations		
Approval	Standard	Certificate Name	Approval	Standard	Certificate Name
CB DEKRA Certification B.V.	IEC 60998	NL-57652	EU-Declaration of Confor- mity WAGO GmbH & Co. KG	-	-
CB DEKRA Certification B.V.	EN 60998	NL-57653	Railway WAGO GmbH & Co. KG	-	Z00004398.000
KEMA/KEUR DEKRA Certification B.V.	EN 60998	71-107967	UK-Declaration of Confor- mity WAGO GmbH & Co. KG	-	-
KEMA/KEUR DEKRA Certification B.V.	EN 60947-7-4	71-107965			
UR Underwriters Laboratories Inc.	UL 1977	E45171			

Downloads

Environmental Product Compliance	
Compliance Search	
Environmental Product Compliance 2070-542/998-406	↓

Documentation

Additional Information			
Technical Section	03.04.2019	pdf 2027.26 KB	↓

CAD/CAE-Data

CAD data	CAE data
2D/3D Models 2070-542/998-406	ZUKEN Portal 2070-542/998-406
↓	↓

PCB Design

Symbol and Footprint via SamacSys 2070-542/998-406	↓
Symbol and Footprint via Ultra Librarian 2070-542/998-406	↓

1 Compatible Products

1.1 Optional Accessories

1.1.1 Tool

1.1.1.1 Operating tool



Item No.: 2070-400

Operating tool; made of insulating material; green

Installation Notes

Conductor termination

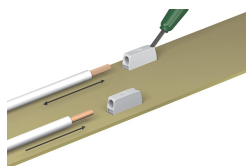

Insert fine-stranded conductors and remove all conductor types via operating tool. Solid conductors can also be terminated by simply pushing them in.

Conductor removal

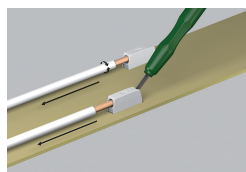

Use an operating tool or simply "twist and pull" to remove solid conductors.

Installation

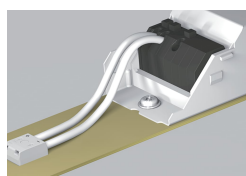

Shift wiring to the back of the LED module via 2070 Series SMD PCB Terminal Blocks.

Application

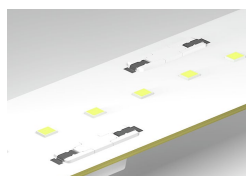

The variants with cover feature a center contact surface for easy pick-and-place assembly and minimum shadowing.

Application

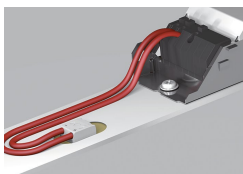

The printed variants offer unique pole marking on the back of the module.