

PLEASE CHECK WWW.MOLEX.COM FOR LATEST PART INFORMATION

Part Number: [2035552312](#)
Status: **Active**
Overview: CP Wire-to-Board and Wire-to-Wire Connector Systems
Description: CP-6.5 Header, 6.50mm Pitch, Dual Row, Right-Angle, Polarized, Surface Mount, Tube Packaging, 2 Circuits, Natural

Documents:

[Drawing \(PDF\)](#) [Test Summary 2035550001-TS-000 \(PDF\)](#)
[Product Specification 2035550001-PS-000 \(PDF\)](#) [RoHS Certificate of Compliance \(PDF\)](#)

Agency Certification

UL E29179

General

Product Family PCB Headers
 Series [203555](#)
 Application Power, Wire-to-Board
 CURRENT-MAX-NUMERIC 10.0
 Comments See Product Specification for maximum current rating by circuit size and wire AWG, See Product Specification for maximum current rating by circuit size and wire AWG
 Datasheet Order No 987651-1601
 Overview [CP Wire-to-Board and Wire-to-Wire Connector Systems](#)
 PITCH-MATING-NUMERIC 6.50
 Product Name CP-6.5
 UPC 191130538683

Physical

Breakaway No
 Circuits (Loaded) 2
 Circuits (maximum) 2
 Color - Resin Natural
 Durability (mating cycles max) 30
 First Mate / Last Break No
 Flammability 94V-0
 Glow-Wire Capable No
 Guide to Mating Part No
 Keying to Mating Part Yes
 Lock to Mating Part Yes
 Material - Metal Copper Alloy
 Material - Plating Mating Matte Tin
 Material - Plating Termination Matte Tin
 Material - Resin Nylon
 Number of Rows 2
 Orientation Right Angle
 PCB Locator Yes
 PCB Retention Yes
 Packaging Type Tube
 Pitch - Mating Interface 6.50mm
 Pitch - Termination Interface 6.50mm
 Plating min - Mating 1.270µm
 Plating min - Termination 1.270µm
 Polarized to Mating Part Yes
 Polarized to PCB Yes
 Temperature Range - Operating -40° to +105°C
 Termination Interface: Style Surface Mount

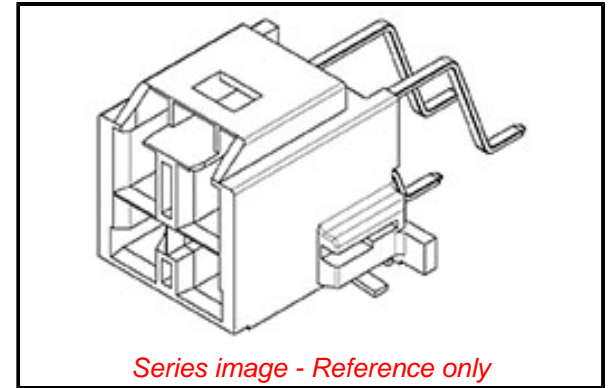

Series image - Reference only

EU ELV

Not Reviewed

EU RoHS

Not Reviewed

REACH SVHC

Not Reviewed

Halogen-Free

Status

Not Reviewed

For more information, please visit [Contact US](#)

China ROHS

Not Reviewed

ELV

Not Reviewed

RoHS Phthalates

Not Reviewed

Search Parts in this Series

[203555 Series](#)

Mates With

CP-6.5 Receptacle Housing [1512072211](#)

Electrical

Current - Maximum per Contact

10.0A

Voltage - Maximum

600V AC (RMS)/DC

Material Info**Reference - Drawing Numbers**

Product Specification

2035550001-PS-000

Sales Drawing

2035552000-SD-000

Test Summary

2035550001-TS-000

This document was generated on 06/07/2019

PLEASE CHECK WWW.MOLEX.COM FOR LATEST PART INFORMATION