

## Data Sheet | Item Number: 2002-880

Empty component plug housing; 10.4 mm wide; 2-pole; Type 4; gray

<https://www.wago.com/2002-880>

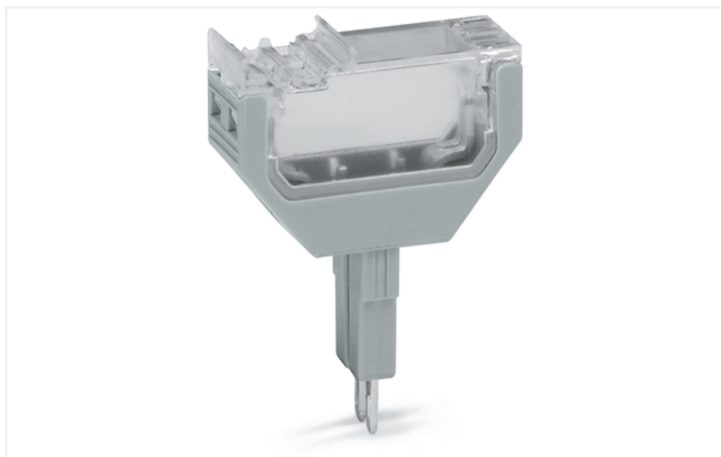

Color: ■ gray

### Physical data

Width	10.4 mm / 0.409 inches
-------	------------------------

### Mechanical data

Marking level	Center marking
---------------	----------------

### Material data

Note (material data)

[Information on material specifications can be found here](#)

Color	gray
Material group	I
Insulation material (main housing)	Polyamide (PA66)
Flammability class per UL94	V0
Fire load	0.127 MJ
Weight	4 g

### Environmental requirements

Processing temperature	-35 ... +85 °C
Continuous operating temperature	-60 ... +105 °C

### Commercial data

Product Group	22 (TOPJOB S)
eCl@ss 10.0	27-14-11-49
eCl@ss 9.0	27-18-27-02
ETIM 9.0	EC002018
ETIM 8.0	EC002018
PU (SPU)	50 pcs
Packaging type	Box
Country of origin	DE
GTIN	4045454857790
Customs tariff number	85366990990

**Environmental Product Compliance**

RoHS Compliance Status Compliant, No Exemption

**Downloads**

**Environmental Product Compliance**

**Compliance Search**

Environmental Product Compliance 2002-880 [↓](#)

**Documentation**

**Additional Information**

Technical Section pdf  
2246.92 KB [↓](#)

Bid Text			
2002-880	19.02.2019	xml 2.69 KB	<a href="#">↓</a>
2002-880	02.08.2018	docx 14.23 KB	<a href="#">↓</a>

**CAD/CAE-Data**

**CAD data**

2D/3D Models 2002-880 [↓](#)













CAE data	
WSCAD Universe 2002-880	<a href="#">↓</a>
ZUKEN Portal 2002-880	<a href="#">↓</a>

**1 Compatible Products**

**1.1 Optional Accessories**

**1.1.1 Marking**

**1.1.1.1 Marker**

 <p><b>Item No.: 793-5501/000-006</b> WMB marking card; as card; for terminal block width 5 - 17.5 mm; stretchable 5 - 5.2 mm; plain; snap-on type; blue</p>	 <p><b>Item No.: 793-5501/000-014</b> WMB marking card; as card; for terminal block width 5 - 17.5 mm; stretchable 5 - 5.2 mm; plain; snap-on type; brown</p>	 <p><b>Item No.: 793-5501/000-007</b> WMB marking card; as card; for terminal block width 5 - 17.5 mm; stretchable 5 - 5.2 mm; plain; snap-on type; gray</p>	 <p><b>Item No.: 793-5501/000-023</b> WMB marking card; as card; for terminal block width 5 - 17.5 mm; stretchable 5 - 5.2 mm; plain; snap-on type; green</p>
 <p><b>Item No.: 793-5501/000-017</b> WMB marking card; as card; for terminal block width 5 - 17.5 mm; stretchable 5 - 5.2 mm; plain; snap-on type; light green</p>	 <p><b>Item No.: 793-5501/000-012</b> WMB marking card; as card; for terminal block width 5 - 17.5 mm; stretchable 5 - 5.2 mm; plain; snap-on type; orange</p>	 <p><b>Item No.: 793-5501/000-005</b> WMB marking card; as card; for terminal block width 5 - 17.5 mm; stretchable 5 - 5.2 mm; plain; snap-on type; red</p>	 <p><b>Item No.: 793-5501/000-024</b> WMB marking card; as card; for terminal block width 5 - 17.5 mm; stretchable 5 - 5.2 mm; plain; snap-on type; violet</p>
 <p><b>Item No.: 793-5501</b> WMB marking card; as card; for terminal block width 5 - 17.5 mm; stretchable 5 - 5.2 mm; plain; snap-on type; white</p>	 <p><b>Item No.: 793-5501/000-002</b> WMB marking card; as card; for terminal block width 5 - 17.5 mm; stretchable 5 - 5.2 mm; plain; snap-on type; yellow</p>	 <p><b>Item No.: 2009-115/000-006</b> WMB-Inline; for Smart Printer; 1500 pieces on roll; stretchable 5 - 5.2 mm; plain; snap-on type; blue</p>	 <p><b>Item No.: 2009-115/000-007</b> WMB-Inline; for Smart Printer; 1500 pieces on roll; stretchable 5 - 5.2 mm; plain; snap-on type; gray</p>

1.1.1.1 Marker



**Item No.: 2009-115/000-023**  
WMB-Inline; for Smart Printer; 1500 pieces on roll; stretchable 5 - 5.2 mm; plain; snap-on type; green



**Item No.: 2009-115/000-017**  
WMB-Inline; for Smart Printer; 1500 pieces on roll; stretchable 5 - 5.2 mm; plain; snap-on type; light green



**Item No.: 2009-115/000-012**  
WMB-Inline; for Smart Printer; 1500 pieces on roll; stretchable 5 - 5.2 mm; plain; snap-on type; orange



**Item No.: 2009-115/000-024**  
WMB-Inline; for Smart Printer; 1500 pieces on roll; stretchable 5 - 5.2 mm; plain; snap-on type; violet



**Item No.: 2009-115**  
WMB-Inline; for Smart Printer; 1500 pieces on roll; stretchable 5 - 5.2 mm; plain; snap-on type; white



**Item No.: 2009-115/000-002**  
WMB-Inline; for Smart Printer; 1500 pieces on roll; stretchable 5 - 5.2 mm; plain; snap-on type; yellow

1.1.1.2 Marking strip



**Item No.: 2009-110**  
Marking strips; for Smart Printer; on reel; not stretchable; plain; snap-on type; white

1.1.2 Screwless end stop

1.1.2.1 Mounting accessories



**Item No.: 249-117**  
Screwless end stop; 10 mm wide; for DIN-rail 35 x 15 and 35 x 7.5; gray



**Item No.: 249-116**  
Screwless end stop; 6 mm wide; for DIN-rail 35 x 15 and 35 x 7.5; gray

1.1.3 Terminal blocks

1.1.3.1 Through terminal block



**Item No.: 2002-1201**  
2-conductor through terminal block; 2.5 mm<sup>2</sup>; suitable for Ex e II applications; side and center marking; for DIN-rail 35 x 15 and 35 x 7.5; Push-in CAGE CLAMP®; 2,50 mm<sup>2</sup>; gray



**Item No.: 2202-1201**  
2-conductor through terminal block; with push-button; 2.5 mm<sup>2</sup>; with test port; suitable for Ex e II applications; side and center marking; for DIN-rail 35 x 15 and 35 x 7.5; Push-in CAGE CLAMP®; 2,50 mm<sup>2</sup>; gray



**Item No.: 2002-1301**  
3-conductor through terminal block; 2.5 mm<sup>2</sup>; suitable for Ex e II applications; side and center marking; for DIN-rail 35 x 15 and 35 x 7.5; Push-in CAGE CLAMP®; 2,50 mm<sup>2</sup>; gray



**Item No.: 2202-1301**  
3-conductor through terminal block; with push-button; 2.5 mm<sup>2</sup>; with test port; side and center marking; for DIN-rail 35 x 15 and 35 x 7.5; Push-in CAGE CLAMP®; 2,50 mm<sup>2</sup>; gray



**Item No.: 2002-1401**  
4-conductor through terminal block; 2.5 mm<sup>2</sup>; suitable for Ex e II applications; side and center marking; for DIN-rail 35 x 15 and 35 x 7.5; Push-in CAGE CLAMP®; 2,50 mm<sup>2</sup>; gray



**Item No.: 2202-1401**  
4-conductor through terminal block; with push-button; 2.5 mm<sup>2</sup>; with test port; side and center marking; for DIN-rail 35 x 15 and 35 x 7.5; Push-in CAGE CLAMP®; 2,50 mm<sup>2</sup>; gray

## Installation Notes

### Installation

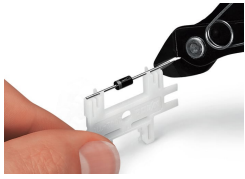

Cutting component to the proper length.

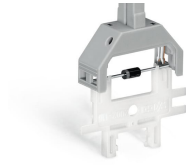

Pressing component into plug contact via operating tool

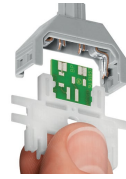

Pushing PCB into plug contact via operating tool.



When closing the cover, please insert cover as shown in the illustration!



Opening the cover via operating tool (2.5 mm blade).



Opening cover via multi-purpose operating tool for component plugs.

### Installation

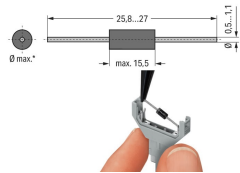

\*max. 3.4 mm  $\varnothing$  at 5.2 mm module width and  
 \*max. 5.4 mm  $\varnothing$  at 10.4 mm module width  
 Notice: Reconnection only possible with similar or larger wire diameter



Component plugs for building custom circuits  
 Solder-free assembly of diodes, resistors, etc.  
 (Illustration shows a 1N4007 diode)

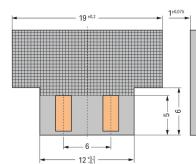

Dimensions of self-assembled PCBs:  
 Module height: 2 mm at 5.2 mm module width and module height: 3.3 mm at 10.4 mm module width