

2-640445-3 ✓ ACTIVE



MTA 156

TE Internal #: 2-640445-3

Header, Plug, Wire-to-Board, 23 Position, 3.96 mm [.156 in]
Centerline, Printed Circuit Board, UL 94V-0, MTA 156, Rectangular
Power Connectors

[View on TE.com >](#)

Connectors > Power Connectors > Rectangular Power > Rectangular Power Connectors

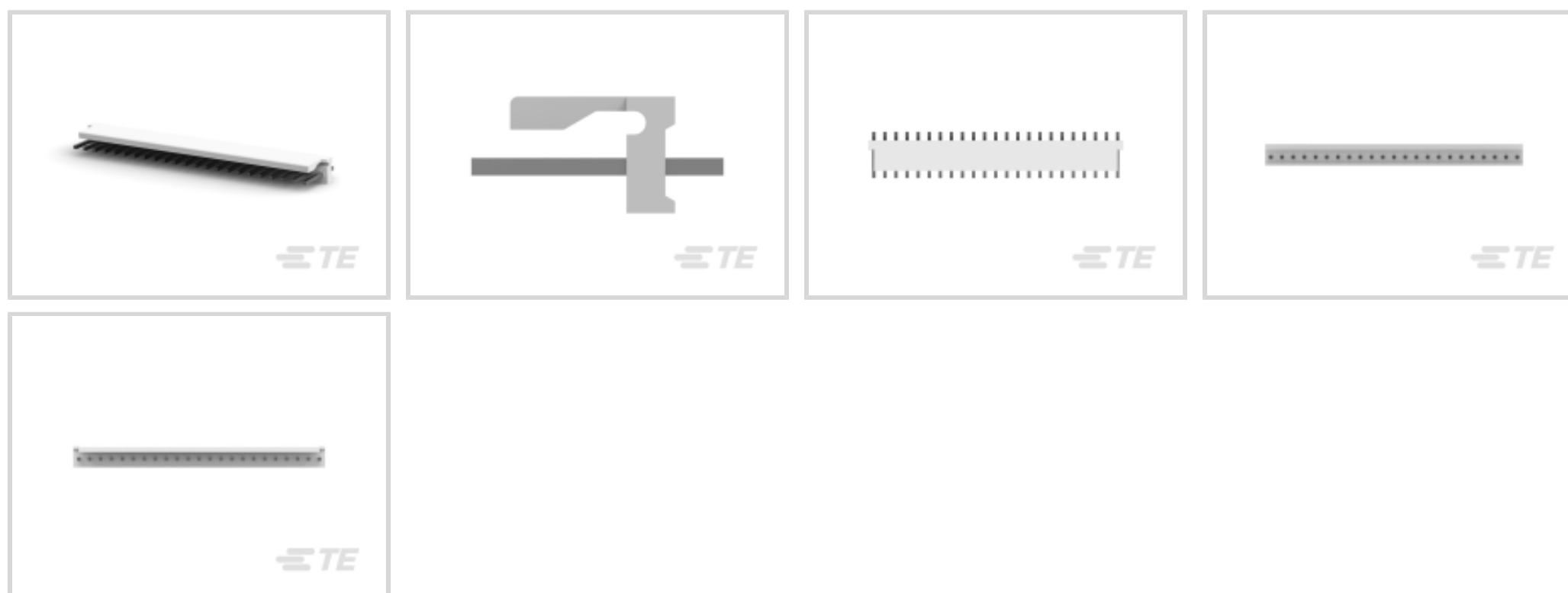

Rectangular Power Connector Type: **Header**

Connector & Housing Type: **Plug**

Connector System: **Wire-to-Board**

Number of Positions: **23**

Centerline (Pitch): **3.96 mm [.156 in]**

Features

Product Type Features

Header Type	Partially Shrouded
Rectangular Power Connector Type	Header
Connector & Housing Type	Plug
Connector System	Wire-to-Board
Sealable	No
Connector & Contact Terminates To	Printed Circuit Board

Configuration Features

Number of Positions	23
PCB Mount Orientation	Vertical
Number of Power Positions	23
Number of Rows	1

Electrical Characteristics

Operating Voltage	600 VAC
-------------------	---------

Contact Features



Mating Post Length	10.16 mm[.4 in]
PCB Contact Termination Area Plating Material Thickness	.76 μm [30 μin]
Contact Layout	Inline
Contact Underplating Material Thickness	1.27 μm [50 μin]
Contact Mating Area Plating Material	Tin
Contact Underplating Material	Nickel
Contact Base Material	Copper Alloy
Contact Current Rating (Max)	7 A
Contact Retention Within Housing	Without
Contact Type	Pin
PCB Contact Termination Area Plating Material	Tin
Contact Mating Area Plating Material Thickness	2.54 μm [100 μin]

Termination Features

Termination Post & Tail Length	1.53 mm[.06 in]
Termination Method to PCB	Through Hole - Solder

Mechanical Attachment

Strain Relief	Without
Mating Retention	With
Mating Alignment	Without
PCB Mount Alignment	Without
Panel Mount Feature	Without
PCB Mount Retention	Without
Mating Retention Type	Friction Lock
Connector Mounting Type	Board Mount

Housing Features

Centerline (Pitch)	3.96 mm[.156 in]
Housing Color	Natural
Housing Material	Polyester

Dimensions

Connector Height	10.79 mm[.425 in]
PCB Thickness (Recommended)	1.57 mm[.062 in]
Product Length	91.14 mm[3.588 in]



Compatible Insulation Diameter Range	5 mm[.197 in]
--------------------------------------	---------------

Usage Conditions

Operating Temperature Range	-55 – 105 °C[-67 – 221 °F]
-----------------------------	----------------------------

Operation/Application

Circuit Application	Power
---------------------	-------

Industry Standards

CSA Rating	Certified, LR 7189
------------	--------------------

UL Rating	Recognized
-----------	------------

Compatible With Agency/Standards Products	CSA, UL, VDE
---	--------------

Compatible With Approved Standards Products	UL E28476
---	-----------

UL Flammability Rating	UL 94V-0
------------------------	----------

Glow Wire Rating	Standard Part - Not Glow Wire
------------------	-------------------------------

Packaging Features

Packaging Quantity	250
--------------------	-----

Packaging Method	Package
------------------	---------

Product Compliance

[For compliance documentation, visit the product page on TE.com>](#)

EU RoHS Directive 2011/65/EU	Compliant
------------------------------	-----------

EU ELV Directive 2000/53/EC	Compliant
-----------------------------	-----------

China RoHS 2 Directive MIIT Order No 32, 2016	No Restricted Materials Above Threshold
---	---

EU REACH Regulation (EC) No. 1907/2006	Current ECHA Candidate List: JUNE 2024 (241) Candidate List Declared Against: JUNE 2024 (241) Does not contain REACH SVHC
--	---

Halogen Content	Not Low Halogen - contains Br or Cl > 900 ppm.
-----------------	--

Solder Process Capability	Wave solder capable to 265°C
---------------------------	------------------------------

Product Compliance Disclaimer

This information is provided based on reasonable inquiry of our suppliers and represents our current actual knowledge based on the information they provided. This information is subject to change. The part numbers that TE has identified as EU RoHS compliant have a maximum concentration of 0.1% by weight in homogenous materials for lead, hexavalent chromium, mercury, PBB, PBDE, DBP, BBP, DEHP, DIBP, and 0.01% for cadmium, or qualify for an exemption to these limits as defined in the Annexes of Directive 2011/65/EU (RoHS2). Finished electrical and electronic equipment products will be CE marked as required by Directive 2011/65/EU. Components may not be CE marked. Additionally, the part numbers that TE has identified as EU ELV compliant have a maximum concentration of 0.1% by weight in homogenous



materials for lead, hexavalent chromium, and mercury, and 0.01% for cadmium, or qualify for an exemption to these limits as defined in the Annexes of Directive 2000/53/EC (ELV). Regarding the REACH Regulation, the information TE provides on SVHC in articles for this part number is based on the latest European Chemicals Agency (ECHA) 'Guidance on requirements for substances in articles' posted at this URL: <https://echa.europa.eu/guidance-documents/guidance-on-reach>

Compatible Parts



TE Part # CAT-103156-WBHSM
Receptacle Housing: Wire-to-Board, with Mating Alignment, SL156



TE Part # 2-640251-3
23P SL156 HSG W/O LCK RAMP



TE Part # 2-640551-3
23P MTA156 COVER



TE Part # 2-643067-3
23P MTA156 MOLDED COVER



TE Part # 2-643071-3
23P MTA156 FD-THRU COVER



TE Part # 5-640426-3
23P MTA156 CONN ASSY 18AWG ORA



TE Part # 5-640428-3
23P MTA156 CONN ASSY 22AWG RED



TE Part # 5-643817-3
23P MTA156 CONN ASSY 18AWG LF



TE Part # 5-643819-3
23P MTA156 CONN ASSY 22AWG LF

Also in the Series | MTA 156



Connector Caps & Covers(89)



Connector Contacts(4)



Connector Hardware(2)



Insertion & Extraction Tools(1)

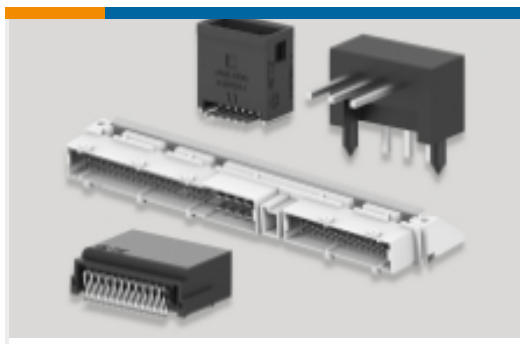

PCB Headers & Receptacles(317)



Rectangular Power Connectors(691)



Standard Rectangular Connectors(336)

Customers Also Bought



TE Part #DT04-2P
REC, 2P, GRY, N



TE Part #DT06-2S
PLG, 2P, GRY, N



TE Part #W2S
Wedgelocks: DEUTSCH DT



TE Part #0460-202-16141
DEUTSCH Solid Contacts



TE Part #282104-1
AMP SUPERSEAL 1.5MM,
CONNECTOR HOUSING

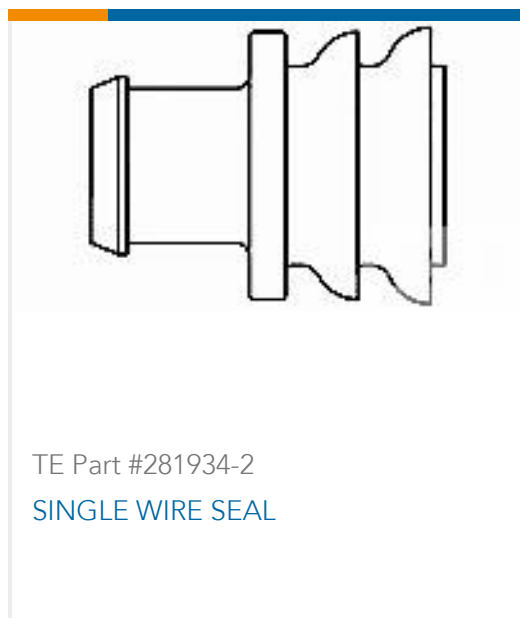

TE Part #281934-2
SINGLE WIRE SEAL



TE Part #114017-ZZ
SEALING PLUG, SIZE 12/16, WHT

Documents

Product Drawings

[23P MTA156 HDR ASSY FL/STR SN](#)

English

CAD Files

Customer View Model

[ENG_CVM_CVM_2-640445-3_AL.2d_dxf.zip](#)

English

[3D PDF](#)

3D

Customer View Model

[ENG_CVM_CVM_2-640445-3_AL.3d_igs.zip](#)

English

Customer View Model

[ENG_CVM_CVM_2-640445-3_AL.3d_stp.zip](#)

English

By downloading the CAD file I accept and agree to the [Terms and Conditions](#) of use.



Product Specifications

[Application Specification](#)

English

Agency Approvals

[Agency Approval Document](#)

English