

2-323916-3 ✓ ACTIVE



PIDG

TE Internal #: 2-323916-3

Closed Ring Tongue Terminal, 24 AWG, M4 Stud Size, 4.34 mm [.171 in] Stud Diameter, Closed Barrel, Straight, Tin, Partially Insulated, PIDG

[View on TE.com >](#)

Terminals & Splices > Ring Terminals > PIDG Ring Tongue Terminals

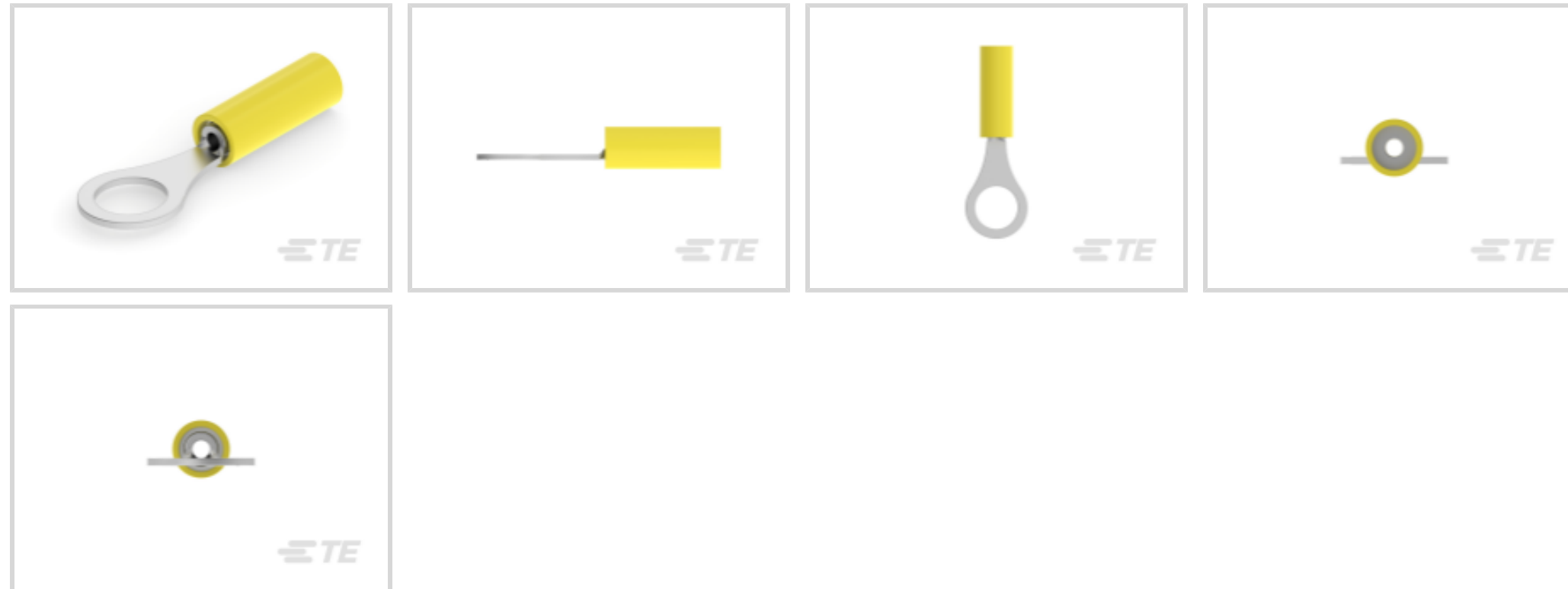

Ring Terminal Product Type: Closed Ring Tongue Terminal

Wire Size: 475 CMA

Stud Size: M4

Stud Diameter: 4.34 mm [.171 in]

[All PIDG Ring Tongue Terminals \(411\)](#)

Features

Product Type Features

Ring Terminal Product Type	Closed Ring Tongue Terminal
Stud Size	M4
Sealable	No
Wire Insulation Support Retention Type	Insulation Restriction

Configuration Features

Number of Holes	1
-----------------	---

Body Features

Stripe Color	Blue
Product Weight	.468 g

Contact Features

Military Part Class	Class II
Barrel Type	Closed
Terminal Orientation	Straight



Terminal Plating Material	Tin
---------------------------	-----

Mechanical Attachment

Wire Insulation Support	With
-------------------------	------

Dimensions

Wire Size	475 CMA
Stud Diameter	4.34 mm [.171 in]
Tongue Thickness	.79 mm [.031 in]
Product Length	18.8 mm [.74 in]
Compatible Insulation Diameter (Max)	1.4 mm [.055 in]
Compatible Insulation Diameter Range	.79 – 1.4 mm [.031 – .055 in]

Usage Conditions

Insulation Option	Partially Insulated
Operating Temperature Range	105 °C [221 °F]

Operation/Application

Compatible With Wire Base Material	Copper
Compatible With Wire Plating Material	Tin

Industry Standards

Government Qualified Terminal	No
-------------------------------	----

Packaging Features

Packaging Quantity	1
Packaging Method	Loose Piece

Product Compliance

[For compliance documentation, visit the product page on TE.com>](#)

EU RoHS Directive 2011/65/EU	Compliant
EU ELV Directive 2000/53/EC	Compliant
China RoHS 2 Directive MIIT Order No 32, 2016	No Restricted Materials Above Threshold
EU REACH Regulation (EC) No. 1907/2006	Current ECHA Candidate List: JUNE 2024 (241) Candidate List Declared Against: JAN 2021 (211) Does not contain REACH SVHC
Halogen Content	BFR/CFR/PVC Free, but Br/Cl >900 ppm in other sources.

Solder Process Capability

Not applicable for solder process capability

Product Compliance Disclaimer

This information is provided based on reasonable inquiry of our suppliers and represents our current actual knowledge based on the information they provided. This information is subject to change. The part numbers that TE has identified as EU RoHS compliant have a maximum concentration of 0.1% by weight in homogenous materials for lead, hexavalent chromium, mercury, PBB, PBDE, DBP, BBP, DEHP, DIBP, and 0.01% for cadmium, or qualify for an exemption to these limits as defined in the Annexes of Directive 2011/65/EU (RoHS2). Finished electrical and electronic equipment products will be CE marked as required by Directive 2011/65/EU. Components may not be CE marked. Additionally, the part numbers that TE has identified as EU ELV compliant have a maximum concentration of 0.1% by weight in homogenous materials for lead, hexavalent chromium, and mercury, and 0.01% for cadmium, or qualify for an exemption to these limits as defined in the Annexes of Directive 2000/53/EC (ELV). Regarding the REACH Regulation, the information TE provides on SVHC in articles for this part number is based on the latest European Chemicals Agency (ECHA) 'Guidance on requirements for substances in articles' posted at this URL: <https://echa.europa.eu/guidance-documents/guidance-on-reach>

Compatible Parts



REPRESENTATION ONLY

TE Part # 46121
DAHT PG PIDG 26-22 ASSY



TE Part # 59170
T-HEAD PIDG SH 26-14 ASSY



TE Part # 59250
T-HEAD PIDG 26-14 ASSY



TE Part # 59275
T-HEAD PIDG PG SH 26-20 ASSY



TE Part # 539691-2
ERGO DIE R.B.Y



TE Part # 47806-2
DIES PIDG 22-16 DIE SET



TE Part # 69344
PIDG 26-22 DIE SET

Also in the Series | PIDG



Compression Connectors(17)



Crimp Wire Pins, Tabs & Ferrules(41)



Hand Crimping Tools(2)

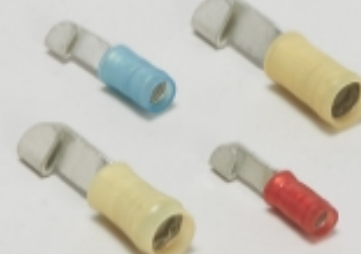

Knife Disconnects(11)

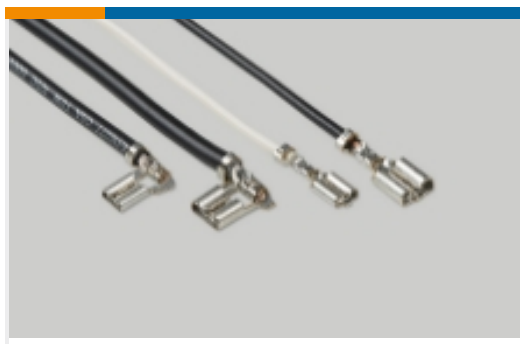

Quick Disconnects(32)



Ring Terminals(589)

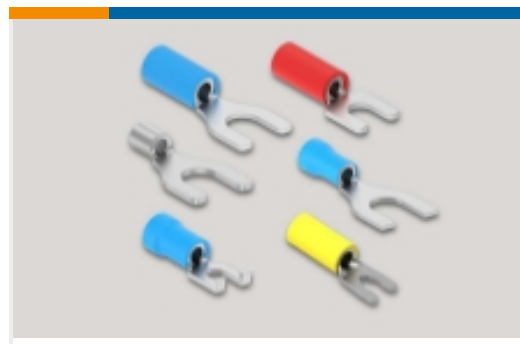

Spade Terminals(228)



Special Purpose Terminals(1)



Splices(40)

Customers Also Bought



TE Part #1658659-1
KIT,HDP-20,ENCLSUR,PLUG,SIZE 3



TE Part #1375820-2
CST-100 II HOUSING 2 POS

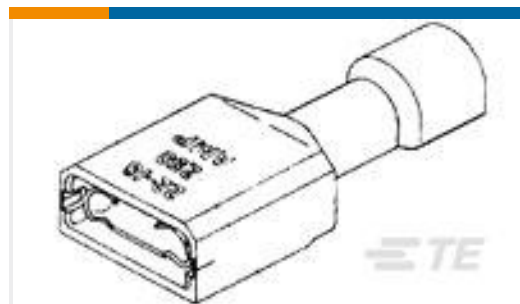

TE Part #2-520401-2
ULTRA-FAST 187 ASY REC 22-18 TPBR



TE Part #42281-2
FF 250 REC 18-14AWG TPBR

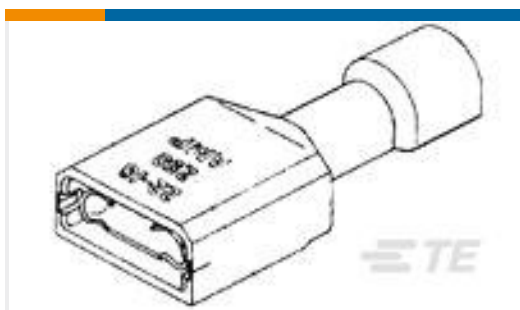

TE Part #2-520405-2
ULTRA-FAST 250 ASY REC 22-18 TPBR



TE Part #2-34147-1
PG R 22-16 COMM 22-18 MIL 6



TE Part #326854
BUDGET RING 16-14 2



TE Part #5-103958-3
5X4 MTE RCPT SR LATCH .100CL

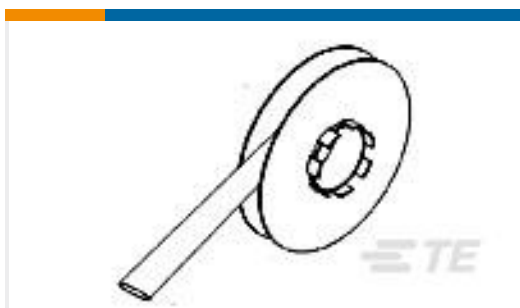

TE Part #841292-000
TTMS-2.4-9

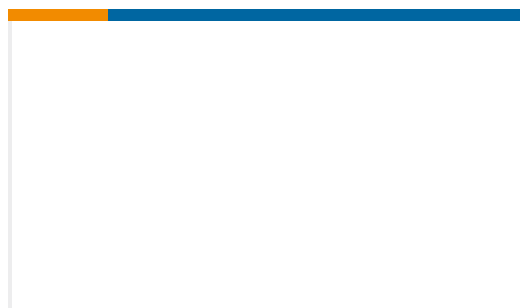

TE Part #11105401-00
10000 PSI, 7/16-20UNF, 20mV/V,
Cable, 2f

Documents



Product Drawings

TERMINAL,PIDG R IR 24 8

English

CAD Files

3D PDF

3D

Customer View Model

[ENG_CVM_CVM_2-323916-3_N.2d_dxf.zip](#)

English

Customer View Model

[ENG_CVM_CVM_2-323916-3_N.3d_igs.zip](#)

English

Customer View Model

[ENG_CVM_CVM_2-323916-3_N.3d_stp.zip](#)

English

By downloading the CAD file I accept and agree to the [Terms and Conditions](#) of use.