

## USER GUIDE

# NI USB-621x OEM

## M Series USB-6211/6212/6216/6218 OEM Devices

This document provides information about the dimensions, mounting options, connectors, and other components of the National Instruments USB-6211 OEM, USB-6212 OEM, USB-6216 OEM, and USB-6218 OEM devices. It also explains how to modify the USB device name in Microsoft Windows.



**Caution** There are no product safety, electromagnetic compatibility (EMC), or CE marking compliance claims made for the USB-6211/6212/6216/6218 OEM devices. Conformity to any and all compliance requirements rests with the end product supplier.

Figure 1 shows the USB-6211 OEM and USB-6212/6216/6218 OEM devices.

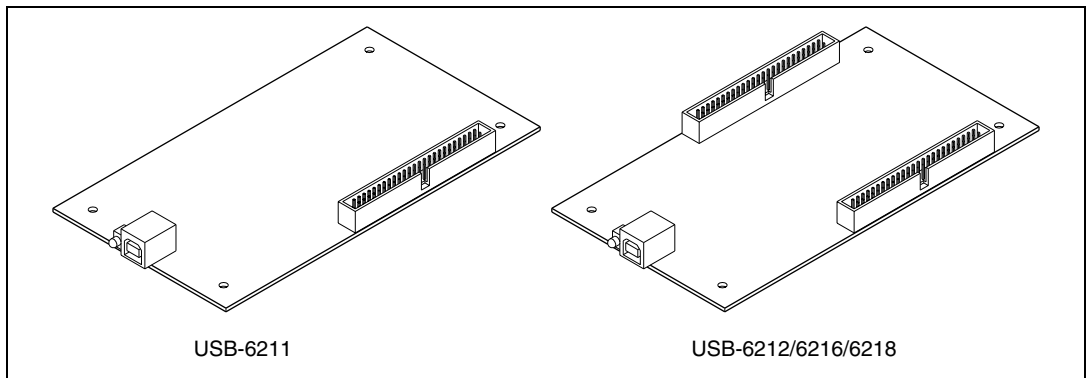
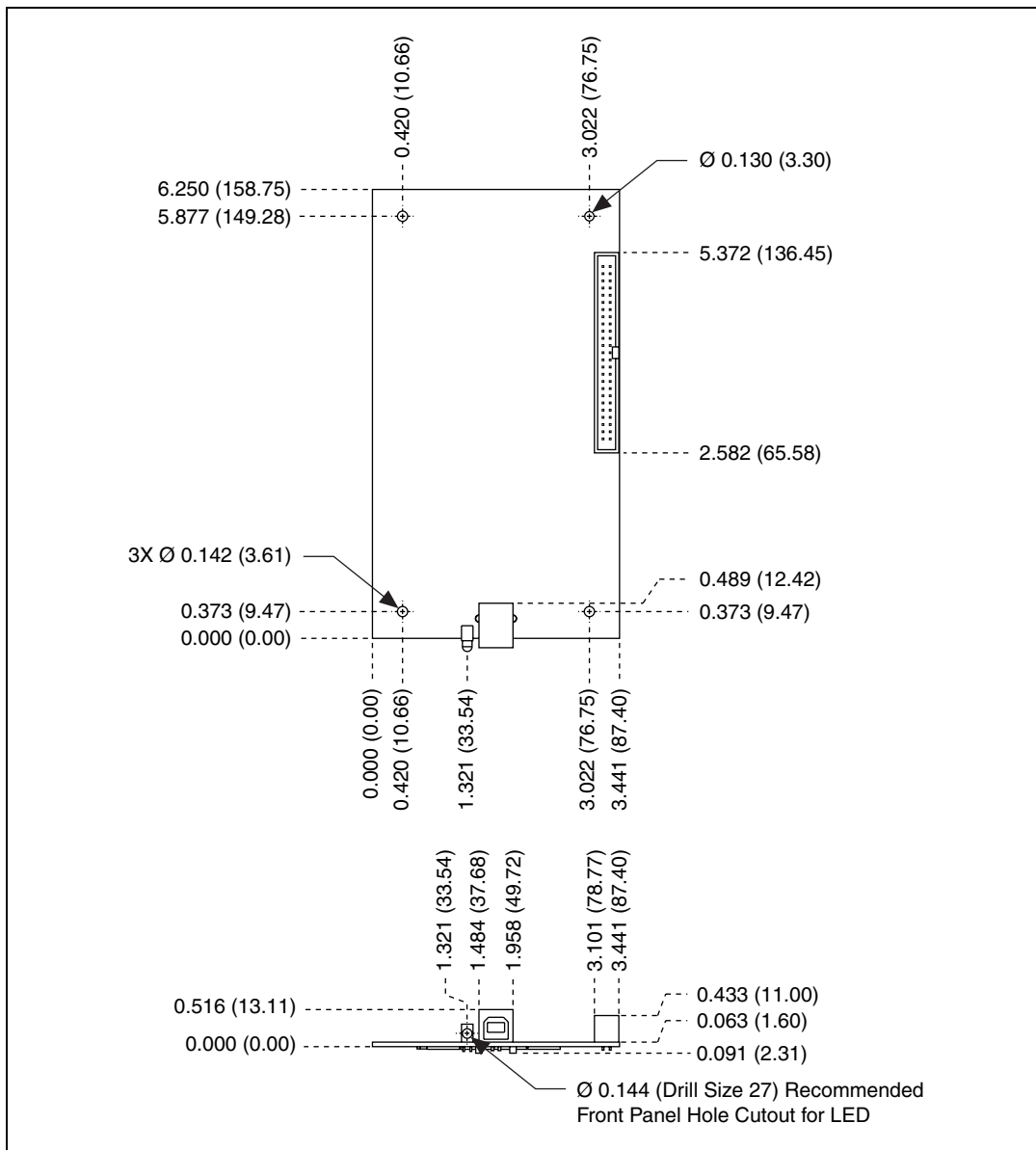

**Figure 1.** USB-621x OEM Devices

Refer to the *NI USB-621x Specifications* document for USB-6211/6212/6216/6218 specifications and the *NI USB-621x User Manual* for more information about USB-6211/6212/6216/6218 devices. You can find all documentation at [ni.com/manuals](http://ni.com/manuals).

# Dimensions

Figure 2 shows the dimensions of the USB-6211 OEM device.



**Figure 2.** USB-6211 OEM Dimensions in Inches (Millimeters)

Figure 3 shows the dimensions of the USB-6212/6216/6218 OEM device.

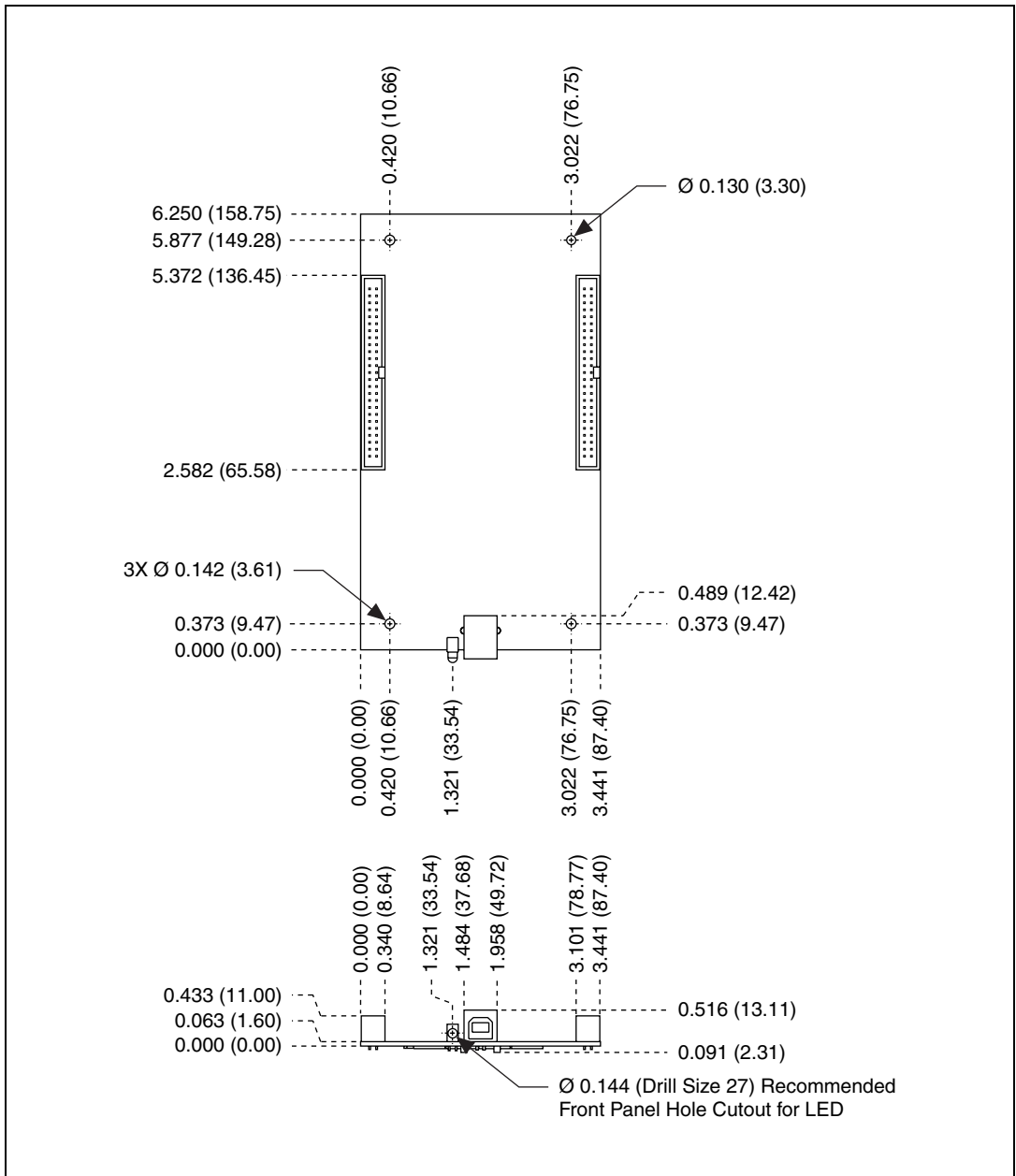
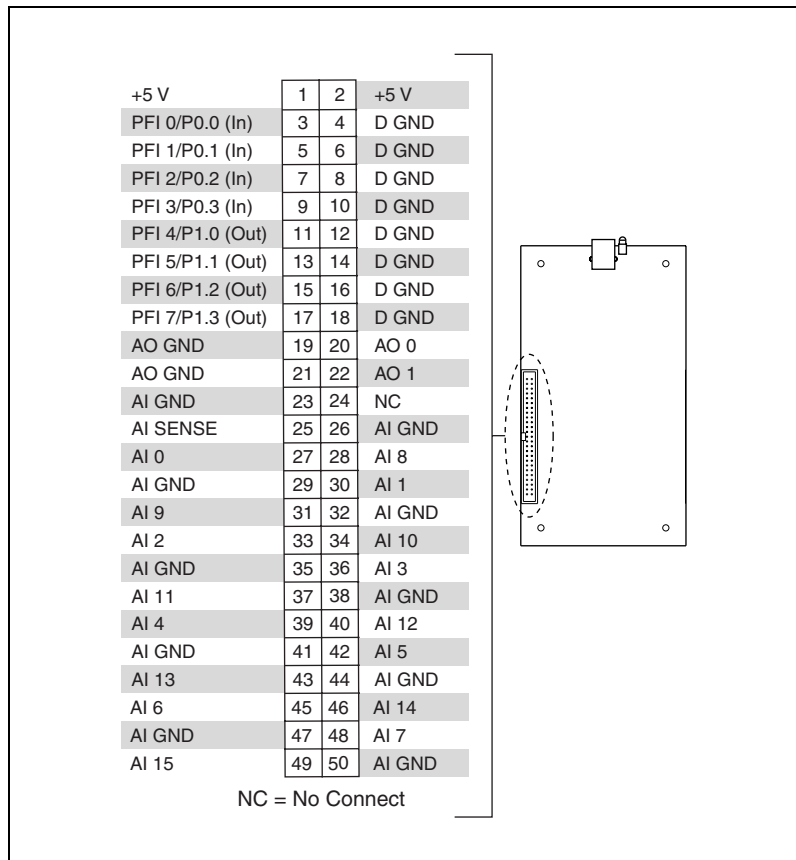

**Figure 3.** USB-6212/6216/6218 OEM Dimensions in Inches (Millimeters)

# I/O Connector Pinouts

Refer to the *NI USB-621x User Manual* at [ni.com/manuals](http://ni.com/manuals) for more information about USB-6211/6212/6216/6218 signals and how to connect them.

Figure 4 shows the connector pinout on the USB-6211 OEM device.



**Figure 4.** USB-6211 OEM Connector Pinout

Figure 5 shows the connector pinouts on the USB-6212 OEM and USB-6216 OEM devices.

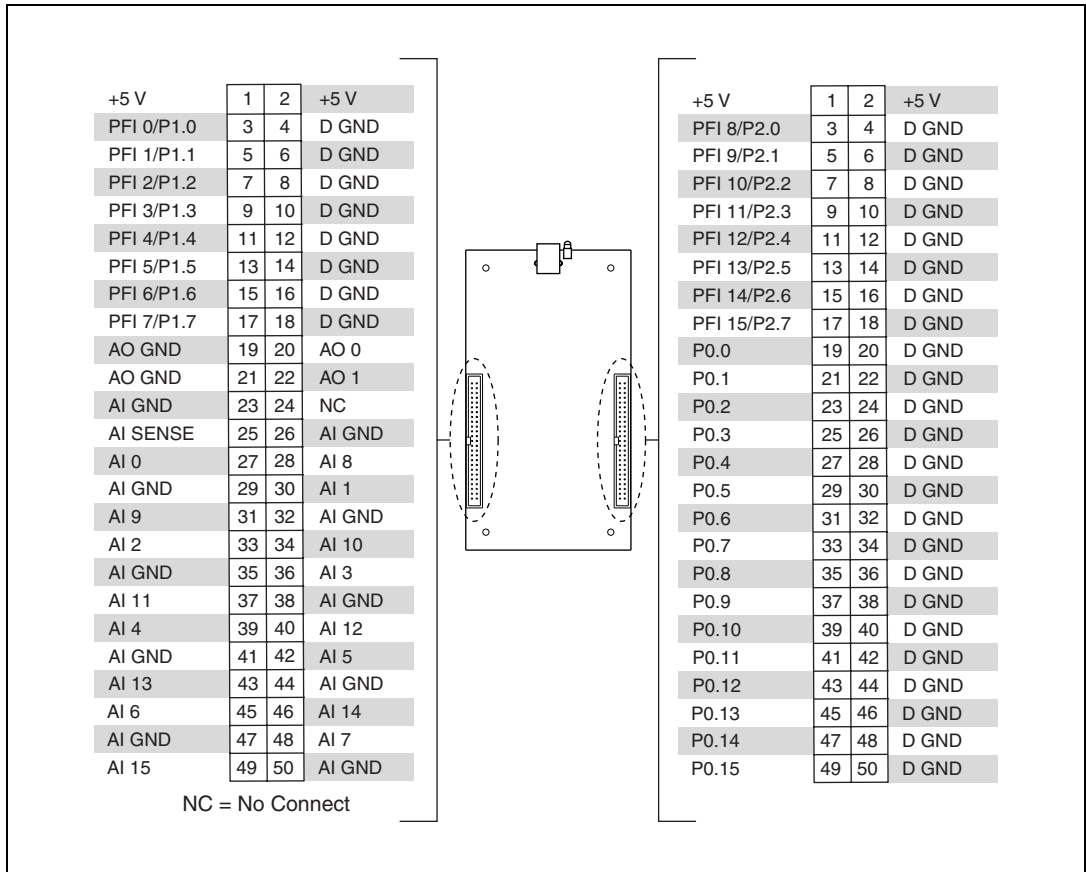
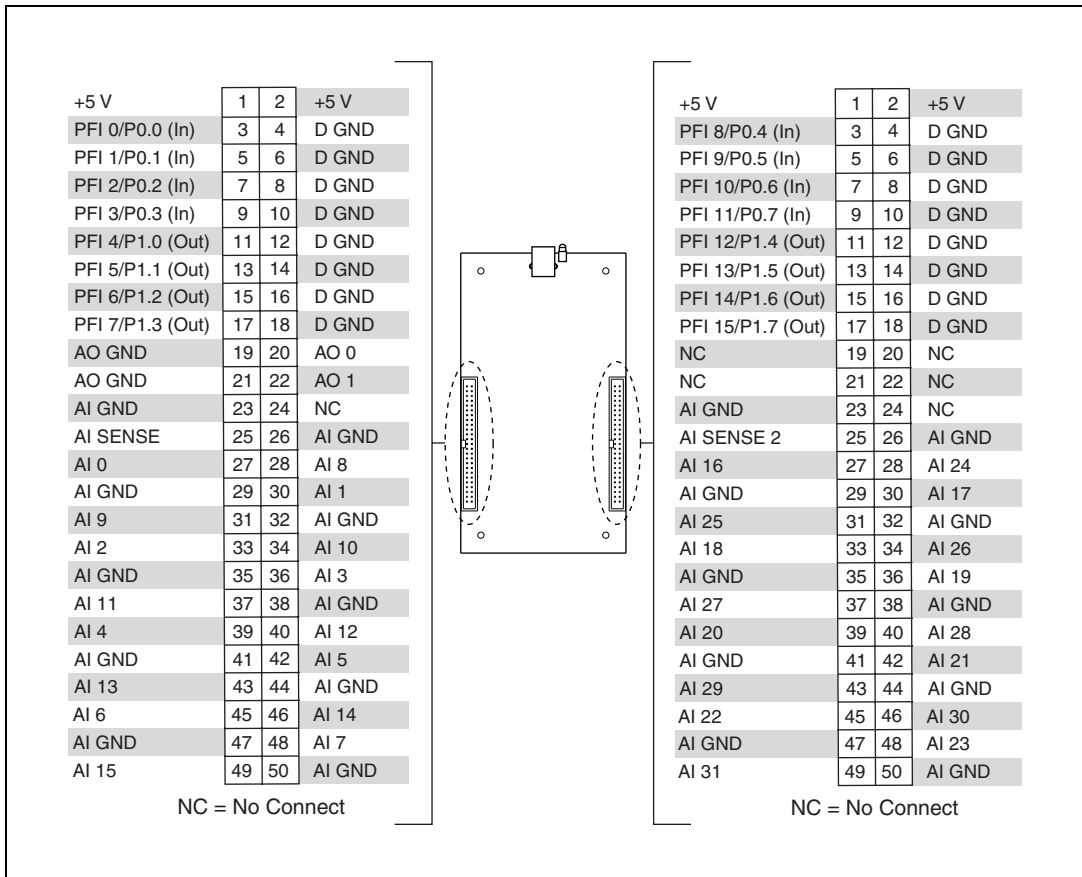

Figure 5. USB-6212/6216 OEM Connector Pinout

Figure 5 shows the connector pinouts on the USB-6218 OEM device.



**Figure 6.** USB-6218 OEM Connector Pinout



**Note** In non-referenced single-ended (NRSE) mode, the USB-6218 OEM device measures AI <0..15> relative to the AI SENSE input, and AI <16..35> relative to AI SENSE 2.

# Board Mounting the USB-621x OEM

The USB-621x OEM device can be mounted on a motherboard using the 50-pin connector(s) and board mount socket(s), as shown in Figures 7 and 8.



**Note** You can use either one or both 50-pin connectors to board mount the USB-6212/6216/6218 OEM device.

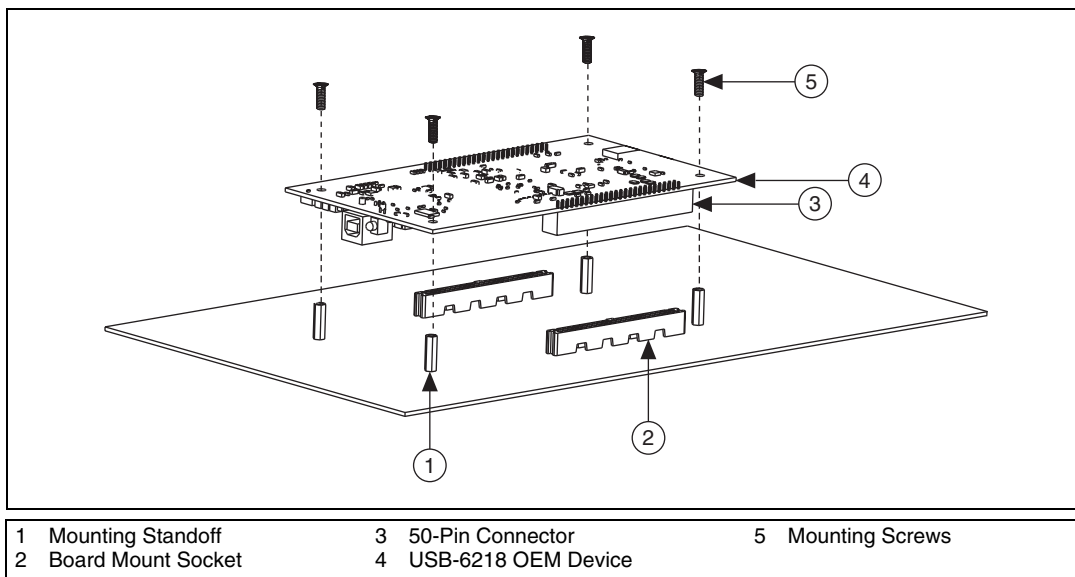

**Figure 7.** USB-621x OEM Mounting Using 50-Pin Connectors (USB-6218 OEM Device Shown)

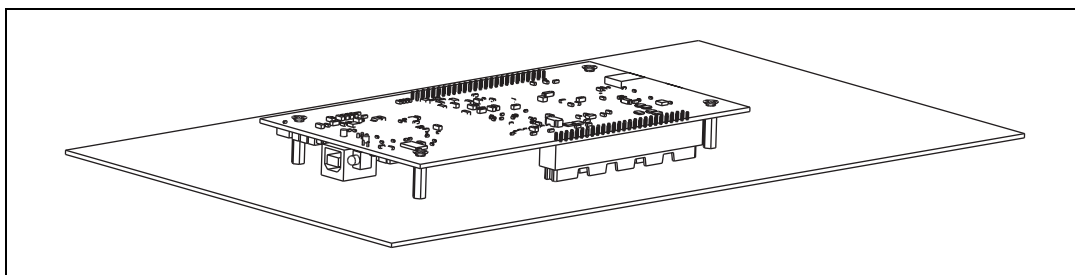

**Figure 8.** USB-621x OEM Device Installed on Motherboard (USB-6218 OEM Device Shown)

Refer to the [Device Components](#) section for more information about mounting components.

# Device Components

Table 1 contains information about the components used for interfacing and interacting with the USB-621x OEM device.

**Table 1.** USB-621x OEM Components

<b>Component</b>	<b>Reference Designator(s) on PCB</b>	<b>Manufacturer</b>	<b>Manufacturer Part Number</b>
50-pin connector	J6*, J7	3M	N2550-6002UB
USB connector	J5	AMP	787780-1
50-pin board mount socket <sup>†</sup>	—	3M	8550-4500PL (or equivalent)
Mounting standoff, using board mount socket	—	RAF Electronic Hardware	M1261-3005-SS <sup>‡</sup> with M3 × 0.5 screw
Mounting standoff, using ribbon cable	—	RAF Electronic Hardware	2053-440-SS <sup>**</sup> with 4-40 screw

\* J6 is available on USB-6212/6216/6218 OEM devices only.  
† You can use either one or both 50-pin connectors to board mount the USB-6212/6216/6218 OEM device.  
‡ 3/16 in. HEX female-to-female, 14 mm long.  
\*\* 3/16 in. HEX female-to-female, 1/4 in. long.

## Modifying the USB Device Name in Microsoft Windows

You can change how the USB-621x OEM device name appears when users install the device in both the Found New Hardware Wizard that appears when the device is initially installed and in the Windows Device Manager.

### Windows Vista/XP Users

Figure 9 depicts how a USB-6211 (OEM) device name appears in the Found New Hardware Wizard and Windows Device Manager.

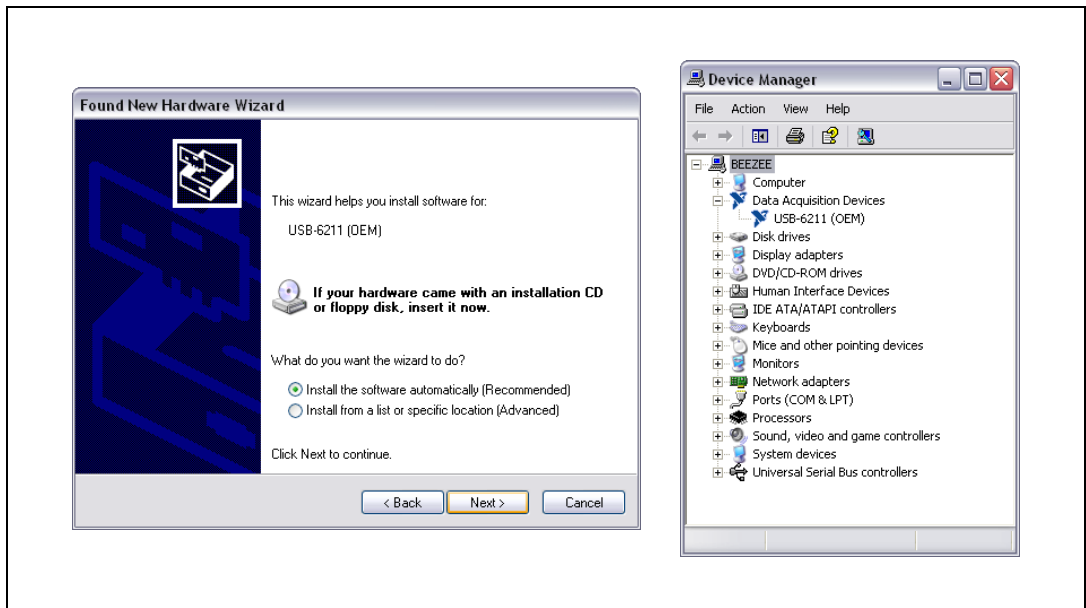

**Figure 9.** USB-6211 OEM Device in the Found New Hardware Wizard and Device Manager (Windows Vista/XP)

To modify the device name in the Found New Hardware Wizard and Windows Device Manager in Microsoft Windows Vista/XP, complete the following steps.



**Note** You *must* have NI-DAQmx 8.6 or later installed on your PC.

1. Locate the `OEMx.inf` file in the `y:\WINDOWS\inf\` directory, where `x` is the random number assigned to the INF file by Windows, and `y:\` is the root directory where Windows is installed.



**Note** New security updates to Microsoft Vista and NI-DAQ 8.6 create random INF files for NI hardware. Windows assigns random file numbers to all INF files, which causes the user to search through several INF files until the correct file is located.

If you want to revert back, save a copy of this file as `OEMx_original.inf` in a different location.

2. Edit the device INF file by opening `OEMx.inf` with a text editor.

At the bottom of this file are the descriptors where Windows looks to identify the device. Locate the two lines of text that contain in quotes the descriptors for the device name you are modifying. Change the descriptor on *both* lines to the new device name, as shown in Figure 10.

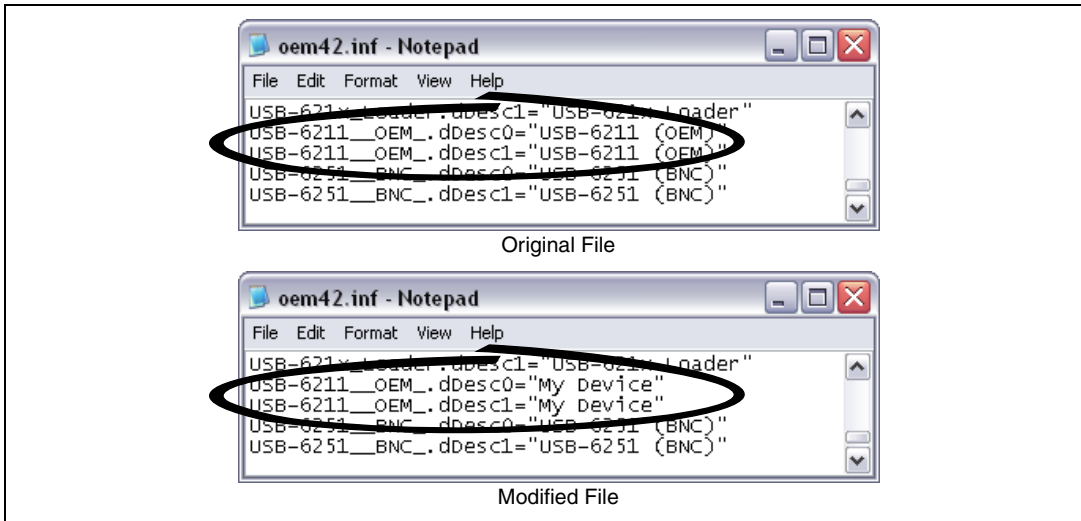

**Figure 10.** INF File Descriptors Changed to “My Device” (Windows Vista/XP)

3. Save and close the INF file.
4. Go to the Windows Device Manager.

**(Windows Vista)** In the Device Manager, notice that the OEM device now appears as `My Device`, as shown in Figure 11.

**(Windows XP)** In the Device Manager, right-click the OEM device under Data Acquisition Devices, and select **Uninstall**. Disconnect the USB cable from your PC.

When you reconnect the device, it appears as `My Device` in the Found New Hardware Wizard and Windows Device Manager, as shown in Figure 11.



**Note** When the device is initially installed, the Windows alert message may display the following: **Found New Hardware: M Series USB 621x (OEM)**. This message appears for a few seconds until the custom name appears and the Found New Hardware Wizard is launched. This alert message device name cannot be changed.

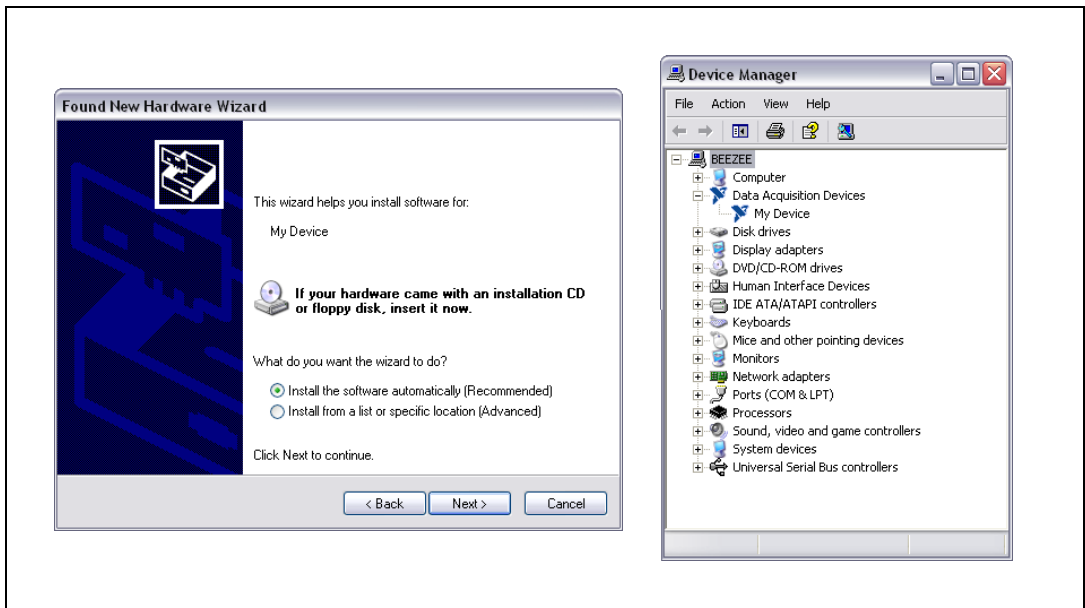

**Figure 11.** “My Device” in the Found New Hardware Wizard and Device Manager (Windows Vista/XP)



**Note** Modifying the INF file will *not* change the USB-621x OEM device name in Measurement & Automation Explorer (MAX).

## Windows 2000 Users

Figure 12 depicts how a USB-6211 (OEM) device name appears in the Found New Hardware Wizard and Windows Device Manager.

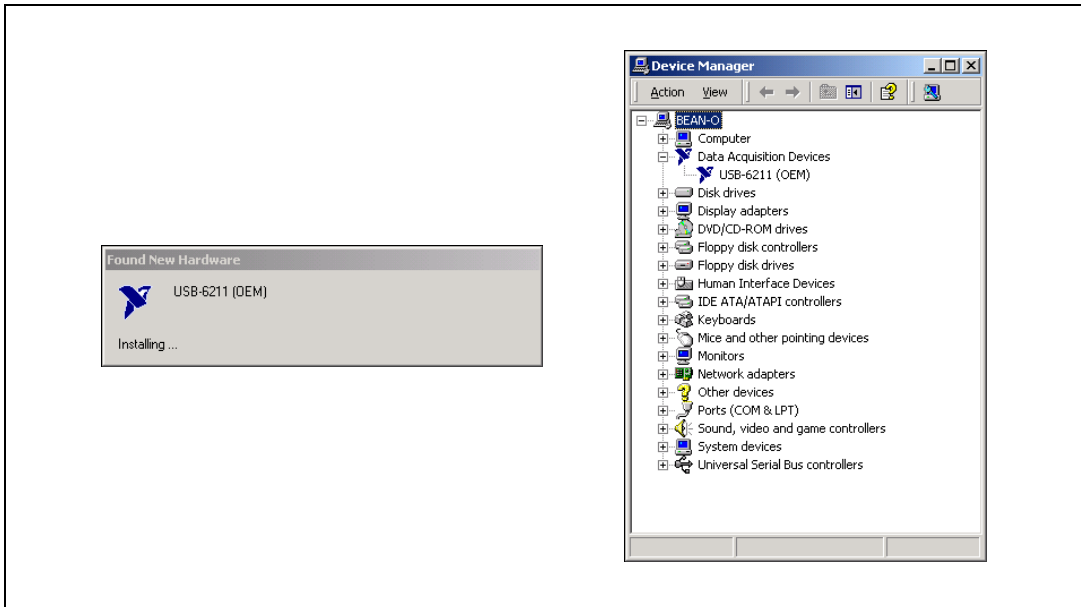

**Figure 12.** USB-6211 OEM Device in the Found New Hardware Wizard and Device Manager (Windows 2000)

To modify the device name in the Found New Hardware Wizard and Windows Device Manager in Windows 2000, complete the following steps.



**Note** You *must* have NI-DAQmx 8.6 or later installed on your PC.

1. Locate the `nimioxsu.inf` file in the `x:\WINNT\inf\` directory, where `x:\` is the root directory where Windows is installed.

If you want to revert back, save a copy of this file as `nimioxsu_original.inf` in a different location.

2. Edit the device INF file by opening `nimioxsu.inf` with a text editor. At the bottom of this file are the descriptors where Windows looks to identify the device. Locate the two lines of text that contain in quotes the descriptors for the device name you are modifying. Change the descriptor on *both* lines to the new device name, as shown in Figure 13.

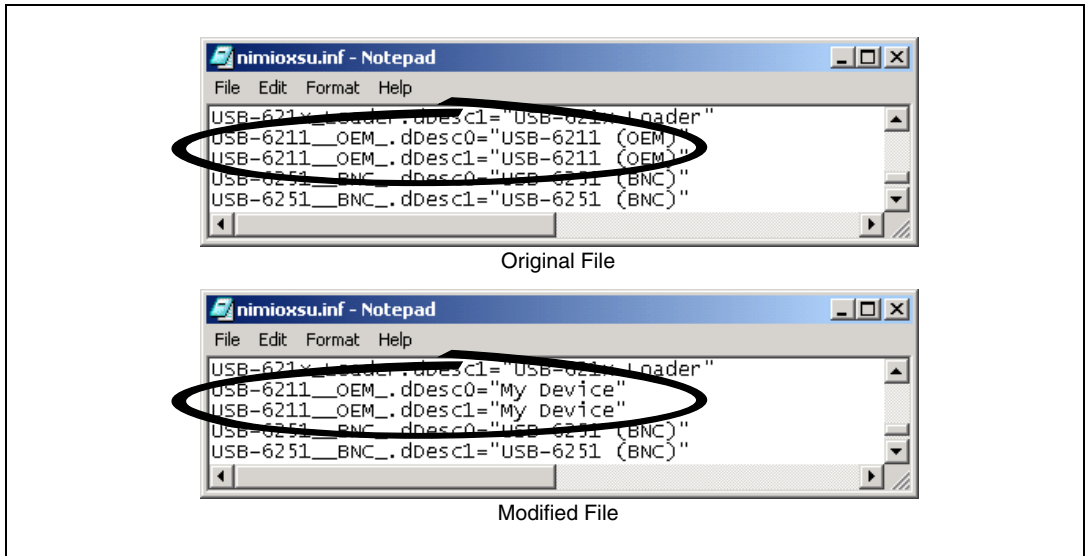

**Figure 13.** INF File Descriptors Changed to “My Device” (Windows 2000)

3. Save and close the INF file.
4. Go to the Windows Device Manager, right-click the OEM device under Data Acquisition Devices, and select **Uninstall**.
5. Disconnect the USB cable from your PC.

When you reconnect the device, it appears as `My Device` in the Found New Hardware Wizard and Windows Device Manager, as shown in Figure 14.



**Note** When the device is initially installed, the Windows alert message may display the following: **Found New Hardware: M Series USB 621x (OEM)**. This message appears for a few seconds until the custom name appears and the Found New Hardware Wizard is launched. This alert message device name cannot be changed.

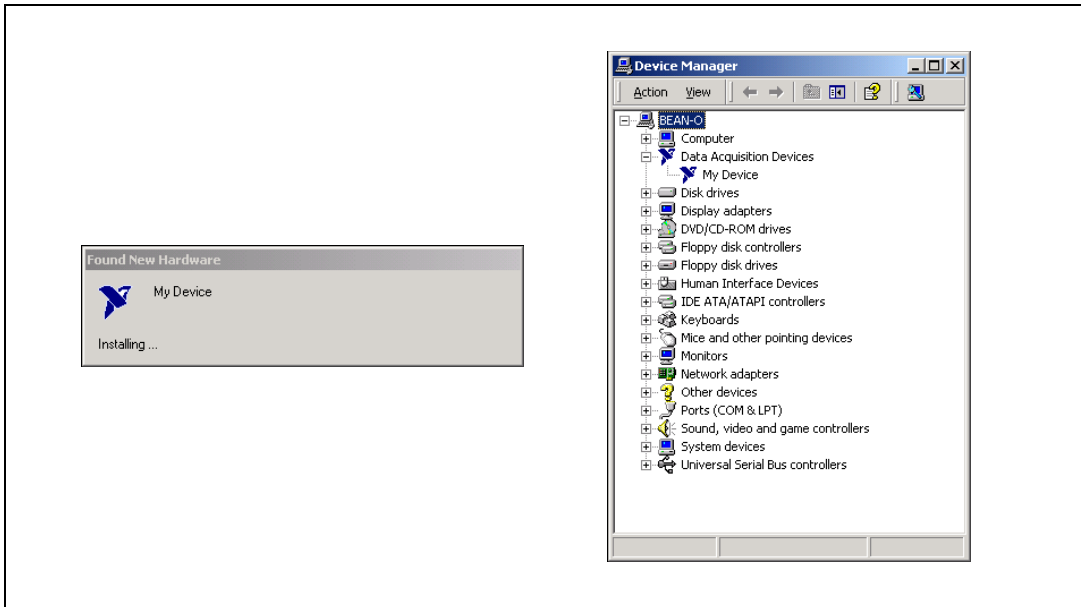

**Figure 14.** “My Device” in the Found New Hardware Wizard and Device Manager (Windows 2000)



**Note** Modifying the INF file will *not* change the USB-621x OEM device name in Measurement & Automation Explorer (MAX).

National Instruments, NI, ni.com, and LabVIEW are trademarks of National Instruments Corporation. Refer to the *Terms of Use* section on [ni.com/legal](http://ni.com/legal) for more information about National Instruments trademarks. Other product and company names mentioned herein are trademarks or trade names of their respective companies. For patents covering National Instruments products, refer to the appropriate location: **Help>Patents** in your software, the `patents.txt` file on your CD, or [ni.com/patents](http://ni.com/patents).