

1969814-1 ✓ ACTIVE

MATE-N-LOK | Universal MATE-N-LOK

TE Internal #: 1969814-1

Header, Plug, Wire-to-Board, 6 Position, 6.35 mm [.25 in]
Centerline, Printed Circuit Board, Universal MATE-N-LOK,
Rectangular Power Connectors

[View on TE.com >](#)



Connectors > Power Connectors > Rectangular Power > Rectangular Power Connectors



Rectangular Power Connector Type: **Header**

Connector & Housing Type: **Plug**

Connector System: **Wire-to-Board**

Number of Positions: **6**

Centerline (Pitch): **6.35 mm [.25 in]**

Features

Product Type Features

Rectangular Power Connector Type	Header
Connector & Housing Type	Plug
Connector System	Wire-to-Board
Sealable	No
Connector & Contact Terminates To	Printed Circuit Board

Configuration Features

Number of Positions	6
PCB Mount Orientation	Vertical
Number of Power Positions	6
Number of Rows	2

Contact Features

Contact Mating Area Plating Material	Tin
Contact Current Rating (Max)	12 A
Contact Retention Within Housing	Without



Contact Type	Pin
PCB Contact Termination Area Plating Material	Pre-Tin
Contact Mating Area Plating Material Thickness	3.81 – 5.08 µm[150 – 200 µin]

Termination Features

Termination Method to PCB	Through Hole - Solder
---------------------------	-----------------------

Mechanical Attachment

Connector Mounting Type	Board Mount
-------------------------	-------------

Housing Features

Centerline (Pitch)	6.35 mm[.25 in]
Housing Color	Natural
Housing Material	Nylon

Dimensions

Row-to-Row Spacing	6.35 mm[.25 in]
--------------------	-----------------

Usage Conditions

Operating Temperature Range	-40 – 105 °C[-40 – 221 °F]
-----------------------------	----------------------------

Operation/Application

Circuit Application	Power
---------------------	-------

Identification Marking

Circuit Identification Feature	With
--------------------------------	------

Industry Standards

UL Flammability Rating	UL 94V-0
Glow Wire Rating	GWT 750°C (Without Flame)

Packaging Features

Packaging Method	Box
------------------	-----

Product Compliance

[For compliance documentation, visit the product page on TE.com>](#)

EU RoHS Directive 2011/65/EU	Compliant
EU ELV Directive 2000/53/EC	Compliant
China RoHS 2 Directive MIIT Order No 32, 2016	No Restricted Materials Above Threshold
EU REACH Regulation (EC) No. 1907/2006	Current ECHA Candidate List: JUNE 2024 (241)









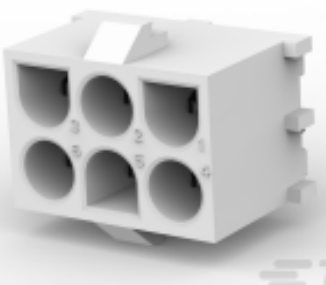

Candidate List Declared Against: JUNE 2024 (241)
Does not contain REACH SVHC

Halogen Content	Not Low Halogen - contains Br or Cl > 900 ppm.
Solder Process Capability	Not reviewed for solder process capability

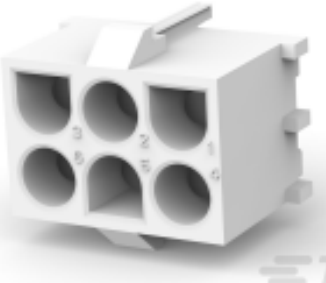
Product Compliance Disclaimer

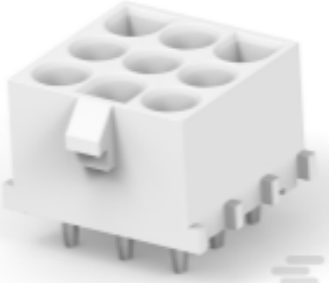
This information is provided based on reasonable inquiry of our suppliers and represents our current actual knowledge based on the information they provided. This information is subject to change. The part numbers that TE has identified as EU RoHS compliant have a maximum concentration of 0.1% by weight in homogenous materials for lead, hexavalent chromium, mercury, PBB, PBDE, DBP, BBP, DEHP, DIBP, and 0.01% for cadmium, or qualify for an exemption to these limits as defined in the Annexes of Directive 2011/65/EU (RoHS2). Finished electrical and electronic equipment products will be CE marked as required by Directive 2011/65/EU. Components may not be CE marked. Additionally, the part numbers that TE has identified as EU ELV compliant have a maximum concentration of 0.1% by weight in homogenous materials for lead, hexavalent chromium, and mercury, and 0.01% for cadmium, or qualify for an exemption to these limits as defined in the Annexes of Directive 2000/53/EC (ELV). Regarding the REACH Regulation, the information TE provides on SVHC in articles for this part number is based on the latest European Chemicals Agency (ECHA) 'Guidance on requirements for substances in articles' posted at this URL: <https://echa.europa.eu/guidance-documents/guidance-on-reach>

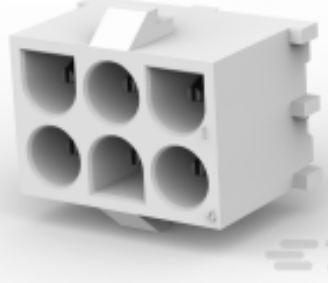
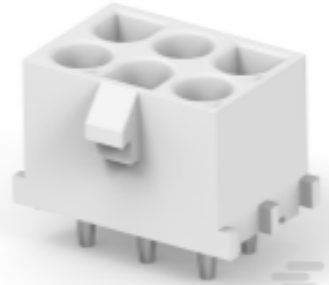
Compatible Parts

 <p>TE Part # 350732-1 06P UMNL PIN HDR ASSY 94VO</p>	 <p>TE Part # 350711-1 06P UMNL PIN HDR ASSY 94VO</p>	 <p>TE Part # 350431-1 06P UMNL PIN HDR ASSY V2 NAT</p>	 <p>TE Part # 1586174-1 06P UMNL PIN HDR 94VO NDH</p>
 <p>TE Part # 643424-1 06P UMNL HDR ASSY POL 94VO</p>	 <p>TE Part # 1969807-1 04P UMNL PIN HDR ASSY, PIN V0 GW</p>	 <p>TE Part # 1969818-1 09P UMNL PIN HDR ASSY NATL, PIN V0 GW</p>	 <p>TE Part # 1586090-1 06P UMNL PINHDR NO DRAIN HOLE</p>
 <p>TE Part # 1969809-1 05P UMNL PIN HDR ASSY, PIN RA V0 GW</p>	 <p>TE Part # 350585-1 06P UMNL PIN HDR ASSY V2 NATL</p>	 <p>TE Part # 1969811-1 06P UMNL SKT HDR ASSY, SCKT V0 GW</p>	 <p>TE Part # 1969799-1 02P UMNL PIN HDR ASSY POL, PIN V0 GW</p>



TE Part # 1969830-1
6P UMNL SKT ASSY GW



TE Part # 643253-1
06P UMNL ASSY MOD HSG VO

Also in the Series | Universal MATE-N-LOK

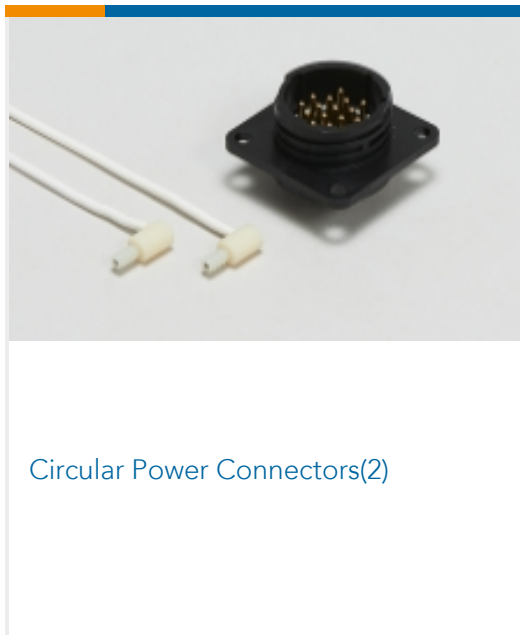

Circular Power Connectors(2)

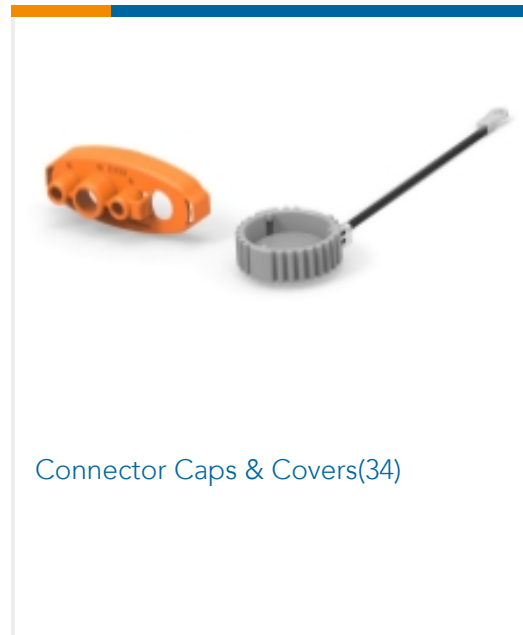

Connector Caps & Covers(34)

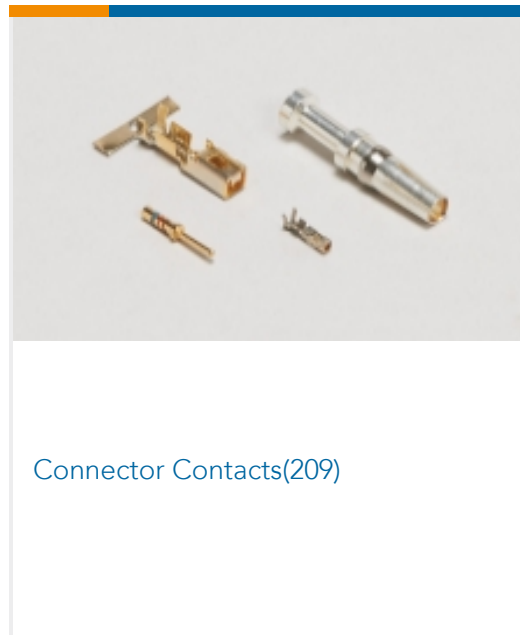

Connector Contacts(209)

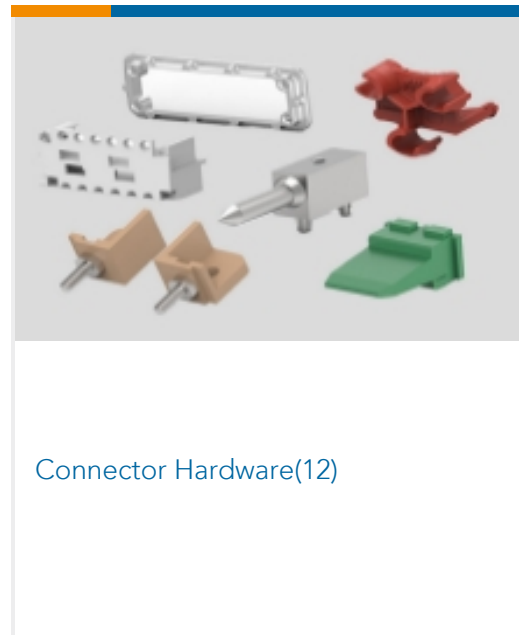

Connector Hardware(12)

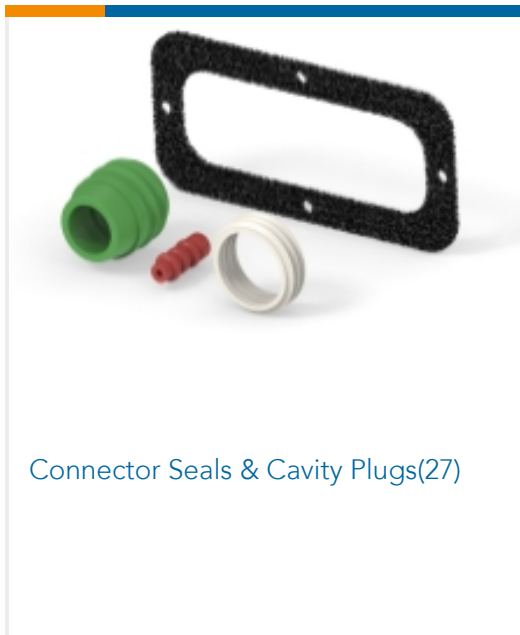

Connector Seals & Cavity Plugs(27)

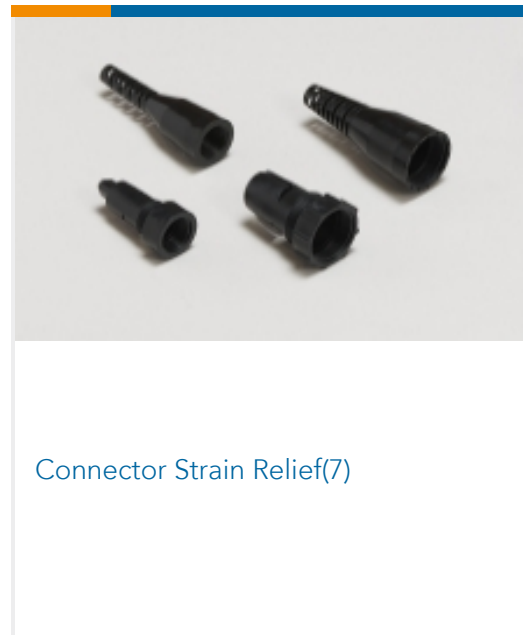

Connector Strain Relief(7)

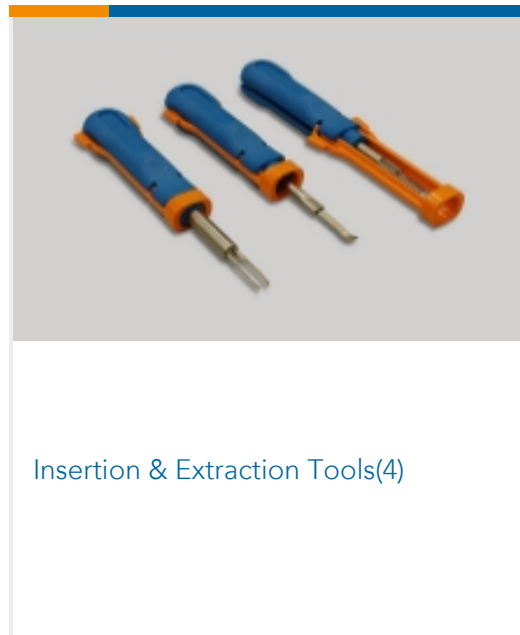

Insertion & Extraction Tools(4)

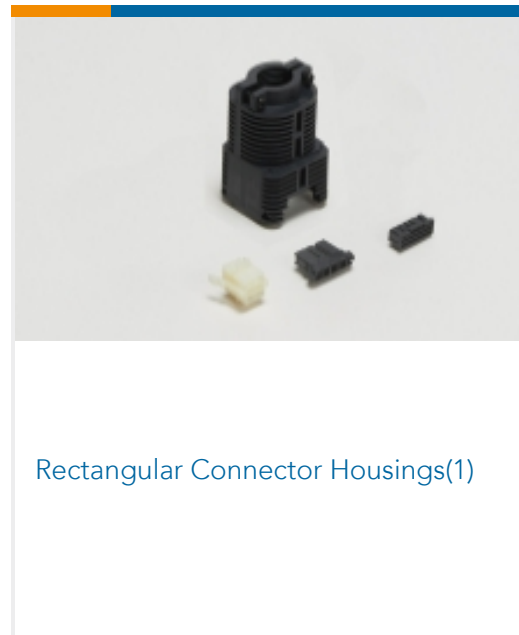

Rectangular Connector Housings(1)



Rectangular Power Connectors(670)

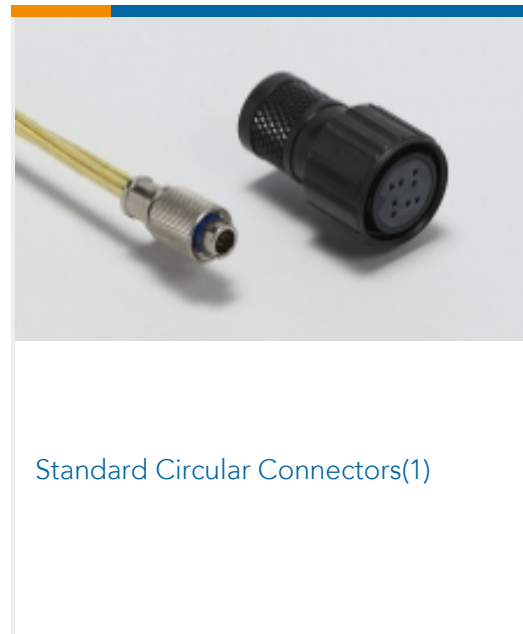

Standard Circular Connectors(1)

Customers Also Bought



TE Part #180384-2
FF 250 REC 4-6MM2 PTBR LP



TE Part #140805-2
TERMINAL REC FASTON PIDG 5

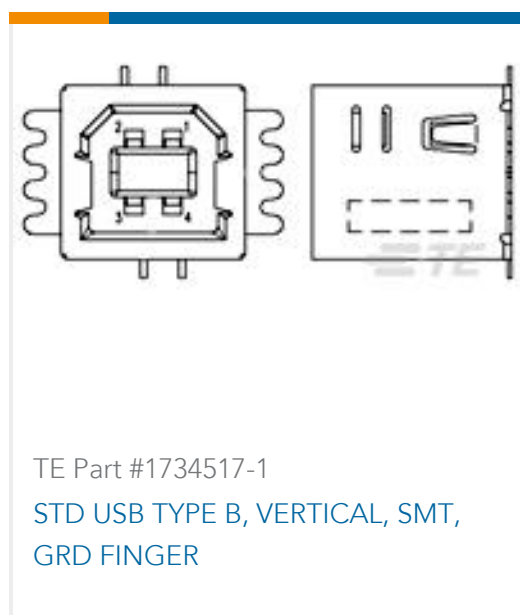

TE Part #1734517-1
STD USB TYPE B, VERTICAL, SMT,
GRD FINGER



TE Part #6-1437624-0
PKG50B1/4=KNOB PLASTIC 1/4 LEX

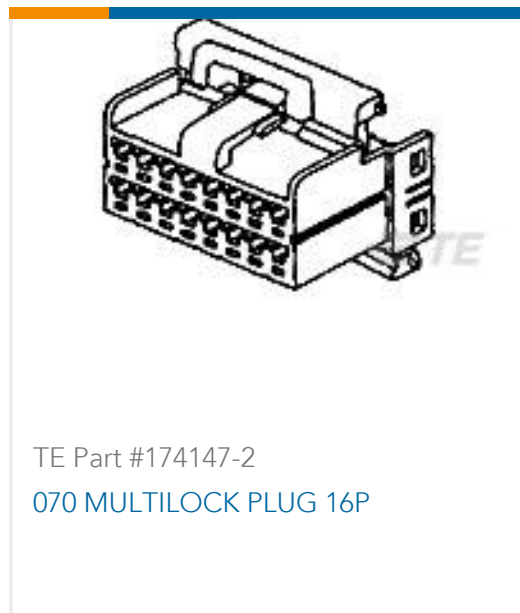

Documents

Product Drawings

[06P UMNL PIN HDR ASSY, PIN V0 GW](#)

English

CAD Files

[3D PDF](#)

3D

Customer View Model

[ENG_CVM_CVM_1969814-1_A.2d_dxf.zip](#)

English

Customer View Model

[ENG_CVM_CVM_1969814-1_A.3d_igs.zip](#)

English

Customer View Model

[ENG_CVM_CVM_1969814-1_A.3d_stp.zip](#)

English

By downloading the CAD file I accept and agree to the [Terms and Conditions](#) of use.

Product Specifications

[Application Specification](#)

English

Agency Approvals

[VDE Certificate](#)

English