

1969591-2 ✓ ACTIVE

Economy Power 2.5

TE Internal #: 1969591-2

Economy Power 2.5, Housing, Receptacle, Wire-to-Panel / Wire-to-Wire, 2 Position, .098in [2.5mm] Centerline, Crimp, 1 Row, Natural, Mating Retention

[View on TE.com >](#)



Connectors > PCB Connectors > Wire-to-Board Connectors > Wire-to-Board Connector Assemblies & Housings

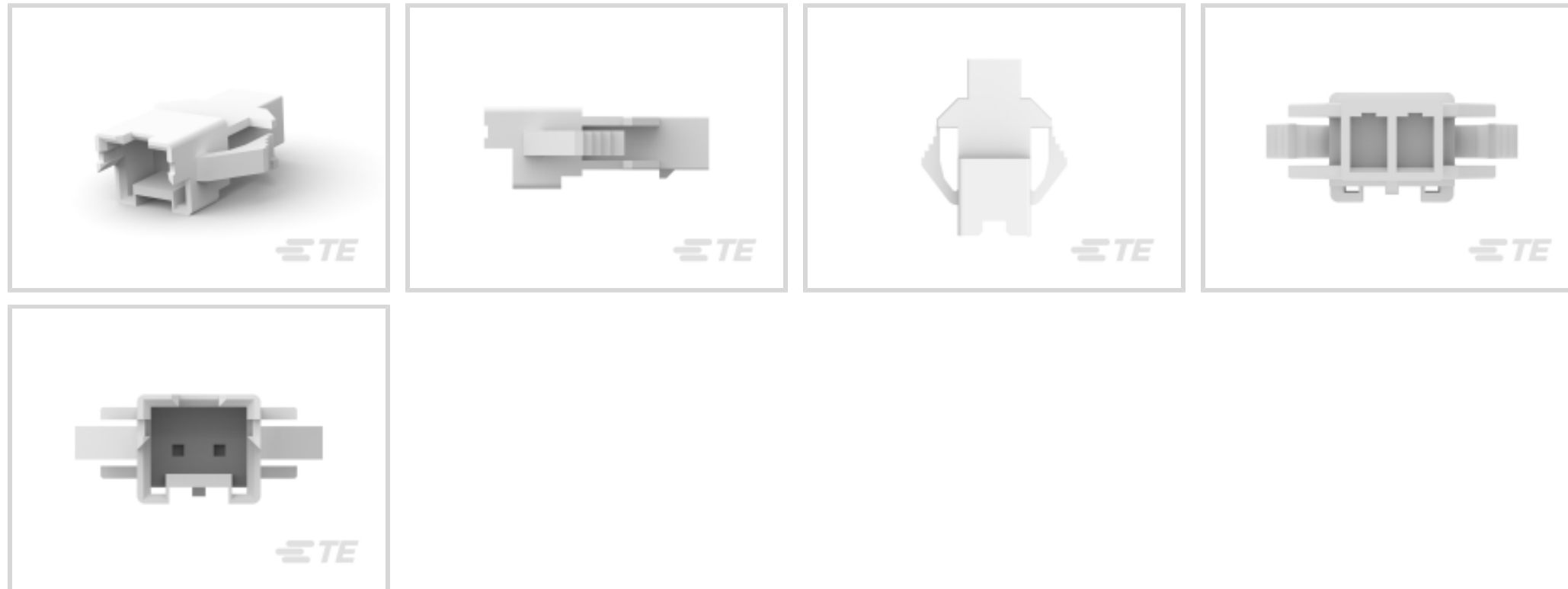

Connector Product Type: **Housing**

Connector & Housing Type: **Receptacle**

Connector System: **Wire-to-Panel, Wire-to-Wire**

Number of Positions: **2**

Centerline (Pitch): **2.5 mm [.098 in]**

Features

Product Type Features

Connector Product Type	Housing
Connector & Housing Type	Receptacle
Connector System	Wire-to-Panel, Wire-to-Wire
Sealable	No
Connector & Contact Terminates To	Wire & Cable

Configuration Features

Number of Positions	2
Number of Rows	1

Electrical Characteristics

Operating Voltage	250 VAC
-------------------	---------

Contact Features

Contact Type	Pin
Contact Current Rating (Max)	7.5 A



Termination Features

Termination Method to Wire & Cable	Crimp
------------------------------------	-------

Mechanical Attachment

Strain Relief	Without
Panel Mount Feature	With
PCB Mount Retention	Without
Mating Retention Type	Latch
Mating Retention	With
Connector Mounting Type	Panel Mount

Housing Features

Housing Entry Configuration	Both Ends Closed
Housing Material	Nylon - GF
Centerline (Pitch)	2.5 mm[.098 in]
Housing Color	Natural

Dimensions

Connector Length	7.5 mm[.295 in]
Connector Height	6.6 mm[.26 in]
Connector Width	18.17 mm[.715 in]
Accepts Wire Insulation Diameter Range	1.3 – 1.7 mm[.051 – .067 in]
Wire Size	.13 – .33 mm ²

Usage Conditions

Operating Temperature Range	-25 – 105 °C[-13 – 221 °F]
-----------------------------	----------------------------

Operation/Application

Circuit Application	Power & Signal
---------------------	----------------

Industry Standards

Glow Wire Rating	Glow Wire
UL Flammability Rating	UL 94V-0

Packaging Features

Packaging Quantity	10000
Packaging Method	Bag

Other

Comment	Panel Mount
---------	-------------



Product Compliance





[For compliance documentation, visit the product page on TE.com>](#)

EU RoHS Directive 2011/65/EU	Compliant
EU ELV Directive 2000/53/EC	Compliant
China RoHS 2 Directive MIIT Order No 32, 2016	No Restricted Materials Above Threshold
EU REACH Regulation (EC) No. 1907/2006	Current ECHA Candidate List: JUL 2021 (219) Candidate List Declared Against: JUL 2021 (219) Does not contain REACH SVHC
Halogen Content	Not Low Halogen - contains Br or Cl > 900 ppm.
Solder Process Capability	Not reviewed for solder process capability

Product Compliance Disclaimer

This information is provided based on reasonable inquiry of our suppliers and represents our current actual knowledge based on the information they provided. This information is subject to change. The part numbers that TE has identified as EU RoHS compliant have a maximum concentration of 0.1% by weight in homogenous materials for lead, hexavalent chromium, mercury, PBB, PBDE, DBP, BBP, DEHP, DIBP, and 0.01% for cadmium, or qualify for an exemption to these limits as defined in the Annexes of Directive 2011/65/EU (RoHS2). Finished electrical and electronic equipment products will be CE marked as required by Directive 2011/65/EU. Components may not be CE marked. Additionally, the part numbers that TE has identified as EU ELV compliant have a maximum concentration of 0.1% by weight in homogenous materials for lead, hexavalent chromium, and mercury, and 0.01% for cadmium, or qualify for an exemption to these limits as defined in the Annexes of Directive 2000/53/EC (ELV). Regarding the REACH Regulation, the information TE provides on SVHC in articles for this part number is based on the latest European Chemicals Agency (ECHA) 'Guidance on requirements for substances in articles' posted at this URL: <https://echa.europa.eu/guidance-documents/guidance-on-reach>

Compatible Parts

 <p>TE Part # 1969589-2 HSG, REC, FREE-HANG, GWT, SINGLE ROW, EP2.5</p>	 <p>TE Part # 1969590-2 HSG, REC, PANEL MOUNT, SINGLE ROW, EP2.5</p>	 <p>TE Part # 1969591-4 HSG, REC, PANEL MOUNT, GWT, SINGLE ROW, EP2.5</p>	 <p>TE Part # 1969591-6 HSG, REC, PANEL MOUNT, GWT, SINGLE ROW, EP2.5</p>
--	---	--	--



Also in the Series | Economy Power 2.5

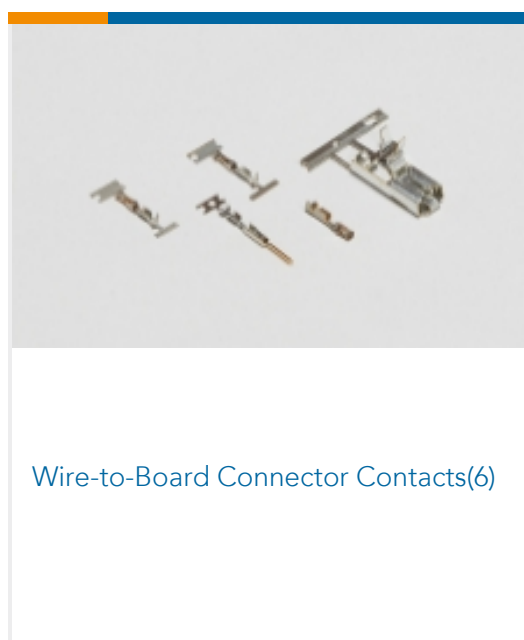
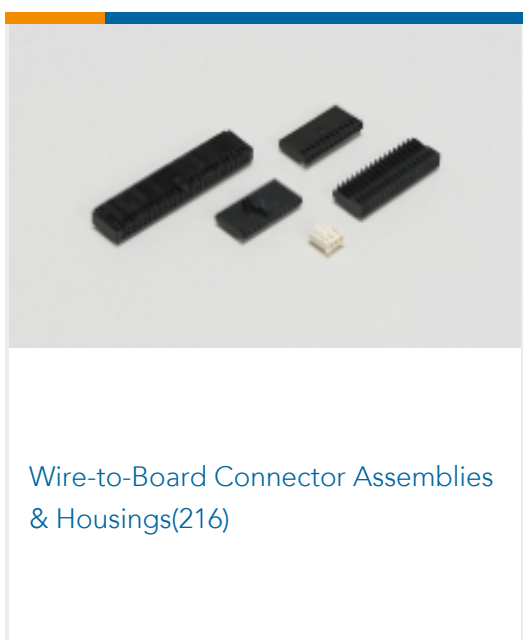
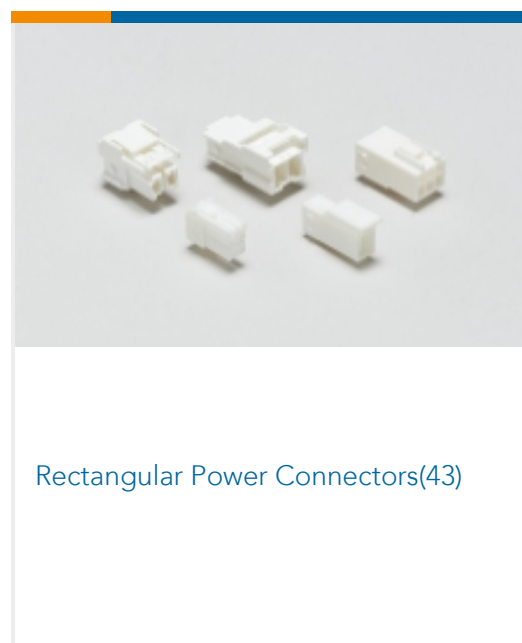
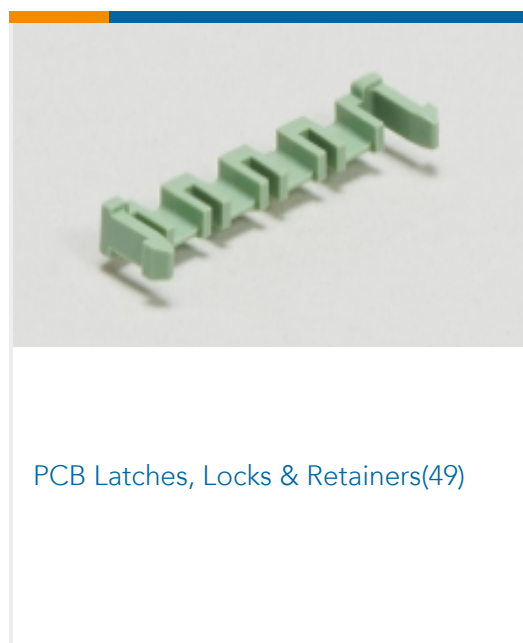
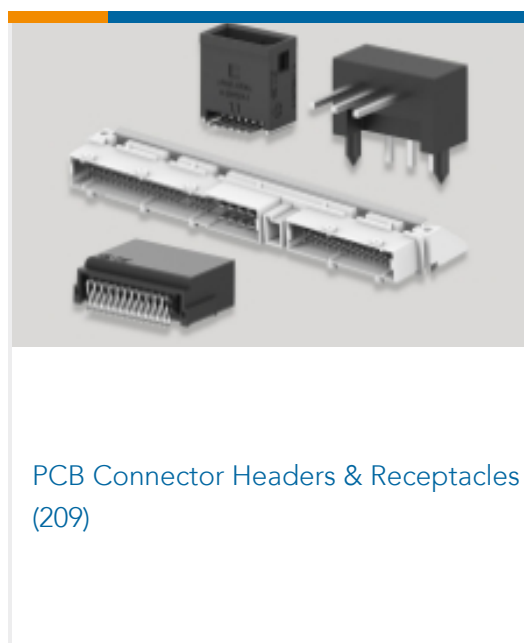
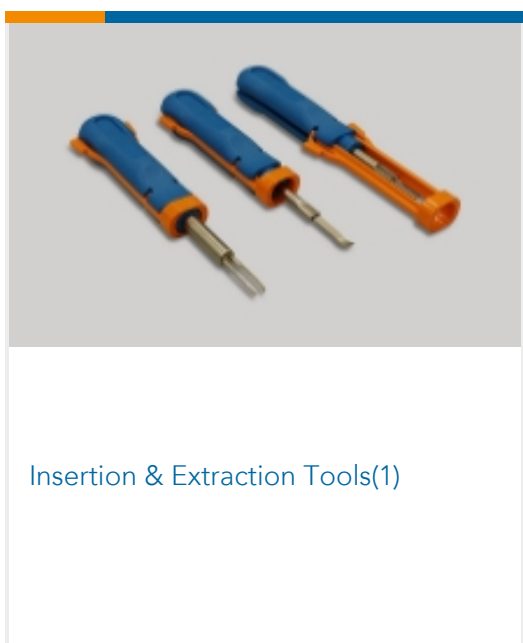

Customers Also Bought



TE Part #0460-202-16141
DEUTSCH SOLID CONTACTS



TE Part #282104-1
AMP SUPERSEAL 1.5MM,
CONNECTOR HOUSING



TE Part #206070-8
CABLE CLAMP KIT #17

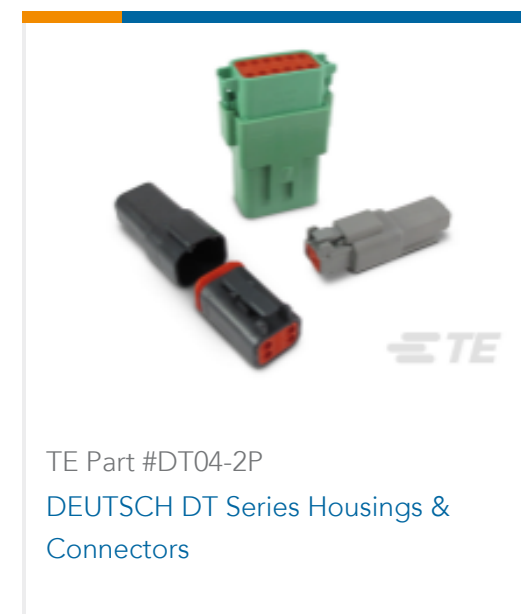

TE Part #DT04-2P
DEUTSCH DT Series Housings &
Connectors



TE Part #W2S
DEUTSCH DT WEDGELOCKS

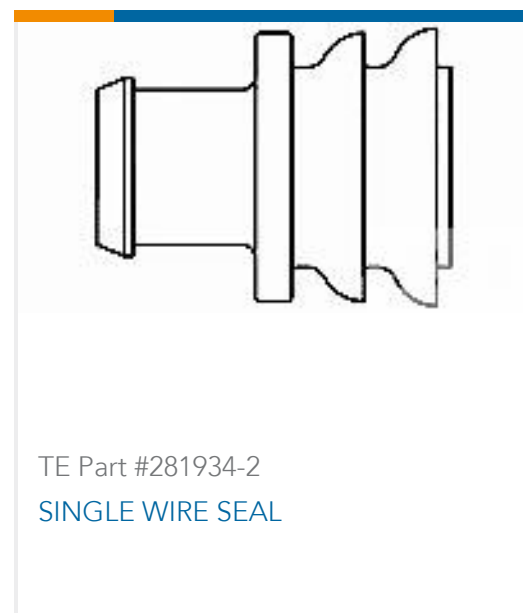

TE Part #281934-2
SINGLE WIRE SEAL

Documents

Product Drawings

[HSG,REC,PANEL MOUNT,GWT,SINGLE ROW,EP2.5](#)

English

CAD Files

[3D PDF](#)

3D

Customer View Model

[ENG_CVM_CVM_1969591-2_B.2d_dxf.zip](#)

English

Customer View Model

[ENG_CVM_CVM_1969591-2_B.3d_igs.zip](#)

English

Customer View Model

[ENG_CVM_CVM_1969591-2_B.3d_stp.zip](#)

English

By downloading the CAD file I accept and agree to the [Terms and Conditions](#) of use.

Product Specifications

[Application Specification](#)

English

Product Environmental Compliance

[TE Material Declaration](#)

English

Instruction Sheets

[Instruction Sheet \(U.S.\)](#)



English

[Agency Approvals](#)

[VDE Certificate](#)

English