

CCV 2,5/ 8-G-5,08 P26THR - PCB header



1955471

<https://www.phoenixcontact.com/de/produkte/1955471>

Please be informed that the data shown in this PDF document is generated from our Online Catalog. Please find the complete data in the user documentation. Our General Terms of Use for Downloads are valid.



PCB headers, nominal cross section: 2.5 mm², color: black, nominal current: 12 A, rated voltage (III/2): 320 V, contact surface: Tin, type of contact: Male connector, number of potentials: 8, number of rows: 1, number of positions: 8, number of connections: 8, product range: CCV 2,5/..-G, pitch: 5.08 mm, mounting: THR soldering, pin layout: Linear pinning, solder pin [P]: 2.6 mm, number of solder pins per potential: 1, plug-in system: COMBICON MSTB 2,5, Pin connector pattern alignment: Standard, locking: without, mounting: without, type of packaging: packed in cardboard, For user information and design recommendations for through-hole reflow technology, go to: Downloads

Your advantages

- Designed for integration into the SMT soldering process
- Vertical connection enables multi-row arrangement on the PCB
- Maximum flexibility when it comes to device design – one header for connectors with different connection technologies

Commercial Data

Item number	1955471
Packing unit	50 pc
Minimum order quantity	50 pc
Sales Key	E1 - Leiterplattenanschl.
Product Key	AACTBG
Catalog Page	Page 236 (CC-2009)
GTIN	4017918926236
Weight per Piece (including packing)	3,12 g
Weight per Piece (excluding packing)	2,67 g
Customs tariff number	85366930
Country of origin	DE

1955471

<https://www.phoenixcontact.com/de/produkte/1955471>

Technical Data

Product properties

Type	Component suitable for through hole reflow
Product line	COMBICON Connectors M
Product type	PCB headers
Product family	CCV 2,5/..-G
Number of positions	8
Pitch	5.08 mm
Number of connections	8
Number of rows	1
Mounting flange	without
Number of potentials	8
Pin layout	Linear pinning
Solder pins per potential	1

Electrical properties

Nominal current I_N	12 A
Nominal voltage U_N	320 V
Degree of pollution	3
Contact resistance	1.2 m Ω
Rated voltage (III/3)	250 V
Rated surge voltage (III/3)	4 kV
Rated voltage (III/2)	320 V
Rated surge voltage (III/2)	4 kV
	400 V
Rated surge voltage (II/2)	4 kV

Mounting

Mounting type	THR soldering
Pin layout	Linear pinning

Processing notes

Process	Reflow/wave soldering
Moisture Sensitive Level	MSL 1
Classification temperature T_c	260 °C
Solder cycles in the reflow	3

Material specifications

Material data - contact

Note	WEEE/RoHS-compliant, free of whiskers according to IEC 60068-2-82/JEDEC JESD 201
Contact material	Cu alloy
Surface characteristics	Tin-plated

CCV 2,5/ 8-G-5,08 P26THR - PCB header



1955471

<https://www.phoenixcontact.com/de/produkte/1955471>

Metal surface contact area (top layer)	Tin (3 - 5 µm Sn)
Metal surface contact area (middle layer)	Nickel (1.3 - 3 µm Ni)
Metal surface soldering area (top layer)	Tin (3 - 5 µm Sn)
Metal surface soldering area (middle layer)	Nickel (1.3 - 3 µm Ni)

Material data - housing

Color (Housing)	black (9005)
Insulating material	LCP
Insulating material group	IIIa
CTI according to IEC 60112	175
Flammability rating according to UL 94	V0

Material data – actuating element

Color ()	()
-----------	-----

Notes

Details for soldering processes	Processing using reflow processes in compliance with IEC 60068-2-58 or DIN EN 61760-1 (latest version) Moisture Sensitive Level (MSL) = 1 according to IPC/JEDEC J-STD-020-C
---------------------------------	---

Dimensions

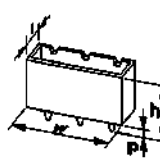
Dimensional drawing	
Pitch	5.08 mm
Width [w]	40.24 mm
Height [h]	14.6 mm
Length [l]	8.6 mm
Installed height	12 mm
Solder pin length [P]	2.6 mm

Mechanical tests

Test for conductor damage and slackening

Specification	IEC 60999-1:1999-11
Result	Test passed

Pull-out test

Specification	IEC 60999-1:1999-11
Conductor cross section/conductor type/tractive force setpoint/actual value	0.2 mm ² / solid / > 10 N
	0.2 mm ² / flexible / > 10 N
	2.5 mm ² / solid / > 50 N
	2.5 mm ² / flexible / > 50 N

1955471

<https://www.phoenixcontact.com/de/produkte/1955471>

Insertion and withdrawal forces

Result	Test passed
No. of cycles	25
Insertion strength per pos. approx.	8 N
Withdraw strength per pos. approx.	6 N

Torque test

Specification	IEC 60999-1:1999-11
---------------	---------------------

Contact holder in insert

Specification	IEC 60512-15-1:2008-05
Contact holder in insert Requirements >20 N	Test passed

Resistance of inscriptions

Specification	IEC 60068-2-70:1995-12
Result	Test passed

Polarization and coding

Specification	IEC 60512-13-5:2006-02
Result	Test passed

Visual inspection

Specification	IEC 60512-1-1:2002-02
Result	Test passed

Dimension check

Specification	IEC 60512-1-2:2002-02
Result	Test passed

Electrical tests

Thermal test | Test group C

Specification	IEC 60512-5-1:2002-02
Tested number of positions	12

Insulation resistance

Specification	IEC 60512-3-1:2002-02
Insulation resistance, neighboring positions	> 5 MΩ

Air clearances and creepage distances |

Specification	IEC 60664-1:2007-04
Insulating material group	IIIa
Comparative tracking index (IEC 60112)	CTI 175
Rated insulation voltage (III/3)	250 V
Rated surge voltage (III/3)	4 kV
minimum clearance value - non-homogenous field (III/3)	3 mm
minimum creepage distance (III/3)	4 mm

CCV 2,5/ 8-G-5,08 P26THR - PCB header



1955471

<https://www.phoenixcontact.com/de/produkte/1955471>

Rated insulation voltage (III/2)	320 V
Rated surge voltage (III/2)	4 kV
minimum clearance value - non-homogenous field (III/2)	3 mm
minimum creepage distance (III/2)	3.2 mm
Rated insulation voltage (II/2)	400 V
Rated surge voltage (II/2)	4 kV
minimum clearance value - non-homogenous field (II/2)	3 mm
minimum creepage distance (II/2)	4 mm

Environmental and real-life conditions

Vibration test

Specification	IEC 60068-2-6:2007-12
Frequency	10 - 150 - 10 Hz
Sweep speed	1 octave/min
Amplitude	0.35 mm (10 Hz ... 60.1 Hz)
Sweep speed	5g (60.1 Hz ... 150 Hz)
Test duration per axis	2.5 h

Durability test

Specification	IEC 60512-9-1:2010-03
Impulse withstand voltage at sea level	4.8 kV
Contact resistance R_1	1.2 m Ω
Contact resistance R_2	1.2 m Ω
Insertion/withdrawal cycles	25
Insulation resistance, neighboring positions	> 5 M Ω

Climatic test

Specification	ISO 6988:1985-02
Corrosive stress	0.2 dm ³ SO ₂ on 300 dm ³ /40 °C/1 cycle
Thermal stress	100 °C/168 h
Power-frequency withstand voltage	2.21 kV

Ambient conditions

Ambient temperature (operation)	-40 °C ... 100 °C (dependent on the derating curve)
Ambient temperature (storage/transport)	-40 °C ... 70 °C
Relative humidity (storage/transport)	30 % ... 70 %
Ambient temperature (assembly)	-5 °C ... 100 °C

Packaging specifications

Type of packaging	packed in cardboard
-------------------	---------------------

1955471

<https://www.phoenixcontact.com/de/produkte/1955471>

Drawings

Diagram

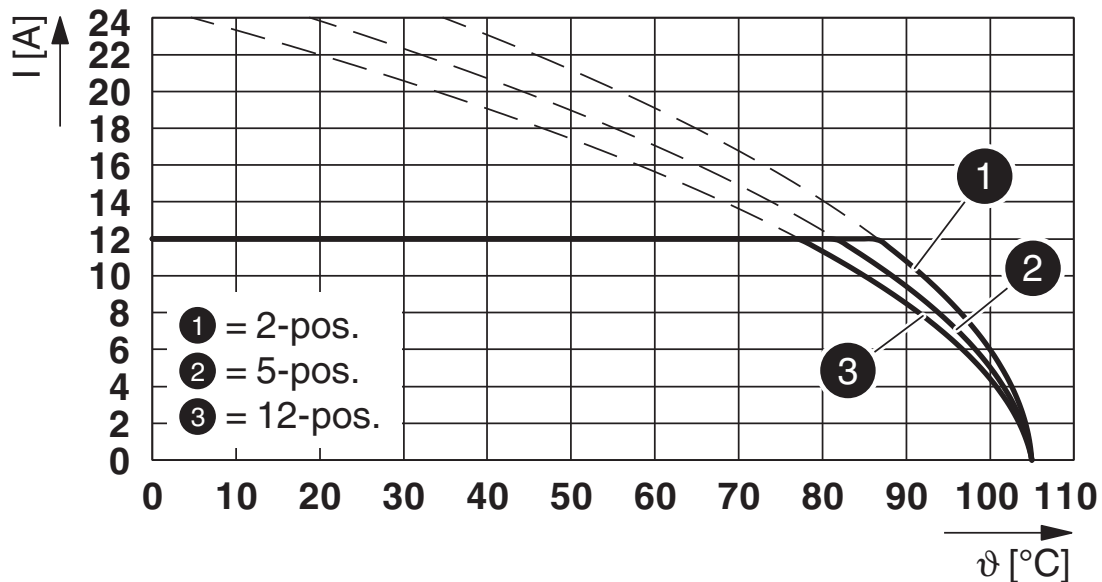

Type: FKCN 2,5/...-ST-5,08 with CCV 2,5/...-G-5,08 P...THR

Drilling plan/solder pad geometry

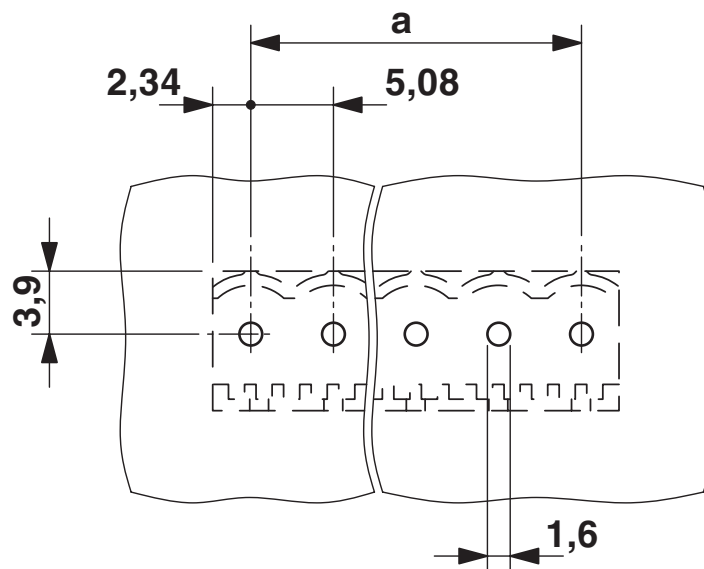

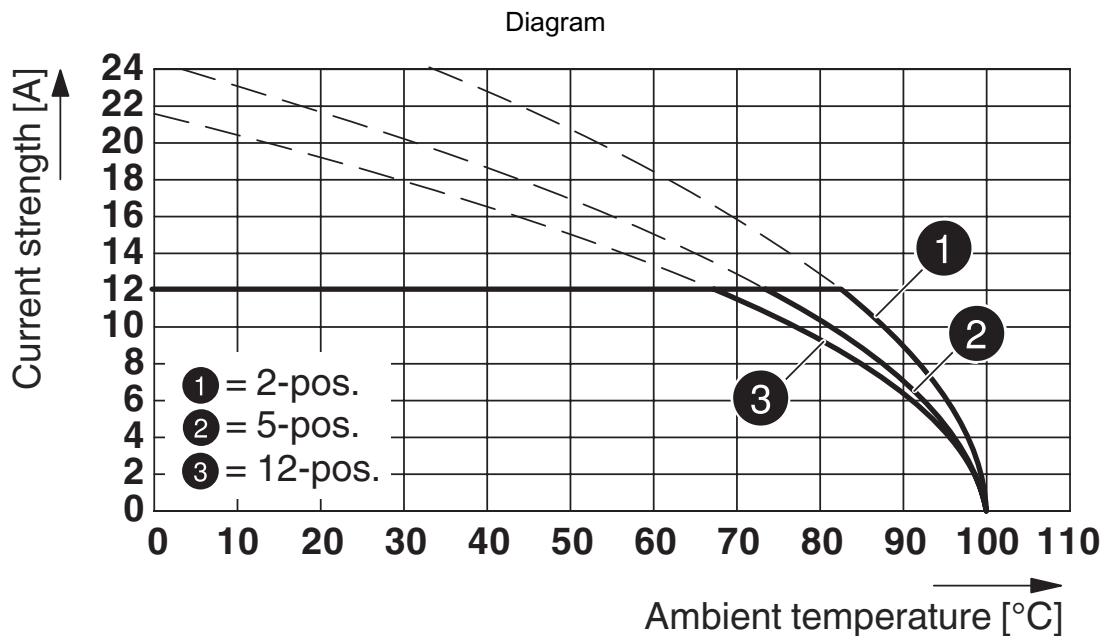

Type: MSTBT 2,5/...-ST-5,08 with CCV 2,5/...-G-5,08 P26THR

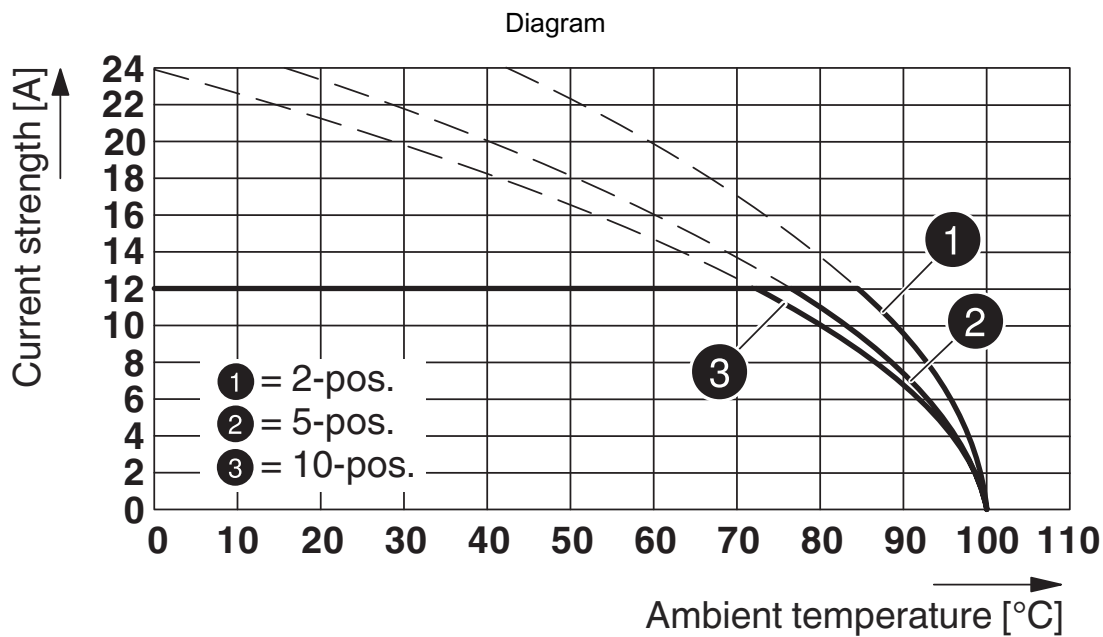

Type: TVMSTB 2,5/...-ST-5,08 with CCV 2,5/...-G-5,08 P26THR

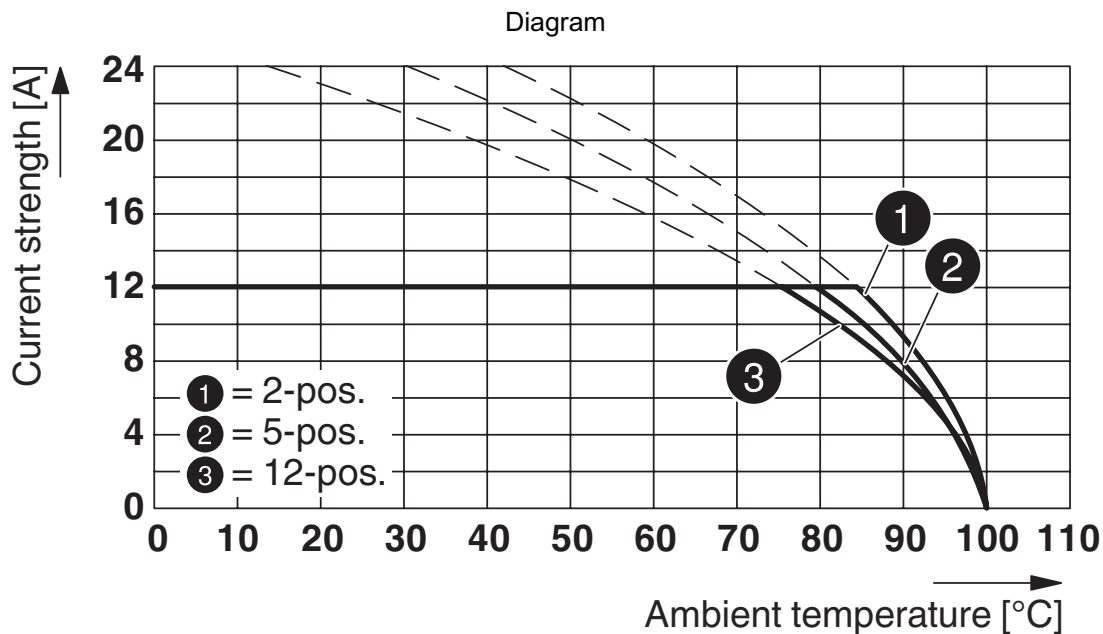

Type: FKC 2,5/...-ST-5,08 with CCV 2,5/...-G-5,08 P26THR

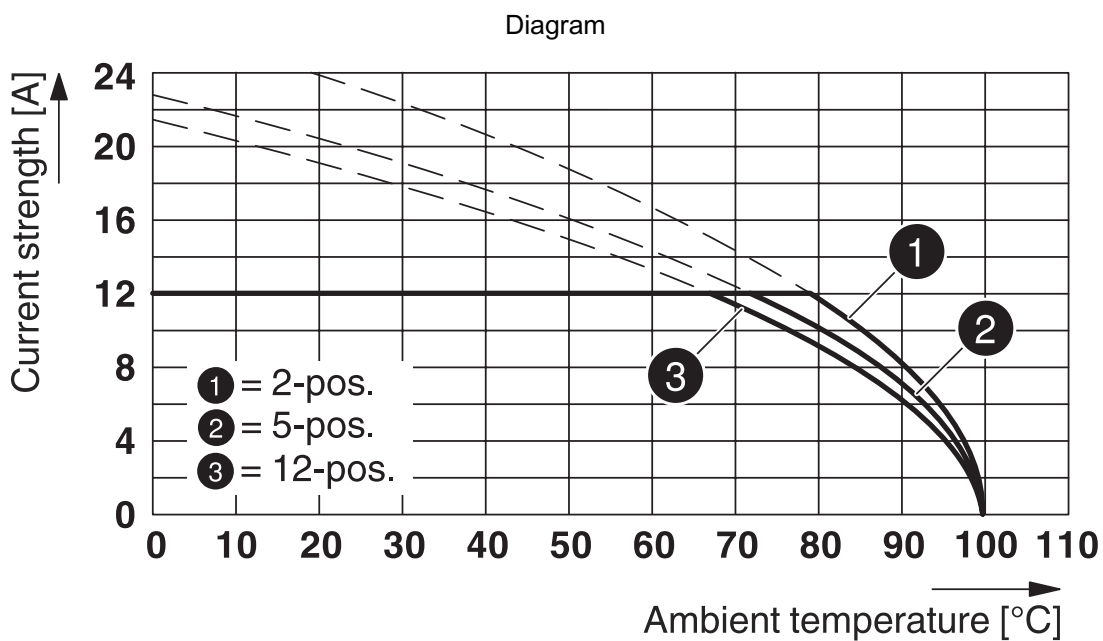

Type: MSTB 2,5/...-ST-5,08 with CCV 2,5/...-G-5,08 P26THR

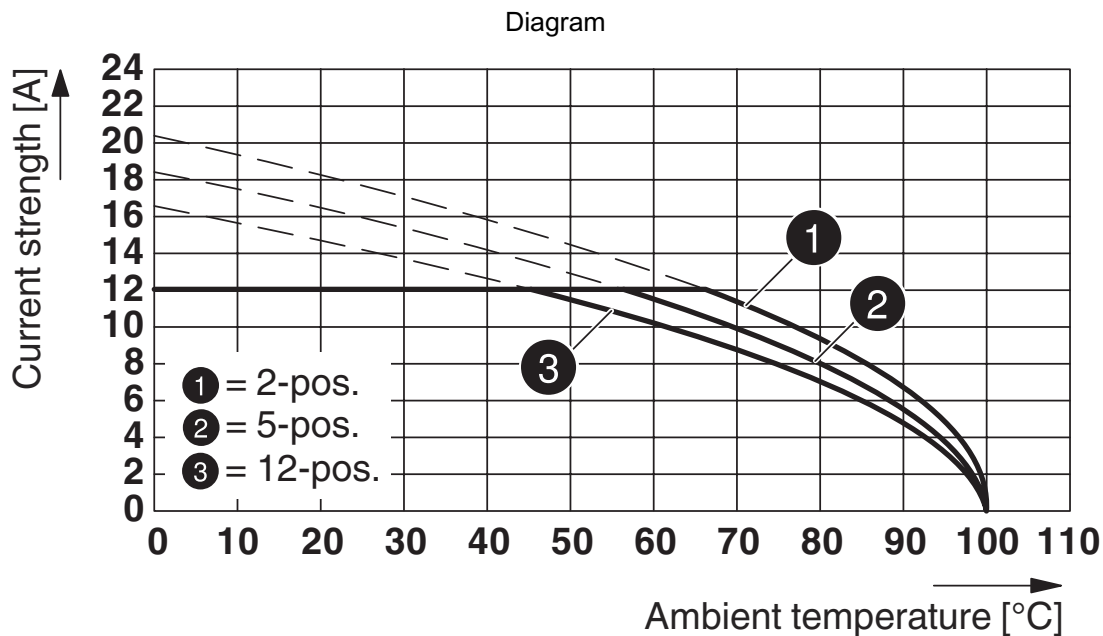

Type: SMSTB 2,5/...-ST-5,08 with CCV 2,5/...-G-5,08 P26THR

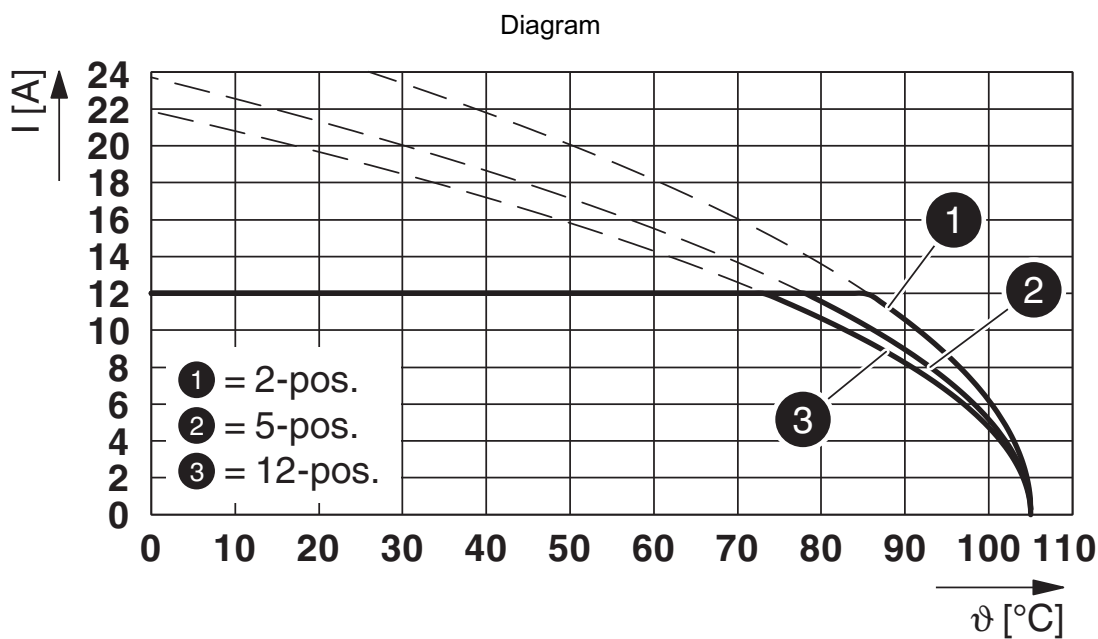

Type: FKCVW 2,5/...-ST-5,08 with CCV 2,5/...-G-5,08 P26THR

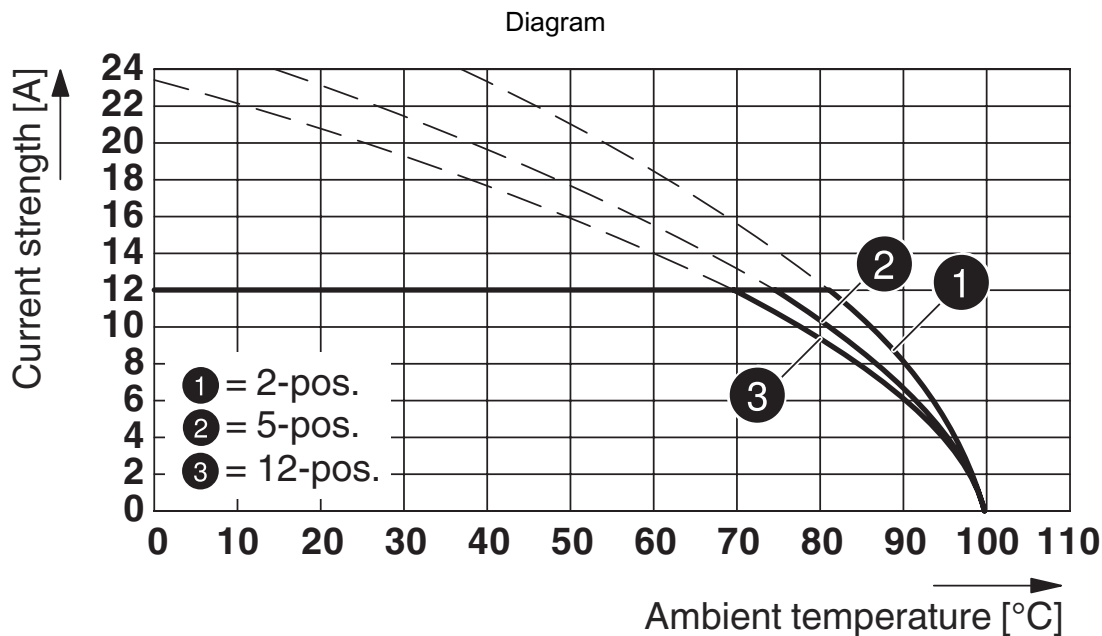

Type: MSTBP 2,5/...-ST-5,08 with CCV 2,5/...-G-5,08 P26THR

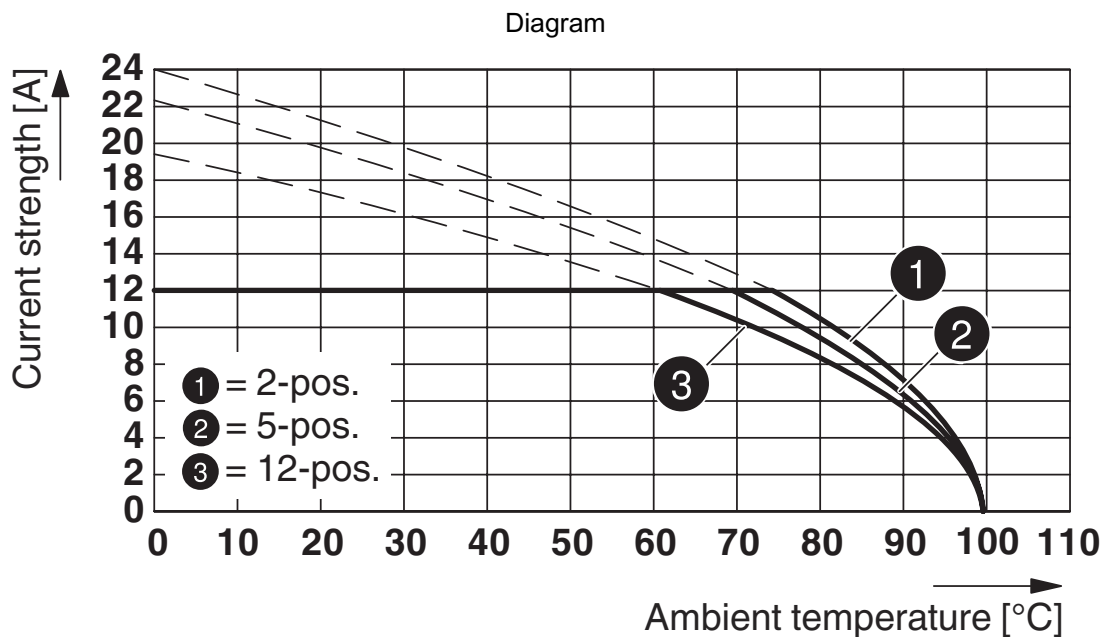

Type: FRONT-MSTB 2,5/...-ST-5,08 with CCV 2,5/...-G-5,08 P26THR

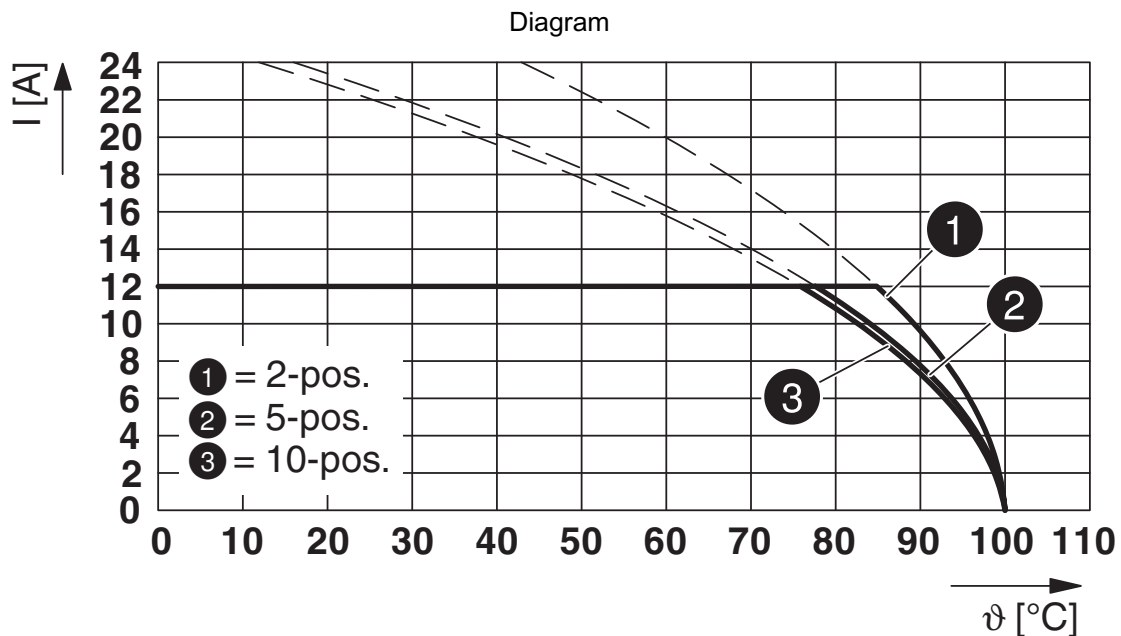

Type: TFKC 2,5/...-ST-5,08 with CCV 2,5/...-G-5,08 P...THR

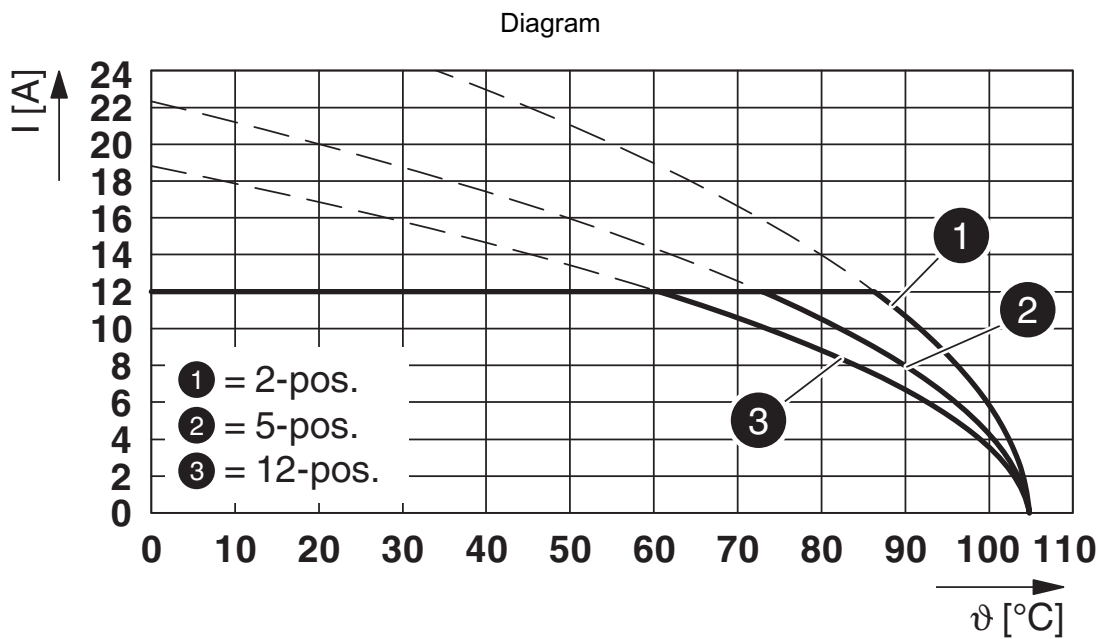

Type: ICV 2,5/...-G-5,08 with CCV 2,5/...-G-5,08 P...THR

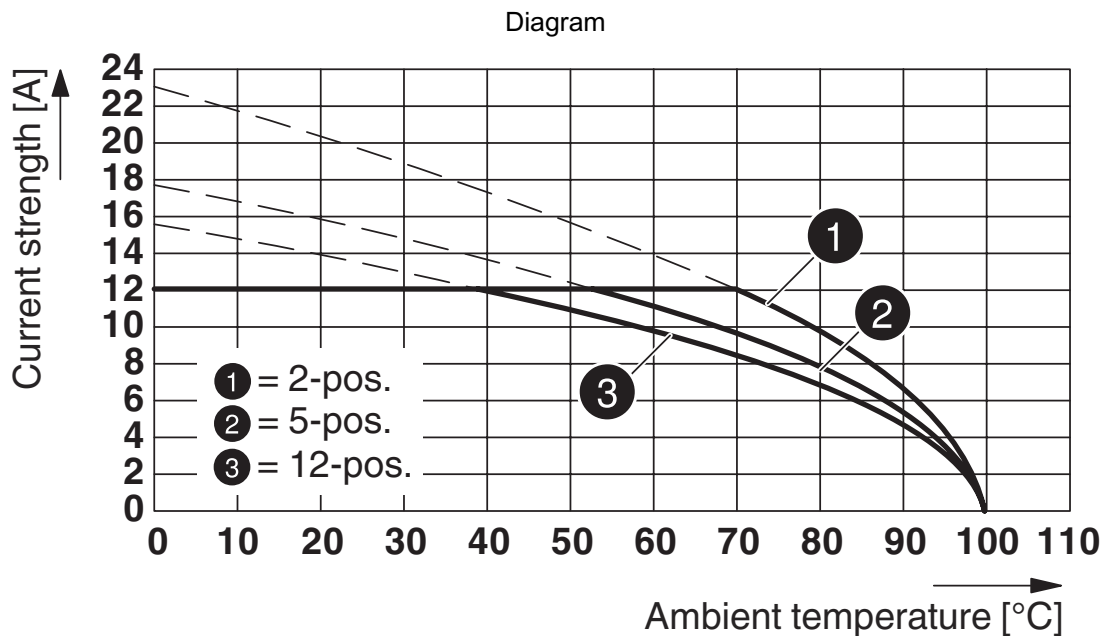

Type: MVSTBR 2,5/...-ST-5,08 with CCV 2,5/...-G-5,08 P26THR

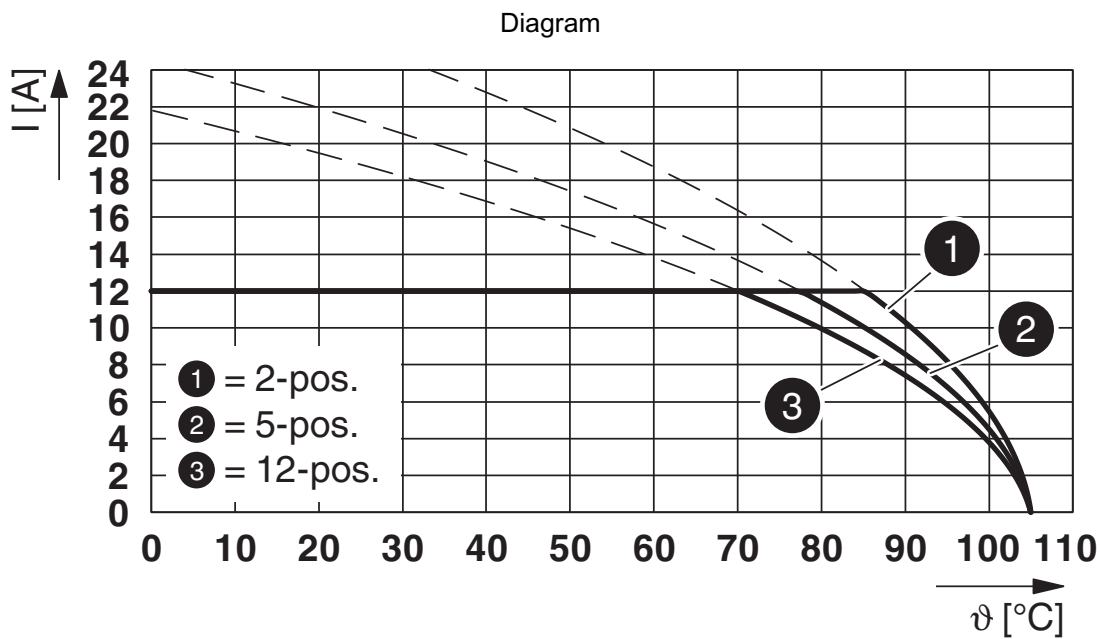

Type: FKCT 2,5/...-ST-5,08 with CCV 2,5/...-G-5,08 P...THR

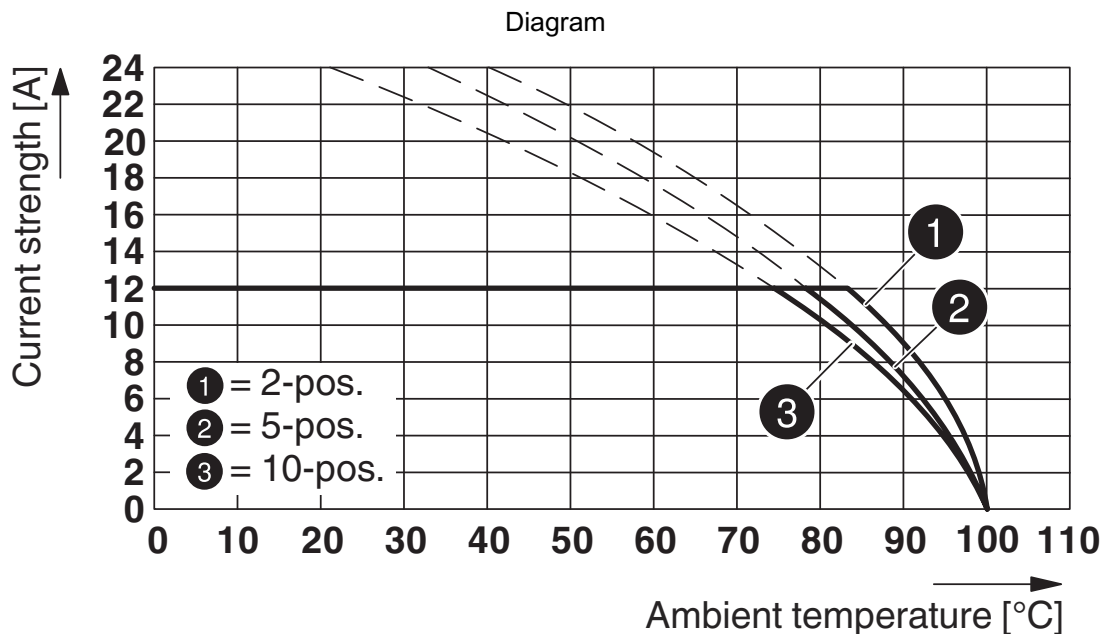

Type: TMSTBP 2,5/...-ST-5,08 with CCV 2,5/...-G-5,08 P26THR

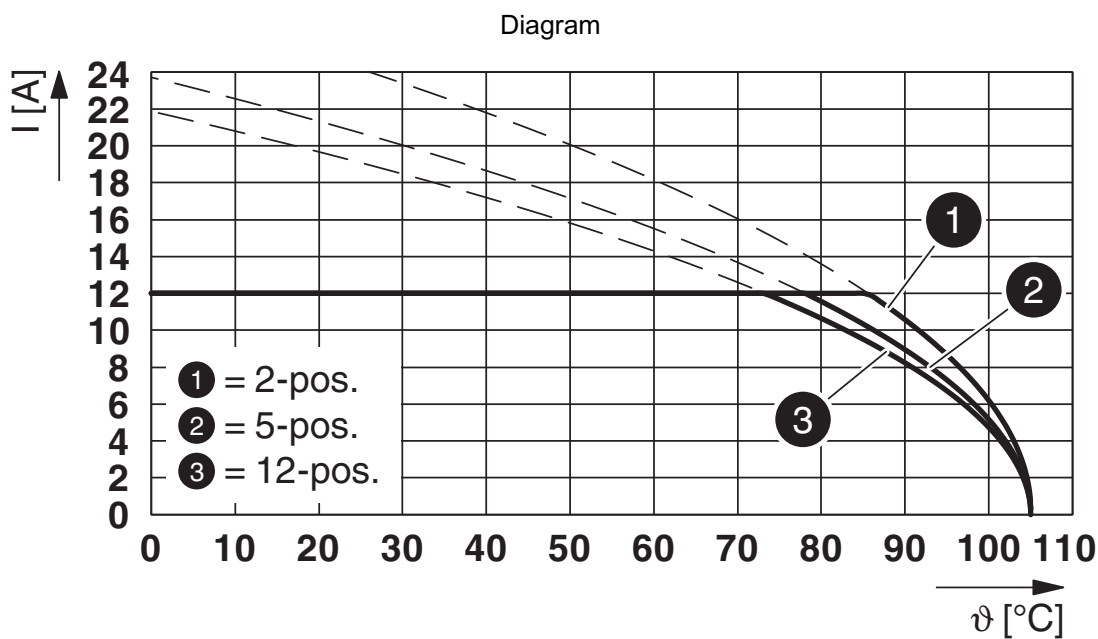

Type: FKCVR 2,5/...-ST-5,08 with CCV 2,5/...-G-5,08 P26THR

CCV 2,5/ 8-G-5,08 P26THR - PCB header





1955471

<https://www.phoenixcontact.com/de/produkte/1955471>

Approvals

 IECEE CB Scheme Approval ID: DE1-58421-B1B2				
	Nominal Voltage U_N	Nominal Current I_N	Cross Section AWG	Cross Section mm^2
	400 V	12 A	-	-

 EAC Approval ID: B.01687				
--	--	--	--	--

 cULus Recognized Approval ID: E60425-19931011				
	Nominal Voltage U_N	Nominal Current I_N	Cross Section AWG	Cross Section mm^2
Use group B				
Standard	300 V	16 A	-	-
Use group D				
Standard	300 V	10 A	-	-
Alternative 1	150 V	15 A	-	-

 VDE Gutachten mit Fertigungsüberwachung Approval ID: 40041286				
	Nominal Voltage U_N	Nominal Current I_N	Cross Section AWG	Cross Section mm^2
	400 V	12 A	-	-

1955471

<https://www.phoenixcontact.com/de/produkte/1955471>

Classifications

ECLASS

ECLASS-9.0	27440402
ECLASS-10.0.1	27440402
ECLASS-11.0	27460201

ETIM

ETIM 8.0	EC002637
----------	----------

UNSPSC

UNSPSC 21.0	39121400
-------------	----------

CCV 2,5/ 8-G-5,08 P26THR - PCB header



1955471

<https://www.phoenixcontact.com/de/produkte/1955471>

Environmental Product Compliance

China RoHS	Environmentally friendly use period: unlimited = EFUP-e
	No hazardous substances above threshold values

CCV 2,5/ 8-G-5,08 P26THR - PCB header

1955471

<https://www.phoenixcontact.com/de/produkte/1955471>

Accessories

CR-MSTB - Coding section

1734401

<https://www.phoenixcontact.com/de/produkte/1734401>

Coding section, inserted into the recess in the header or the inverted plug, red insulating material



CR-MSTB NAT HT - Coding section

1954362

<https://www.phoenixcontact.com/de/produkte/1954362>

HT coding section, prior to the reflow soldering process it is inserted into the recess on the header, made from high-temperature-resistant beige insulation material



CCV 2,5/ 8-G-5,08 P26THR - PCB header

1955471

<https://www.phoenixcontact.com/de/produkte/1955471>



SK 5,08/3,8:FORTL.ZAHLEN - Marker card

0804293

<https://www.phoenixcontact.com/de/produkte/0804293>



Marker card, white, labeled, horizontal: consecutive numbers 1 ... 10, 11 ... 20, etc. up to 91 ... (99)100, mounting type: adhesive, for terminal block width: 5.08 mm, lettering field size: 5.08 x 3.8 mm

B-STIFT - Marker pen

1051993

<https://www.phoenixcontact.com/de/produkte/1051993>



Marker pen, for manual labeling of unprinted Zack strips, smear-proof and waterproof, line thickness 0.5 mm

CCV 2,5/ 8-G-5,08 P26THR - PCB header

1955471

<https://www.phoenixcontact.com/de/produkte/1955471>

TVMSTB 2,5/ 8-ST-5,08 - PCB connector

1719066

<https://www.phoenixcontact.com/de/produkte/1719066>



PCB connector, nominal cross section: 2.5 mm², color: green, nominal current: 12 A, rated voltage (III/2): 400 V, contact surface: Tin, type of contact: Female connector, number of potentials: 8, number of rows: 1, number of positions: 8, number of connections: 16, product range: TVMSTB 2,5/..-ST, pitch: 5.08 mm, connection method: Screw connection with tension sleeve, screw head form: L Slotted, conductor/PCB connection direction: 90 °, locking clip: - Locking clip, plug-in system: COMBICON MSTB 2,5, locking: without, mounting: without, type of packaging: packed in cardboard

FKCN 2,5/ 8-ST-5,08 - PCB connector

1754623

<https://www.phoenixcontact.com/de/produkte/1754623>



PCB connector, nominal cross section: 2.5 mm², color: green, nominal current: 12 A, rated voltage (III/2): 320 V, contact surface: Tin, type of contact: Female connector, number of potentials: 8, number of rows: 1, number of positions: 8, number of connections: 8, product range: FKCN 2,5/..-ST, pitch: 5.08 mm, connection method: Push-in spring connection, conductor/PCB connection direction: 0 °, locking clip: - Locking clip, plug-in system: COMBICON MSTB 2,5, locking: without, mounting: without, type of packaging: packed in cardboard

CCV 2,5/ 8-G-5,08 P26THR - PCB header

1955471

<https://www.phoenixcontact.com/de/produkte/1955471>

MSTB 2,5/ 8-ST-5,08 - PCB connector

1757077

<https://www.phoenixcontact.com/de/produkte/1757077>



PCB connector, nominal cross section: 2.5 mm², color: green, nominal current: 12 A, rated voltage (III/2): 320 V, contact surface: Tin, type of contact: Female connector, number of potentials: 8, number of rows: 1, number of positions: 8, number of connections: 8, product range: MSTB 2,5/...-ST, pitch: 5.08 mm, connection method: Screw connection with tension sleeve, screw head form: L Slotted, conductor/PCB connection direction: 0 °, locking clip: - Locking clip, plug-in system: COMBICON MSTB 2,5, locking: without, mounting: without, type of packaging: packed in cardboard

MSTB 2,5/ 8-STZ-5,08 - PCB connector

1764235

<https://www.phoenixcontact.com/de/produkte/1764235>



PCB connector, nominal cross section: 2.5 mm², color: green, nominal current: 12 A, rated voltage (III/2): 320 V, contact surface: Tin, type of contact: Female connector, number of potentials: 8, number of rows: 1, number of positions: 8, number of connections: 8, product range: MSTB 2,5/...-STZ, pitch: 5.08 mm, connection method: Screw connection with tension sleeve, screw head form: L Slotted, conductor/PCB connection direction: 0 °, locking clip: - Locking clip, plug-in system: COMBICON MSTB 2,5, locking: without, mounting: without, type of packaging: packed in cardboard

CCV 2,5/ 8-G-5,08 P26THR - PCB header

1955471

<https://www.phoenixcontact.com/de/produkte/1955471>

MSTBP 2,5/ 8-ST-5,08 - PCB connector

1769078

<https://www.phoenixcontact.com/de/produkte/1769078>



PCB connector, nominal cross section: 2.5 mm², color: green, nominal current: 12 A, rated voltage (III/2): 320 V, contact surface: Tin, type of contact: Female connector, number of potentials: 8, number of rows: 1, number of positions: 8, number of connections: 8, product range: MSTBP 2,5/..-ST, pitch: 5.08 mm, connection method: Screw connection with tension sleeve, screw head form: L Slotted, conductor/PCB connection direction: 0 °, locking clip: - Locking clip, plug-in system: COMBICON MSTB 2,5, locking: without, mounting: without, type of packaging: packed in cardboard

FRONT-MSTB 2,5/ 8-ST-5,08 - PCB connector

1777345

<https://www.phoenixcontact.com/de/produkte/1777345>



PCB connector, nominal cross section: 2.5 mm², color: green, nominal current: 12 A, rated voltage (III/2): 320 V, contact surface: Tin, type of contact: Female connector, number of potentials: 8, number of rows: 1, number of positions: 8, number of connections: 8, product range: FRONT-MSTB 2,5/..-ST, pitch: 5.08 mm, connection method: Front screw connection, screw head form: L Slotted, conductor/PCB connection direction: 0 °, locking clip: - Locking clip, plug-in system: COMBICON MSTB 2,5, locking: without, mounting: without, type of packaging: packed in cardboard

CCV 2,5/ 8-G-5,08 P26THR - PCB header

1955471

<https://www.phoenixcontact.com/de/produkte/1955471>

MSTBT 2,5/ 8-ST-5,08 - PCB connector

1781043

<https://www.phoenixcontact.com/de/produkte/1781043>



PCB connector, nominal cross section: 2.5 mm², color: green, nominal current: 12 A, rated voltage (III/2): 320 V, contact surface: Tin, type of contact: Female connector, number of potentials: 8, number of rows: 1, number of positions: 8, number of connections: 8, product range: MSTBT 2,5/..-ST, pitch: 5.08 mm, connection method: Screw connection with tension sleeve, screw head form: L Slotted, conductor/PCB connection direction: 0 °, locking clip: - Locking clip, plug-in system: COMBICON MSTB 2,5, locking: without, mounting: without, type of packaging: packed in cardboard

MVSTBR 2,5/ 8-ST-5,08 - PCB connector

1792304

<https://www.phoenixcontact.com/de/produkte/1792304>



PCB connector, nominal cross section: 2.5 mm², color: green, nominal current: 12 A, rated voltage (III/2): 320 V, contact surface: Tin, type of contact: Female connector, number of potentials: 8, number of rows: 1, number of positions: 8, number of connections: 8, product range: MVSTBR 2,5/..-ST, pitch: 5.08 mm, connection method: Screw connection with tension sleeve, screw head form: L Slotted, conductor/PCB connection direction: 90 °, locking clip: - Locking clip, plug-in system: COMBICON MSTB 2,5, locking: without, mounting: without, type of packaging: packed in cardboard

CCV 2,5/ 8-G-5,08 P26THR - PCB header

1955471

<https://www.phoenixcontact.com/de/produkte/1955471>

MVSTBW 2,5/ 8-ST-5,08 - PCB connector

1792812

<https://www.phoenixcontact.com/de/produkte/1792812>



PCB connector, nominal cross section: 2.5 mm², color: green, nominal current: 12 A, rated voltage (III/2): 320 V, contact surface: Tin, type of contact: Female connector, number of potentials: 8, number of rows: 1, number of positions: 8, number of connections: 8, product range: MVSTBW 2,5/..-ST, pitch: 5.08 mm, connection method: Screw connection with tension sleeve, screw head form: L Slotted, conductor/PCB connection direction: -90 °, locking clip: - Locking clip, plug-in system: COMBICON MSTB 2,5, locking: without, mounting: without, type of packaging: packed in cardboard

MSTBC 2,5/ 8-ST-5,08 - PCB connector

1808874

<https://www.phoenixcontact.com/de/produkte/1808874>



PCB connector, nominal cross section: 2.5 mm², color: green, nominal current: 12 A, rated voltage (III/2): 320 V, type of contact: Female connector, number of potentials: 8, number of rows: 1, number of positions: 8, number of connections: 8, product range: MSTBC 2,5/..-ST, pitch: 5.08 mm, connection method: Crimp connection, conductor/PCB connection direction: 0 °, locking clip: - Locking clip, plug-in system: COMBICON MSTB 2,5, locking: without, mounting: without, type of packaging: packed in cardboard, Corresponding female crimp contacts with current [A] and conductor cross section range [mm²] data: 10A/MSTBC-MT 0,5-1,0 (3190564); 10A/MSTBC-MT 0,5-1,0 BA (3190645); 12A/MSTBC-MT 1,5-2,5 (3190551); 12A/MSTBC-MT 1,5-2,5 BA (3190658). BA = Bandkontakte

CCV 2,5/ 8-G-5,08 P26THR - PCB header

1955471

<https://www.phoenixcontact.com/de/produkte/1955471>

MSTBC 2,5/ 8-STZ-5,08 - PCB connector

1809569

<https://www.phoenixcontact.com/de/produkte/1809569>



PCB connector, nominal cross section: 2.5 mm², color: green, nominal current: 12 A, rated voltage (III/2): 320 V, type of contact: Female connector, number of potentials: 8, number of rows: 1, number of positions: 8, number of connections: 8, product range: MSTBC 2,5/...-STZ, pitch: 5.08 mm, connection method: Crimp connection, conductor/PCB connection direction: 0 °, locking clip: - Locking clip, plug-in system: COMBICON MSTB 2,5, locking: without, mounting: without, type of packaging: packed in cardboard, Corresponding female crimp contacts with current [A] and conductor cross section range [mm²] data: 10A/MSTBC-MT 0,5-1,0 (3190564); 10A/MSTBC-MT 0,5-1,0 BA (3190645); 12A/MSTBC-MT 1,5-2,5 (3190551); 12A/MSTBC-MT 1,5-2,5 BA (3190658). BA = Bandkontakte

MSTBU 2,5/ 8-STD-5,08 - Printed-circuit board connector

1824188

<https://www.phoenixcontact.com/de/produkte/1824188>



Direct plug-in block, nominal cross section: 2.5 mm², color: green, nominal current: 12 A, rated voltage (III/2): 320 V, contact surface: Tin, type of contact: Female connector, number of potentials: 8, number of rows: 1, number of positions: 8, number of connections: 8, product range: MSTBU 2,5/...-STD, pitch: 5.08 mm, connection method: Screw connection with tension sleeve, screw head form: L Slotted, mounting: Direct mounting, conductor/PCB connection direction: 0 °, plug-in system: COMBICON MSTB 2,5, locking: without, mounting: without, type of packaging: packed in cardboard

CCV 2,5/ 8-G-5,08 P26THR - PCB header

1955471

<https://www.phoenixcontact.com/de/produkte/1955471>

MSTBVK 2,5/ 8-ST-5,08 - DIN rail connector

1831375

<https://www.phoenixcontact.com/de/produkte/1831375>



DIN rail connector, nominal cross section: 2.5 mm², color: green, nominal current: 12 A, rated voltage (III/2): 320 V, contact surface: Tin, type of contact: Female connector, number of potentials: 8, number of rows: 1, number of positions: 8, number of connections: 8, product range: MSTBVK 2,5/...-ST, pitch: 5.08 mm, connection method: Screw connection with tension sleeve, screw head form: L Slotted, mounting: DIN rail, conductor/PCB connection direction: 0 °, plug-in system: COMBICON MSTB 2,5, locking: without, mounting: without, type of packaging: packed in cardboard

UMSTBVK 2,5/ 8-ST-5,08 - DIN rail connector

1833878

<https://www.phoenixcontact.com/de/produkte/1833878>



DIN rail connector, nominal cross section: 2.5 mm², color: green, nominal current: 12 A, rated voltage (III/2): 320 V, contact surface: Tin, type of contact: Female connector, number of potentials: 8, number of rows: 1, number of positions: 8, number of connections: 8, product range: UMSTBVK 2,5/...-ST, pitch: 5.08 mm, connection method: Screw connection with tension sleeve, screw head form: L Slotted, mounting: DIN rail, conductor/PCB connection direction: 0 °, plug-in system: COMBICON MSTB 2,5, locking: without, mounting: without, type of packaging: packed in cardboard

CCV 2,5/ 8-G-5,08 P26THR - PCB header

1955471

<https://www.phoenixcontact.com/de/produkte/1955471>

TMSTBP 2,5/ 8-ST-5,08 - PCB connector

1853078

<https://www.phoenixcontact.com/de/produkte/1853078>



PCB connector, nominal cross section: 2.5 mm², color: green, nominal current: 12 A, rated voltage (III/2): 320 V, contact surface: Tin, type of contact: Female connector, number of potentials: 8, number of rows: 1, number of positions: 8, number of connections: 16, product range: TMSTBP 2,5/..-ST, pitch: 5.08 mm, connection method: Screw connection with tension sleeve, screw head form: L Slotted, conductor/PCB connection direction: 0 °, locking clip: - Locking clip, plug-in system: COMBICON MSTB 2,5, locking: without, mounting: without, type of packaging: packed in cardboard, The plug allows conductors to be looped through from module to module.

FKC 2,5/ 8-ST-5,08 - PCB connector

1873113

<https://www.phoenixcontact.com/de/produkte/1873113>

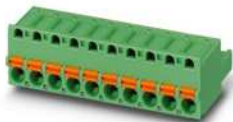

PCB connector, nominal cross section: 2.5 mm², color: green, nominal current: 12 A, rated voltage (III/2): 320 V, contact surface: Tin, type of contact: Female connector, number of potentials: 8, number of rows: 1, number of positions: 8, number of connections: 8, product range: FKC 2,5/..-ST, pitch: 5.08 mm, connection method: Push-in spring connection, conductor/PCB connection direction: 0 °, locking clip: - Locking clip, plug-in system: COMBICON MSTB 2,5, locking: without, mounting: without, type of packaging: packed in cardboard

CCV 2,5/ 8-G-5,08 P26THR - PCB header

1955471

<https://www.phoenixcontact.com/de/produkte/1955471>



FKCVW 2,5/ 8-ST-5,08 - PCB connector

1873715

<https://www.phoenixcontact.com/de/produkte/1873715>



PCB connector, nominal cross section: 2.5 mm², color: green, nominal current: 12 A, rated voltage (III/2): 320 V, contact surface: Tin, type of contact: Female connector, number of potentials: 8, number of rows: 1, number of positions: 8, number of connections: 8, product range: FKCVW 2,5/..-ST, pitch: 5.08 mm, connection method: Push-in spring connection, conductor/PCB connection direction: -90 °, locking clip: - Locking clip, plug-in system: COMBICON MSTB 2,5, locking: without, mounting: without, type of packaging: packed in cardboard

FKCVR 2,5/ 8-ST-5,08 - PCB connector

1874015

<https://www.phoenixcontact.com/de/produkte/1874015>



PCB connector, nominal cross section: 2.5 mm², color: green, nominal current: 12 A, rated voltage (III/2): 320 V, contact surface: Tin, type of contact: Female connector, number of potentials: 8, number of rows: 1, number of positions: 8, number of connections: 8, product range: FKCVR 2,5/..-ST, pitch: 5.08 mm, connection method: Push-in spring connection, conductor/PCB connection direction: 90 °, locking clip: - Locking clip, plug-in system: COMBICON MSTB 2,5, locking: without, mounting: without, type of packaging: packed in cardboard

CCV 2,5/ 8-G-5,08 P26THR - PCB header

1955471

<https://www.phoenixcontact.com/de/produkte/1955471>

QC 1/ 8-ST-5,08 - PCB connector

1883310

<https://www.phoenixcontact.com/de/produkte/1883310>

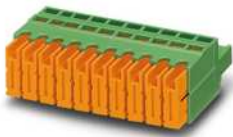

PCB connector, nominal cross section: 1 mm², color: green, nominal current: 10 A, rated voltage (III/2): 630 V, contact surface: Tin, type of contact: Female connector, number of potentials: 8, number of rows: 1, number of positions: 8, number of connections: 8, product range: QC 1/..-ST, pitch: 5.08 mm, connection method: Displacement connection, conductor/PCB connection direction: 0 °, locking clip: - Locking clip, plug-in system: COMBICON MSTB 2,5, locking: without, mounting: without, type of packaging: packed in cardboard

FKCT 2,5/ 8-ST-5,08 - PCB connector

1902178

<https://www.phoenixcontact.com/de/produkte/1902178>



PCB connector, nominal cross section: 2.5 mm², color: green, nominal current: 12 A, rated voltage (III/2): 320 V, contact surface: Tin, type of contact: Female connector, number of potentials: 8, number of rows: 1, number of positions: 8, number of connections: 8, product range: FKCT 2,5/..-ST, pitch: 5.08 mm, connection method: Push-in spring connection, conductor/PCB connection direction: 0 °, locking clip: - Locking clip, plug-in system: COMBICON MSTB 2,5, locking: without, mounting: without, type of packaging: packed in cardboard

CCV 2,5/ 8-G-5,08 P26THR - PCB header

1955471

<https://www.phoenixcontact.com/de/produkte/1955471>



TFKC 2,5/ 8-ST-5,08 - PCB connector

1962668

<https://www.phoenixcontact.com/de/produkte/1962668>

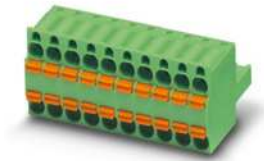

PCB connector, nominal cross section: 2.5 mm², color: green, nominal current: 12 A, rated voltage (III/2): 320 V, contact surface: Tin, type of contact: Female connector, number of potentials: 8, number of rows: 1, number of positions: 8, number of connections: 16, product range: TFKC 2,5/..-ST, pitch: 5.08 mm, connection method: Push-in spring connection, conductor/PCB connection direction: 0 °, locking clip: - Locking clip, plug-in system: COMBICON MSTB 2,5, locking: without, mounting: without, type of packaging: packed in cardboard

FKCS 2,5/ 8-ST-5,08 - PCB connector

1975134

<https://www.phoenixcontact.com/de/produkte/1975134>



PCB connector, nominal cross section: 2.5 mm², color: green, nominal current: 12 A, rated voltage (III/2): 320 V, contact surface: Tin, type of contact: Female connector, number of potentials: 8, number of rows: 1, number of positions: 8, number of connections: 8, product range: FKCS 2,5/..-ST, pitch: 5.08 mm, connection method: Push-in spring connection, conductor/PCB connection direction: 0 °, locking clip: - Locking clip, plug-in system: COMBICON MSTB 2,5, locking: without, mounting: without, type of packaging: packed in cardboard

Phoenix Contact 2023 © - all rights reserved
<https://www.phoenixcontact.com>

PHOENIX CONTACT Deutschland GmbH
Flachsmarktstraße 8
D-32825 Blomberg
+49 52 35/3-1 20 00
info@phoenixcontact.de