

PLEASE CHECK WWW.MOLEX.COM FOR LATEST PART INFORMATION

Part Number: [19427-0017](#)
Status: **Active**
Overview: MX150L™ Sealed Connector System
Description: 5.84mm Pitch MX150L™ Right Angle PCB Header, Dual Row, without PCB Flange, 8 Circuits

Documents:

[3D Model](#) [RoHS Certificate of Compliance \(PDF\)](#)
[Drawing \(PDF\)](#) [Product Literature \(PDF\)](#)
[Product Specification PS-19427-001 \(PDF\)](#)

Agency Certification

UL E152602

General

Product Family PCB Headers
 Series [19427](#)
 Application Power, Wire-to-Board
 Comments IP67 rated; conforms to UL 1977. NOT suitable for automotive applications with requirements such as USCAR-2, USCAR-25, GMW3191, AK Testing, J2030, Volvo Technology Requirements, and Toyota Connector Spec (TCS)
 Overview [MX150L™ Sealed Connector System](#)
 Product Literature Order No 987650-2181
 Product Name MX150L™
 UPC 822348739998

Physical

Breakaway No
 Circuits (Loaded) 8
 Circuits (maximum) 8
 Durability (mating cycles max) 25
 Flammability 94V-0
 Glow-Wire Compliant No
 Lock to Mating Part Yes
 Material - Plating Mating Tin
 Material - Plating Termination Tin
 Net Weight 62.336/g
 Number of Rows 2
 Orientation Right Angle
 PC Tail Length 3.30mm
 PCB Locator Yes
 PCB Retention None
 PCB Thickness - Recommended 1.60mm
 Packaging Type Tray
 Pitch - Mating Interface 5.84mm
 Polarized to Mating Part Yes
 Polarized to PCB No
 Shrouded Fully
 Stackable No
 Surface Mount Compatible (SMC) No
 Temperature Range - Operating -40°C to +125°C
 Termination Interface: Style Through Hole

Electrical

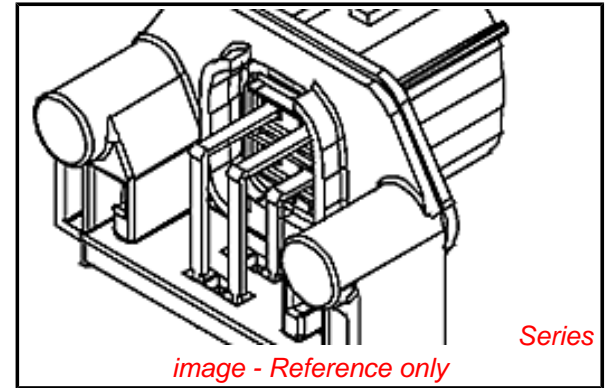

EU RoHS

ELV and RoHS Compliant
REACH SVHC
 Not Reviewed
Low-Halogen Status
 Not Reviewed

China RoHS



Need more information on product environmental compliance?

Email productcompliance@molex.com
 For a multiple part number RoHS Certificate of Compliance, [click here](#)

Please visit the [Contact Us](#) section for any non-product compliance questions.

Search Parts in this Series

[19427Series](#)

Mates With

[19418 Receptacle Assemblies](#)

Current - Maximum per Contact	18A
Voltage - Maximum	600V

Material Info

Reference - Drawing Numbers

Product Specification	PS-19427-001
Sales Drawing	SD-19427-022

This document was generated on 11/14/2012

PLEASE CHECK WWW.MOLEX.COM FOR LATEST PART INFORMATION