

PLEASE CHECK WWW.MOLEX.COM FOR LATEST PART INFORMATION

Part Number: [19419-0020](#)
Status: **Active**
Overview: [MX150L™ Sealed Connector System](#)
Description: [MX150L™ 16 Circuit Plug for 18-22 AWG Wire](#)

Documents:

3D Model	Application Specification AS-19417-001 (PDF)
Drawing (PDF)	RoHS Certificate of Compliance (PDF)
Product Specification PS-19417-001 (PDF)	Product Literature (PDF)

Agency Certification

CSA	LR18689
UL	E152602

General

Product Family	Crimp Housings
Series	19419
Application	Power, Wire-to-Wire
Comments	IP67 rated; conforms to UL 1977. NOT suitable for automotive applications with requirements such as USCAR-2, USCAR-25, GMW3191, AK Testing, J2030, Volvo Technology Requirements, and Toyota Connector Spec (TCS)
Overview	MX150L™ Sealed Connector System
Product Literature Order No	987650-2181
Product Name	MX150L™
UPC	822348526628

Physical

Circuits (maximum)	16
Flammability	94V-0
Gender	Male
Glow-Wire Compliant	No
Lock to Mating Part	Yes
Net Weight	31.916/g
Number of Rows	2
Packaging Type	Bag
Panel Mount	No
Pitch - Mating Interface	5.84mm
Polarized to Mating Part	Yes
Stackable	No
Temperature Range - Operating	-40°C to +125°C

Electrical

Current - Maximum per Contact	18A
-------------------------------	-----

Material Info

Reference - Drawing Numbers

Application Specification	AS-19417-001
Product Specification	PS-19417-001
Sales Drawing	SD-19419-007

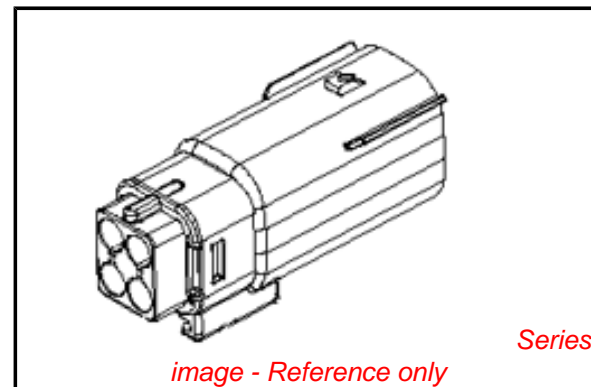

EU RoHS

ELV and RoHS Compliant
REACH SVHC
 Not Reviewed
Low-Halogen Status
 Not Reviewed

China RoHS



Need more information on product environmental compliance?

Email productcompliance@molex.com
 For a multiple part number RoHS Certificate of Compliance, [click here](#)

Please visit the [Contact Us](#) section for any non-product compliance questions.

Search Parts in this Series

[19419Series](#)

Mates With

[19418 Receptacle Assemblies](#)

Use With

[19417 Male Crimp Terminals](#)