

**PLEASE CHECK WWW.MOLEX.COM FOR LATEST PART INFORMATION**

**Part Number:** [19419-0015](#)  
**Status:** **Active**  
**Overview:** [MX150L™ Sealed Connector System](#)  
**Description:** [MX150L™ 10 Circuit Plug for 18-22 AWG Wire](#)

**Documents:**

<a href="#">3D Model</a>	<a href="#">Application Specification AS-19417-001 (PDF)</a>
<a href="#">Drawing (PDF)</a>	<a href="#">RoHS Certificate of Compliance (PDF)</a>
<a href="#">Product Specification PS-19417-001 (PDF)</a>	<a href="#">Product Literature (PDF)</a>

**Agency Certification**

CSA	LR18689
UL	E152602

**General**

Product Family	Crimp Housings
Series	<a href="#">19419</a>
Application	Power, Wire-to-Wire
Comments	IP67 rated; conforms to UL 1977. NOT suitable for automotive applications with requirements such as USCAR-2, USCAR-25, GMW3191, AK Testing, J2030, Volvo Technology Requirements, and Toyota Connector Spec (TCS)
Overview	<a href="#">MX150L™ Sealed Connector System</a>
Product Literature Order No	987650-2181
Product Name	MX150L™
UPC	822348020010

**Physical**

Circuits (maximum)	10
Flammability	94V-0
Gender	Male
Glow-Wire Compliant	No
Lock to Mating Part	Yes
Net Weight	21.958/g
Number of Rows	2
Packaging Type	Bag
Panel Mount	No
Pitch - Mating Interface	5.84mm
Polarized to Mating Part	Yes
Stackable	No
Temperature Range - Operating	-40°C to +125°C

**Electrical**

Current - Maximum per Contact	18A
-------------------------------	-----

**Material Info**

**Reference - Drawing Numbers**

Application Specification	AS-19417-001
Product Specification	PS-19417-001
Sales Drawing	SD-19419-005

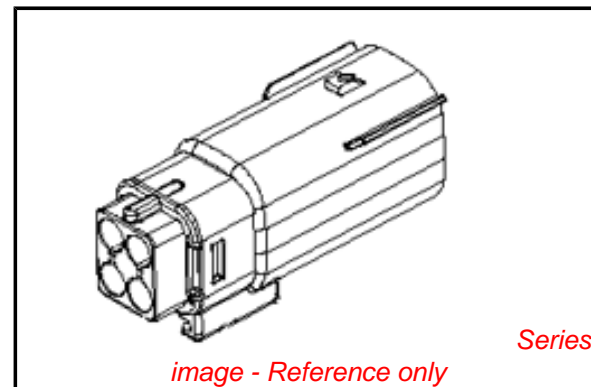

**EU RoHS**

**ELV and RoHS Compliant**  
**REACH SVHC**  
 Not Reviewed  
**Low-Halogen Status**  
 Not Reviewed

**China RoHS**



**Need more information on product environmental compliance?**

Email [productcompliance@molex.com](mailto:productcompliance@molex.com)  
 For a multiple part number RoHS Certificate of Compliance, [click here](#)

Please visit the [Contact Us](#) section for any non-product compliance questions.

**Search Parts in this Series**

[19419Series](#)

**Mates With**

[19418 Receptacle Assemblies](#)

**Use With**

[19417 Male Crimp Terminals](#)