

PST 1,3/17-5,0 - Pin strip



1935556

<https://www.phoenixcontact.com/de/produkte/1935556>

Please be informed that the data shown in this PDF document is generated from our Online Catalog. Please find the complete data in the user documentation. Our General Terms of Use for Downloads are valid.



Pin strip, nominal cross section: 1.5 mm², color: black, nominal current: 12 A (depends on the plug used), rated voltage (III/2): 320 V, contact surface: Tin, type of contact: Male connector, number of potentials: 17, number of rows: 1, number of positions: 17, number of connections: 17, product range: PST 1,3/..-V, pitch: 5 mm, mounting: THR soldering, pin layout: Linear pinning, solder pin [P]: 3.5 mm, plug-in system: COMBICON PST 1,3, locking: without, mounting: without, type of packaging: packed in cardboard, The maximum current depends on the plug used. The lower of the two current values apply for plug and pin strip. The pin strip is made of highly temperature resistant plastic and is thus suitable for the reflow process.

Your advantages

- Suitable for wave and reflow soldering processes
- Optimum pin geometry for all COMBICON pin strip connectors

Commercial Data

Item number	1935556
Packing unit	50 pc
Minimum order quantity	1 pc
Note	Made to Order (non-returnable)
Sales Key	E1 - Leiterplattenanschl.
Product Key	AACTFA
GTIN	4017918920487
Weight per Piece (including packing)	2,75 g
Weight per Piece (excluding packing)	2,693 g
Customs tariff number	85366930
Country of origin	DE

PST 1,3/17-5,0 - Pin strip

1935556

<https://www.phoenixcontact.com/de/produkte/1935556>

Technical Data

Product properties

Type	Pin strip
Product line	COMBICON Connectors M
Product type	Pin strip
Product family	PST 1,3/..-V
Number of positions	17
Pitch	5 mm
Number of connections	17
Number of rows	1
Mounting flange	without
Number of potentials	17
Pin layout	Linear pinning

Electrical properties

Nominal current I_N	12 A (depends on the plug used)
Nominal voltage U_N	320 V
Degree of pollution	3
Contact resistance	1.6 m Ω
Rated voltage (III/3)	250 V
Rated surge voltage (III/3)	4 kV
Rated voltage (III/2)	320 V
Rated surge voltage (III/2)	4 kV
	400 V
Rated surge voltage (II/2)	4 kV

Mounting

Mounting type	THR soldering
Pin layout	Linear pinning

Processing notes

Moisture Sensitive Level	MSL 1
Classification temperature T_c	260 °C
Solder cycles in the reflow	3

Material specifications

Material data - contact

Note	WEEE/RoHS-compliant, free of whiskers according to IEC 60068-2-82/JEDEC JESD 201
Contact material	Cu alloy
Surface characteristics	Tin-plated
Metal surface contact area (top layer)	Tin (3 - 5 μm Sn)
Metal surface contact area (middle layer)	Nickel (1 - 3 μm Ni)

PST 1,3/17-5,0 - Pin strip

1935556

<https://www.phoenixcontact.com/de/produkte/1935556>

Metal surface soldering area (top layer)	Tin (3 - 5 μm Sn)
Metal surface soldering area (middle layer)	Nickel (1 - 3 μm Ni)

Material data - housing

Color (Housing)	black (9005)
Insulating material	PA
Insulating material group	IIIa
CTI according to IEC 60112	250
Flammability rating according to UL 94	V0
Glow wire flammability index GWFI according to EN 60695-2-12	850
Glow wire ignition temperature GWIT according to EN 60695-2-13	775
Temperature for the ball pressure test according to EN 60695-10-2	125 °C

Material data – actuating element

Color ()	()
-----------	-----

Dimensions

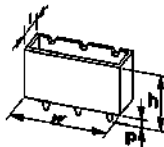
Dimensional drawing	
Pitch	5 mm
Width [w]	85 mm
Height [h]	13 mm
Length [l]	2.8 mm
Installed height	9.5 mm
Solder pin length [P]	3.5 mm

Mechanical tests

Test for conductor damage and slackening

Specification	IEC 60999-1:1999-11
Result	Test passed

Repeated connection and disconnection

Specification	IEC 60999-1:1999-11
Result	Test passed

Pull-out test

Specification	IEC 60999-1:1999-11
Conductor cross section/conductor type/tractive force setpoint/actual value	0.2 mm ² / solid / > 10 N
	0.2 mm ² / flexible / > 10 N
	2.5 mm ² / solid / > 50 N

PST 1,3/17-5,0 - Pin strip



1935556

<https://www.phoenixcontact.com/de/produkte/1935556>

	2.5 mm ² / flexible / > 50 N
--	---

Insertion and withdrawal forces

Result	Test passed
No. of cycles	25
Insertion strength per pos. approx.	5 N
Withdraw strength per pos. approx.	5 N

Contact holder in insert

Specification	IEC 60512-15-1:2008-05
Contact holder in insert Requirements >20 N	Test passed

Resistance of inscriptions

Specification	IEC 60068-2-70:1995-12
Result	Test passed

Visual inspection

Specification	IEC 60512-1-1:2002-02
Result	Test passed

Dimension check

Specification	IEC 60512-1-2:2002-02
Result	Test passed

Electrical tests

Thermal test | Test group C

Specification	IEC 60512-5-1:2002-02
Tested number of positions	12

Insulation resistance

Specification	IEC 60512-3-1:2002-02
Insulation resistance, neighboring positions	> 5 MΩ

Temperature cycles

Specification	IEC 60999-1:1999-11
Result	Test passed

Air clearances and creepage distances |

Specification	IEC 60664-1:2007-04
Insulating material group	IIIa
Comparative tracking index (IEC 60112)	CTI 250
Rated insulation voltage (III/3)	250 V
Rated surge voltage (III/3)	4 kV
minimum clearance value - non-homogenous field (III/3)	3 mm
minimum creepage distance (III/3)	4 mm
Rated insulation voltage (III/2)	320 V

PST 1,3/17-5,0 - Pin strip



1935556

<https://www.phoenixcontact.com/de/produkte/1935556>

Rated surge voltage (III/2)	4 kV
minimum clearance value - non-homogenous field (III/2)	3 mm
minimum creepage distance (III/2)	3.2 mm
Rated insulation voltage (II/2)	400 V
Rated surge voltage (II/2)	4 kV
minimum clearance value - non-homogenous field (II/2)	3 mm
minimum creepage distance (II/2)	4 mm

Environmental and real-life conditions

Vibration test

Specification	IEC 60068-2-6:2007-12
Frequency	10 - 150 - 10 Hz
Sweep speed	1 octave/min
Amplitude	0.35 mm (10 Hz ... 60.1 Hz)
Sweep speed	5g (60.1 Hz ... 150 Hz)
Test duration per axis	2.5 h

Durability test

Specification	IEC 60512-9-1:2010-03
Impulse withstand voltage at sea level	4.8 kV
Contact resistance R_1	1.6 m Ω
Contact resistance R_2	1.7 m Ω
Insertion/withdrawal cycles	25
Insulation resistance, neighboring positions	> 5 M Ω

Climatic test

Specification	ISO 6988:1985-02
Corrosive stress	0.2 dm ³ SO ₂ on 300 dm ³ /40 °C/1 cycle
Thermal stress	100 °C/168 h
Power-frequency withstand voltage	2.21 kV

Ambient conditions

Ambient temperature (operation)	-40 °C ... 100 °C (dependent on the derating curve)
Ambient temperature (storage/transport)	-40 °C ... 70 °C
Relative humidity (storage/transport)	30 % ... 70 %
Ambient temperature (assembly)	-5 °C ... 100 °C

Packaging specifications

Type of packaging	packed in cardboard
-------------------	---------------------

Drawings

Dimensional drawing

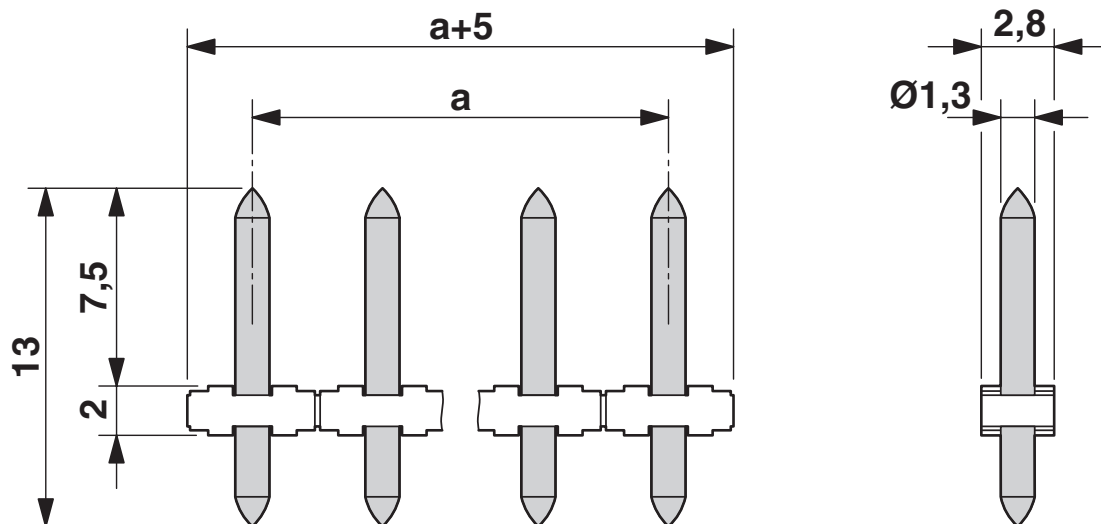

Diagram

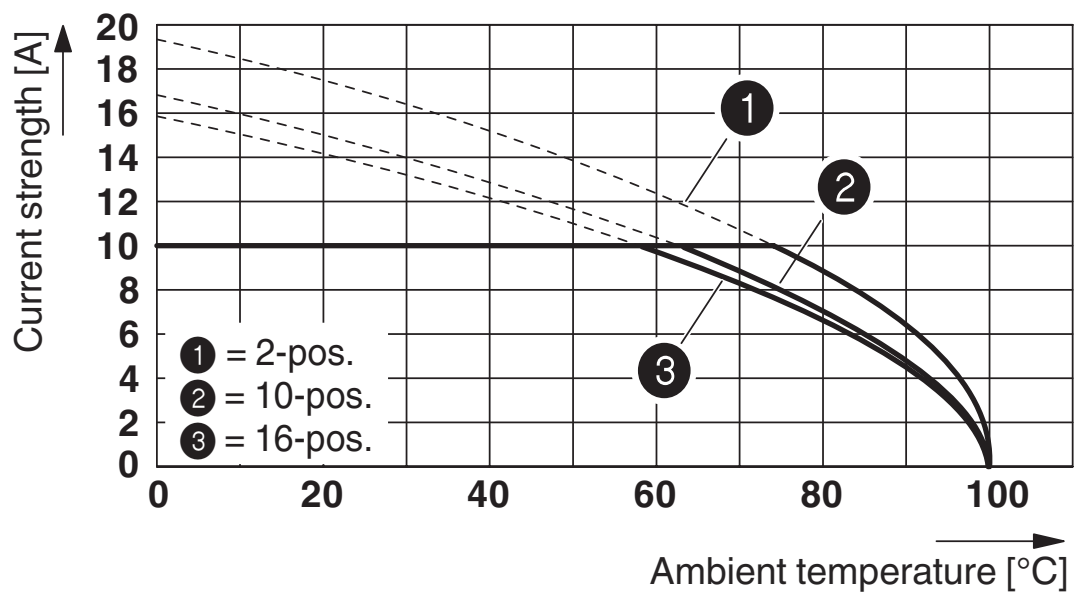

Derating curve for: PT 1,5/...-PH-5,0 with PST 1,3/...5,0

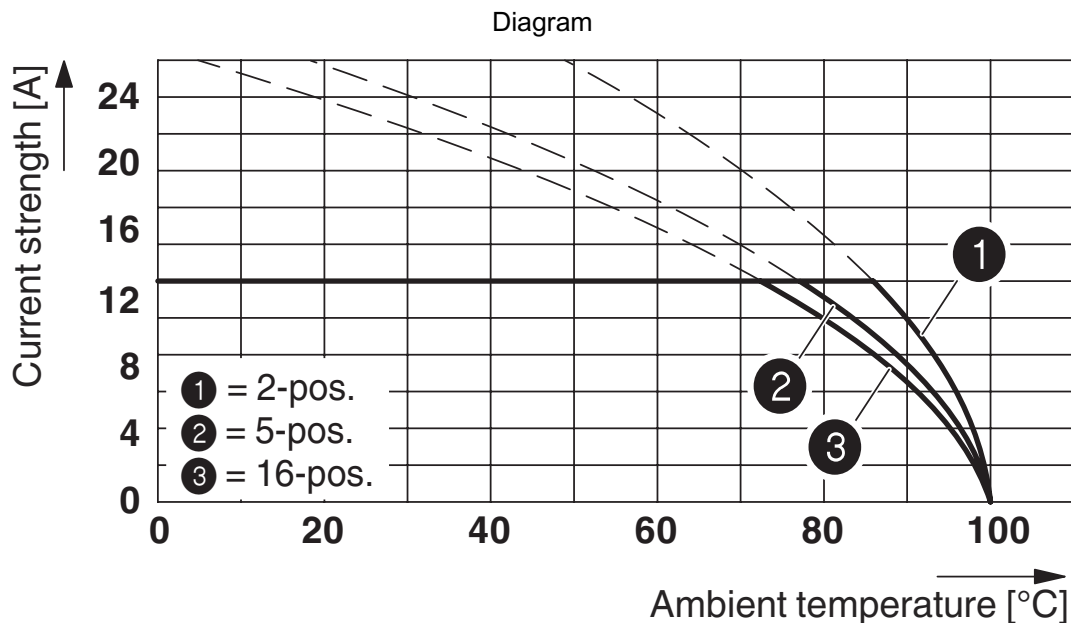

Type: PT 1,5/...-PVH-5,0 with PST 1,3/...-5,0

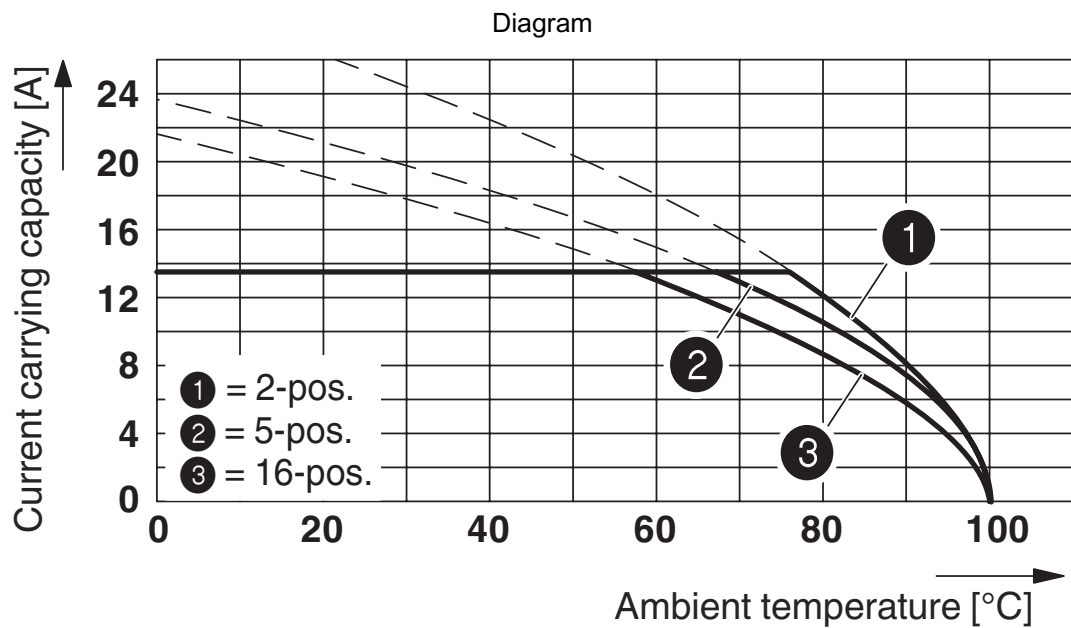

Type: PTDA 2,5/...-PH-5,0 with PST 1,3/...-5,0

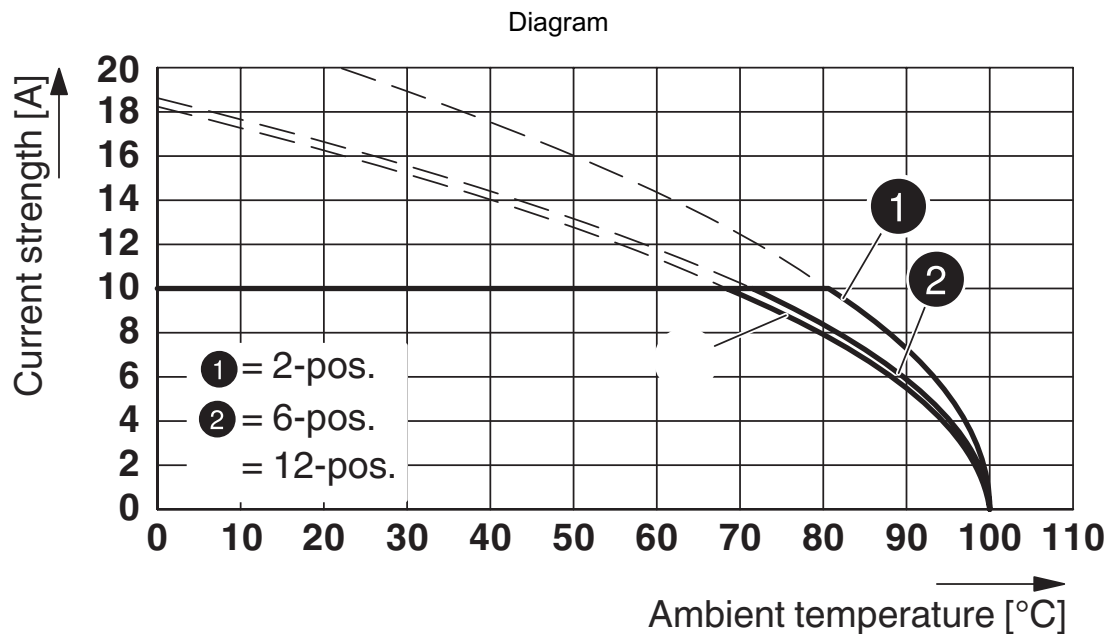

Type: PTS 1,5/...-PH-5,0 CLIP with PST 1,3/...-5,0

Drilling plan/solder pad geometry

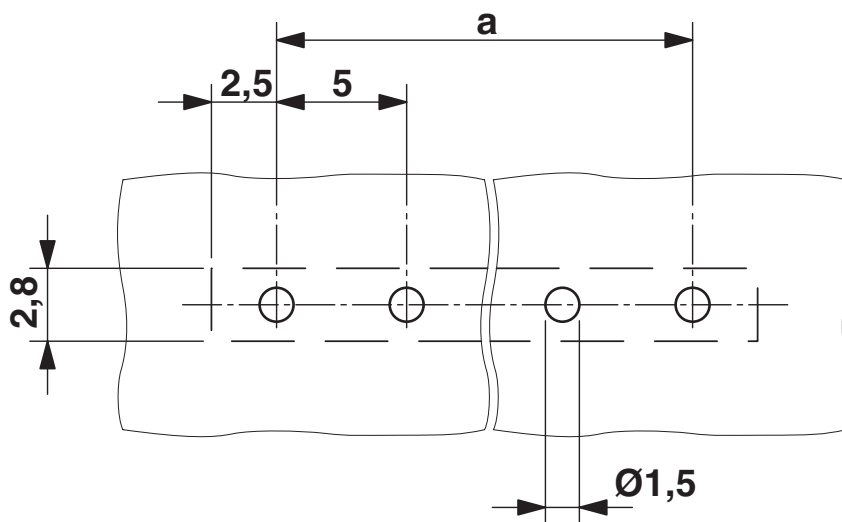

PST 1,3/17-5,0 - Pin strip

1935556

<https://www.phoenixcontact.com/de/produkte/1935556>



Diagram

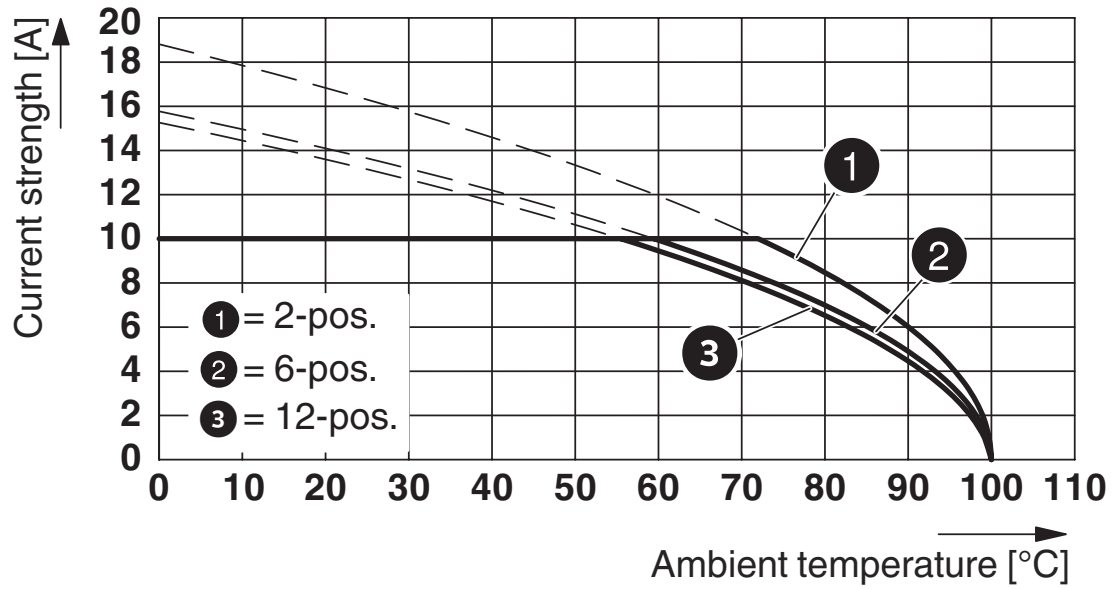

Type: PTS 1,5/...-PH-5,0 with PST 1,3/...-5,0

PST 1,3/17-5,0 - Pin strip





1935556

<https://www.phoenixcontact.com/de/produkte/1935556>

Approvals

 IECEE CB Scheme Approval ID: DE1-60320				
	Nominal Voltage U_N	Nominal Current I_N	Cross Section AWG	Cross Section mm^2
	320 V	10 A	-	-

 EAC Approval ID: B.01687				
--	--	--	--	--

 cULus Recognized Approval ID: E60425-20030211				
	Nominal Voltage U_N	Nominal Current I_N	Cross Section AWG	Cross Section mm^2
Use group B				
	300 V	16 A	-	-
Use group D				
	300 V	10 A	-	-

 VDE Gutachten mit Fertigungsüberwachung Approval ID: 40040542				
	Nominal Voltage U_N	Nominal Current I_N	Cross Section AWG	Cross Section mm^2
	320 V	10 A	-	-

PST 1,3/17-5,0 - Pin strip

1935556

<https://www.phoenixcontact.com/de/produkte/1935556>



Classifications

ECLASS

ECLASS-9.0	27440402
ECLASS-10.0.1	27440402
ECLASS-11.0	27460201

ETIM

ETIM 8.0	EC002637
----------	----------

UNSPSC

UNSPSC 21.0	39121400
-------------	----------

PST 1,3/17-5,0 - Pin strip

1935556

<https://www.phoenixcontact.com/de/produkte/1935556>



Environmental Product Compliance

China RoHS	Environmentally friendly use period: unlimited = EFUP-e
	No hazardous substances above threshold values

PST 1,3/17-5,0 - Pin strip

1935556

<https://www.phoenixcontact.com/de/produkte/1935556>



Accessories

PTDA 2,5/ 2-PH-5,0 - PCB connector

1725497

<https://www.phoenixcontact.com/de/produkte/1725497>



PCB connector, nominal cross section: 2.5 mm², color: green, nominal current: 14 A, rated voltage (III/2): 400 V, contact surface: Tin, type of contact: Female connector, number of potentials: 2, number of rows: 1, number of positions: 2, number of connections: 4, product range: PTDA 2,5/..-PH, pitch: 5 mm, connection method: Push-in spring connection, conductor/PCB connection direction: 45 °, plug-in system: COMBICON PST 1,3, locking: without, mounting: without, type of packaging: packed in cardboard

PT 1,5/ 2-PH-5,0 - PCB connector

1755583

<https://www.phoenixcontact.com/de/produkte/1755583>



PCB connector, nominal cross section: 1.5 mm², color: green, nominal current: 10 A, rated voltage (III/2): 400 V, contact surface: Tin, type of contact: Female connector, number of potentials: 2, number of rows: 1, number of positions: 2, number of connections: 2, product range: PT 1,5/..-PH, pitch: 5 mm, connection method: Screw connection with tension sleeve, screw head form: H1L Philipps recess with slotted Torx, conductor/PCB connection direction: 0 °, plug-in system: COMBICON PST 1,3, locking: without, mounting: without, type of packaging: packed in cardboard

PST 1,3/17-5,0 - Pin strip

1935556

<https://www.phoenixcontact.com/de/produkte/1935556>



PT 1,5/ 2-PH-5,0 CLIP - PCB connector

1755732

<https://www.phoenixcontact.com/de/produkte/1755732>



PCB connector, nominal cross section: 1.5 mm², color: green, nominal current: 10 A, rated voltage (III/2): 400 V, contact surface: Tin, type of contact: Female connector, number of potentials: 2, number of rows: 2, number of positions: 2, number of connections: 2, product range: PT 1,5/...-PH CLIP, pitch: 5 mm, connection method: Screw connection with tension sleeve, screw head form: H1L Philipps recess with slotted Torx, conductor/PCB connection direction: 0 °, plug-in system: COMBICON PST 1,3, locking: without, mounting: without, type of packaging: packed in cardboard

PT 1,5/ 2-PVH-5,0 - PCB connector

1934861

<https://www.phoenixcontact.com/de/produkte/1934861>

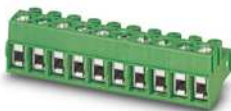

PCB connector, nominal cross section: 1.5 mm², color: green, nominal current: 12 A, rated voltage (III/2): 400 V, contact surface: Tin, type of contact: Female connector, number of potentials: 2, number of rows: 1, number of positions: 2, number of connections: 2, product range: PT 1,5/...-PVH, pitch: 5 mm, connection method: Screw connection with wire protector, screw head form: H1L Philipps recess with slotted Torx, conductor/PCB connection direction: 0 °, plug-in system: COMBICON PST 1,3, locking: without, mounting: without, type of packaging: packed in cardboard

PST 1,3/17-5,0 - Pin strip

1935556

<https://www.phoenixcontact.com/de/produkte/1935556>



PT 2,5/ 2-PVH-5,0 - Printed-circuit board connector

1704165

<https://www.phoenixcontact.com/de/produkte/1704165>

PCB connector, color: green, contact surface: Tin, number of positions: 2, product range: PT 2,5/...-PVH, pitch: 5 mm, type of packaging: packed in cardboard



PTS 1,5/ 2-PH-5,0 - Printed-circuit board connector

1805517

<https://www.phoenixcontact.com/de/produkte/1805517>

PCB connector, nominal cross section: 1.5 mm², color: green, nominal current: 10 A, rated voltage (III/2): 400 V, contact surface: Tin, type of contact: Female connector, number of potentials: 2, number of rows: 1, number of positions: 2, number of connections: 2, product range: PTS 1,5/...-PH, pitch: 5 mm, connection method: Push-in spring connection, conductor/PCB connection direction: 0 °, plug-in system: COMBICON PST 1,3, locking: without, mounting: without, type of packaging: packed in cardboard



PST 1,3/17-5,0 - Pin strip

1935556

<https://www.phoenixcontact.com/de/produkte/1935556>



PTS 1,5/ 2-PH-5,0 CLIP - Printed-circuit board connector

1848532

<https://www.phoenixcontact.com/de/produkte/1848532>



PCB connector, nominal cross section: 1.5 mm², color: green, nominal current: 10 A, rated voltage (III/2): 400 V, contact surface: Tin, type of contact: Female connector, number of potentials: 2, number of rows: 1, number of positions: 2, number of connections: 2, product range: PTS 1,5/..-PH CLIP, pitch: 5 mm, connection method: Push-in spring connection, conductor/PCB connection direction: 0 °, plug-in system: COMBICON PST 1,3, locking: without, type of packaging: packed in cardboard

Phoenix Contact 2023 © - all rights reserved

<https://www.phoenixcontact.com>

PHOENIX CONTACT Deutschland GmbH

Flachsmarktstraße 8

D-32825 Blomberg

+49 52 35/3-1 20 00

info@phoenixcontact.de