



Get .64 Connector System

TE Internal #: 1924941-1

TE Internal Description: PLUG ASSY, 96P GPEC II KEY C RIGHT EXIT

[View on TE.com >](#)



Product Compliance

[For compliance documentation, visit the product page on TE.com>](#)

EU RoHS Directive 2011/65/EU	Compliant
EU ELV Directive 2000/53/EC	Compliant
China RoHS 2 Directive MIIT Order No 32, 2016	No Restricted Materials Above Threshold
EU REACH Regulation (EC) No. 1907/2006	<p>Current ECHA Candidate List: JUNE 2024 (241) Candidate List Declared Against: JAN 2024 (240) SVHC > Threshold: Octamethylcyclotetrasiloxane (D4) (.5% in Component Part) Dodecamethylcyclohexasiloxane (D6) (.5% in Component Part) Decamethylcyclopentasiloxane (D5) (.5% in Component Part)</p> <p>Article Safe Usage Statements: Wash thoroughly after handling. Recycle if possible and dispose of the article by following all applicable governmental regulations relevant to your geographic location.</p>
Halogen Content	BFR/CFR/PVC Free, but Br/Cl >900 ppm in other sources.
Solder Process Capability	Not applicable for solder process capability

Product Compliance Disclaimer

This information is provided based on reasonable inquiry of our suppliers and represents our current actual knowledge based on the information they provided. This information is subject to change. The part numbers that TE has identified as EU RoHS compliant have a maximum concentration of 0.1% by weight in homogenous materials for lead, hexavalent chromium, mercury, PBB, PBDE, DBP, BBP, DEHP, DIBP, and 0.01% for cadmium, or qualify for an exemption to these limits as defined in the Annexes of Directive 2011/65/EU (RoHS2). Finished electrical and electronic equipment products will be CE marked as required by Directive 2011/65/EU. Components may not be CE marked. Additionally, the part numbers that TE has identified as EU ELV compliant have a maximum concentration of 0.1% by weight in homogenous materials for lead, hexavalent chromium, and mercury, and 0.01% for cadmium, or qualify for an exemption to these limits as defined in the Annexes of Directive 2000/53/EC (ELV). Regarding the REACH Regulation, the information TE provides

on SVHC in articles for this part number is based on the latest European Chemicals Agency (ECHA) 'Guidance on requirements for substances in articles' posted at this URL: <https://echa.europa.eu/guidance-documents/guidance-on-reach>

Compatible Parts



TE Part # CAT-G3353-T273
GET .64 CONNECTOR SYSTEM, RECEPT AND TAB



TE Part # 1924779-1
WIRE DRESS ASSY, 96P GPEC II



TE Part # 1924880-1
GET, FEMALE TERMINAL, AGSN, 16



TE Part # 1924879-1
GET, FEMALE TERMINAL, AGSN, TH

TE Part # 1924774-1
SEAL COVER, 96P GPEC II

TE Part # 1924775-1
MATTE WIRE SEAL, 96P GPEC II

TE Part # 1924776-1
PERIPHERAL SEAL, 96P GPEC II

TE Part # 1924777-1
ALPHA SLIDE, 96P GPEC II

TE Part # 1924778-1
BETA SLIDE, 96P GPEC II

TE Part # 1924772-1
PLUG HOUSING, 96P GPEC II

TE Part # 1924773-3
TPA, 96P GPEC II KEY C

Also in the Series | Get .64 Connector System



Automotive Connector Caps & Covers (5)



Automotive Housings(109)



Automotive Terminals(28)



Insertion & Extraction Tools(1)

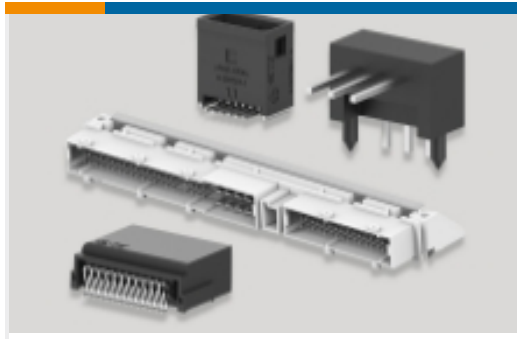

PCB Headers & Receptacles(3)

Customers Also Bought



TE Part #2138314-1
36P SEALED HYBRID (32X 1.2, 4X

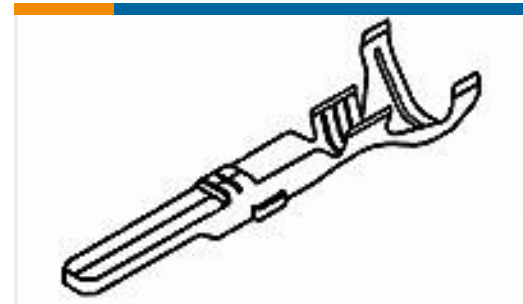

TE Part #881590-1
ECONOSEAL TAB .070



TE Part #184340-1
PLUG ASSY,2X2,CPA,W/O SLOT,CKT4
BLKD



TE Part #1924779-1
WIRE DRESS ASSY, 96P GPEC II



TE Part #184311-1
ASSY, PLUG HSG 3 POS, KEY A



TE Part #638517-5
PLUG ASSY, 10PSON SEALED KEY A



TE Part #184116-1
2 POS. PLUG ASSY, KEY H 1/2



TE Part #1924943-1
PLUG ASSY, 96P GPEC II KEY E RIGHT
EXIT

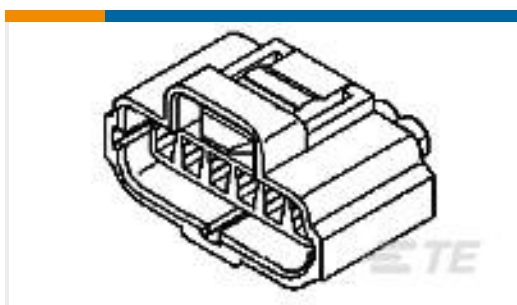

TE Part #184124-1
6 POS./6 CIRC. PLUG ASSY,KEY B



TE Part #1924939-1
PLUG ASSY, 96P GPEC II KEY A RIGHT
EXIT

Documents

Product Drawings

[PLUG ASSY, 96P GPEC II KEY C RIGHT EXIT](#)

English

CAD Files

[Customer View Model](#)

[ENG_CVM_CVM_1924941-1_C1.3d_igs.zip](#)

English

[3D PDF](#)



3D

Customer View Model

[ENG_CVM_CVM_1924941-1_C1.3d_stp.zip](#)

English

Customer View Model

[ENG_CVM_CVM_1924941-1_C1.2d_dxf.zip](#)

English

By downloading the CAD file I accept and agree to the [Terms and Conditions](#) of use.

Instruction Sheets

[Instruction Sheet \(U.S.\)](#)

English

[Instruction Sheet \(U.S.\)](#)

English