

Base strip - PC 6-16/ 4-G-10,16 - 1913662

Please be informed that the data shown in this PDF Document is generated from our Online Catalog. Please find the complete data in the user's documentation. Our General Terms of Use for Downloads are valid (<http://phoenixcontact.com/download>)



Header, Nominal current: 41 A, Rated voltage (III/2): 1000 V, Number of positions: 4, Pitch: 10.16 mm, Color: green, Contact surface: Silver, Mounting: Wave soldering, The nominal current of 76 A applies in connection with connectors from the PC 16 family. 41 A are reached in connection with PC 6 connectors (50 A in accordance with UL).

The illustration shows an 8-position version

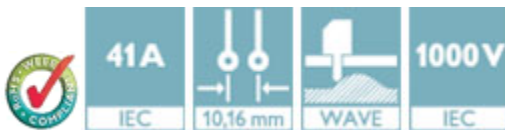

Key Commercial Data

Packing unit	1 pc
Minimum order quantity	50 pc
GTIN	 4 017918 179144
Weight per Piece (excluding packing)	16.2 g
Custom tariff number	85366990
Country of origin	Poland

Technical data

Dimensions

Length	32 mm
Pitch	10.16 mm
Dimension a	30.48 mm
Constructional height	14 mm
Height	13.7 mm
Length of the solder pin	5 mm

General

Range of articles	PC 6-16/..-G
Rated surge voltage (III/3)	6 kV

Base strip - PC 6-16/ 4-G-10,16 - 1913662

Technical data

General

Rated surge voltage (III/2)	8 kV
Rated surge voltage (II/2)	8 kV
Rated voltage (III/2)	1000 V
Rated voltage (II/2)	1000 V
Connection in acc. with standard	EN-VDE
Nominal current I _N	41 A
Color	green
Number of positions	4

Standards and Regulations

Connection in acc. with standard	EN-VDE
	CUL

Classifications

eCl@ss

eCl@ss 4.0	272607xx
eCl@ss 4.1	27260701
eCl@ss 5.0	27260701
eCl@ss 5.1	27260701
eCl@ss 6.0	27260704
eCl@ss 7.0	27440402
eCl@ss 8.0	27440402
eCl@ss 9.0	27440402

ETIM

ETIM 3.0	EC001121
ETIM 4.0	EC002637
ETIM 5.0	EC002637

UNSPSC

UNSPSC 6.01	30211810
UNSPSC 7.0901	39121409
UNSPSC 11	39121409
UNSPSC 12.01	39121409
UNSPSC 13.2	39121409

Base strip - PC 6-16/ 4-G-10,16 - 1913662

Approvals

Approvals

Approvals

UL Recognized / SEV / cUL Recognized / EAC / IECCE CB Scheme / EAC / cULus Recognized

Ex Approvals

Approvals submitted

Approval details

UL Recognized 			
	B	C	D
Nominal current IN	66 A	66 A	5 A
Nominal voltage UN	300 V	300 V	600 V

SEV	
Nominal current IN	76 A
Nominal voltage UN	1000 V

cUL Recognized 			
	B	C	D
Nominal current IN	66 A	66 A	5 A
Nominal voltage UN	300 V	300 V	600 V

EAC

Base strip - PC 6-16/ 4-G-10,16 - 1913662

Approvals

IECEE CB Scheme 	
Nominal current I _N	76 A
Nominal voltage U _N	1000 V

EAC

cULus Recognized 

Drawings

Base strip - PC 6-16/ 4-G-10,16 - 1913662

Drilling diagram

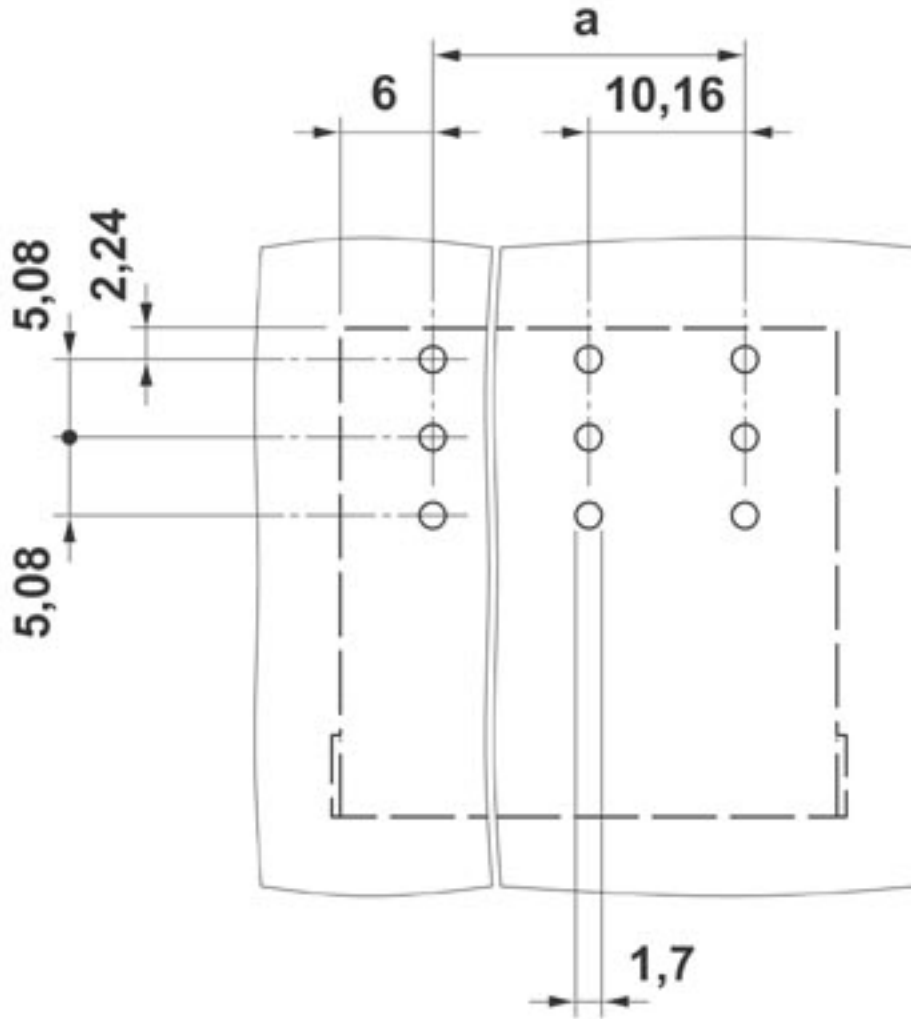

Base strip - PC 6-16/ 4-G-10,16 - 1913662

Dimensional drawing

