

LSF-SMT 3.50/08/180 1.5SN BK RL

Weidmüller Interface GmbH & Co. KG

Klingenbergstraße 26

D-32758 Detmold

Germany

www.weidmueller.com

Product image

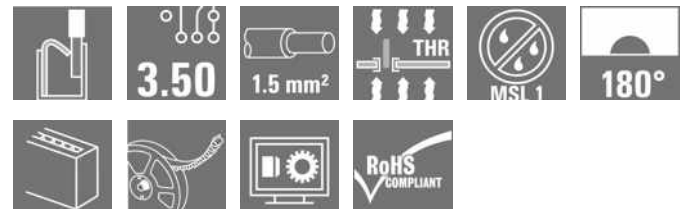

Similar to illustration

PCB terminal for fully automatic assembly in reflow soldering (SMT), with PUSH IN conductor connection system. Conductor inserted and slider operated in same direction (TOP). Packed in box or as tape on reel. Pin lengths optimised at 1.5 mm or 3.5 mm.

General ordering data

Version	Printed circuit board terminals, 3.50 mm, Number of poles: 8, 180°, Solder pin length (l): 1.5 mm, black, PUSH IN with actuator, Clamping range, max.: 1.5 mm ² , Tape
Order No.	1874350000
Type	LSF-SMT 3.50/08/180 1.5SN BK RL
GTIN (EAN)	4032248459025
Qty.	175 pc(s).
Product data	IEC: 320 V / 17.5 A / 0.2 - 1.5 mm ² UL: 300 V / 12 A / AWG 28 - AWG 14
Packaging	Tape

Creation date February 2, 2023 11:42:13 AM CET

LSF-SMT 3.50/08/180 1.5SN BK RL

Weidmüller Interface GmbH & Co. KG

Klingenbergstraße 26

D-32758 Detmold

Germany

www.weidmueller.com

Technical data

Dimensions and weights

Depth	7.8 mm	Depth (inches)	0.307 inch
Height	15.5 mm	Height (inches)	0.61 inch
Height of lowest version	14 mm	Width	28.7 mm
Width (inches)	1.13 inch	Net weight	6.263 g

Temperatures

Operating temperature, min.	-50 °C	Operating temperature, max.	120 °C
Continuous operating temp., max.	120 °C		

System parameters

Product family	OMNIMATE Signal - series LSF	Wire connection method	PUSH IN with actuator
Mounting onto the PCB	THT/THR solder connection	Conductor outlet direction	180°
Pitch in mm (P)	3.5 mm	Pitch in inches (P)	0.138 inch
Number of poles	8	Pin series quantity	1
Fitted by customer	No	Number of rows	1
Solder pin length (l)	1.5 mm	Solder pin length tolerance	+0.1 / -0.3
Solder pin dimensions	0.35 x 0.8 mm	Solder pin dimensions = d tolerance	0 / -0.1 mm
Solder eyelet hole diameter (D)	1.1 mm	Solder eyelet hole diameter tolerance (D)	+0,1 mm
Number of solder pins per pole	2	Stripping length	8 mm
L1 in mm	24.5 mm	L1 in inches	0.965 inch
Touch-safe protection acc. to DIN VDE 0470	IP 20	Touch-safe protection acc. to DIN VDE 57 106	Safe from finger touch
Protection degree	IP20	Volume resistance	1.60 mΩ

Material data

Insulating material	LCP GF	Colour	black
Colour chart (similar)	RAL 9011	Insulating material group	Illa
Comparative Tracking Index (CTI)	≥ 175	Moisture Level (MSL)	1
UL 94 flammability rating	V-0	Contact material	Copper alloy
Layer structure of solder connection	4...6 µm Sn matt	Storage temperature, min.	-40 °C
Storage temperature, max.	70 °C	Operating temperature, min.	-50 °C
Operating temperature, max.	120 °C	Temperature range, installation, min.	-30 °C
Temperature range, installation, max.	120 °C		

Conductors suitable for connection

Clamping range, min.	0.13 mm ²
Clamping range, max.	1.5 mm ²
Wire connection cross section AWG, min.	AWG 28
Wire connection cross section AWG, max.	AWG 14
Solid, min. H05(07) V-U	0.2 mm ²
Solid, max. H05(07) V-U	1.5 mm ²
Flexible, min. H05(07) V-K	0.2 mm ²
Flexible, max. H05(07) V-K	1.5 mm ²
w. plastic collar ferrule, DIN 46228 pt 4, min.	0.25 mm ²
w. plastic collar ferrule, DIN 46228 pt 4, max.	0.75 mm ²

Creation date February 2, 2023 11:42:13 AM CET

Catalogue status 24.01.2023 / We reserve the right to make technical changes.

LSF-SMT 3.50/08/180 1.5SN BK RL

Weidmüller Interface GmbH & Co. KG
 Klingenbergstraße 26
 D-32758 Detmold
 Germany

www.weidmueller.com

Technical data

w. wire end ferrule, DIN 46228 pt 1, min. 0.25 mm²

w. wire end ferrule, DIN 46228 pt 1, max. 1.5 mm²

Clampable conductor	Cross-section for conductor connection	Type	fine-wired
		nominal	0.25 mm ²
wire end ferrule	wire end ferrule	Stripping length	nominal 10 mm
		Recommended wire-end ferrule	H0.25/12 HBL
Cross-section for conductor connection	Cross-section for conductor connection	Type	fine-wired
		nominal	0.34 mm ²
wire end ferrule	wire end ferrule	Stripping length	nominal 10 mm
		Recommended wire-end ferrule	H0.34/12 TK
Cross-section for conductor connection	Cross-section for conductor connection	Type	fine-wired
		nominal	0.5 mm ²
wire end ferrule	wire end ferrule	Stripping length	nominal 10 mm
		Recommended wire-end ferrule	H0.5/14 OR
Cross-section for conductor connection	Cross-section for conductor connection	Type	fine-wired
		nominal	0.75 mm ²
wire end ferrule	wire end ferrule	Stripping length	nominal 10 mm
		Recommended wire-end ferrule	H0.75/14T HBL

Reference text Length of ferrules is to be chosen depending on the product and the rated voltage., The outside diameter of the plastic collar should not be larger than the pitch (P)

Rated data acc. to IEC

tested acc. to standard	IEC 60664-1, IEC 61984	Rated current, min. number of poles (Tu=20°C)	17.5 A
Rated current, max. number of poles (Tu=20°C)	16 A	Rated current, min. number of poles (Tu=40°C)	17.5 A
Rated current, max. number of poles (Tu=40°C)	14 A	Rated voltage for surge voltage class / pollution degree II/2	320 V
Rated voltage for surge voltage class / pollution degree III/2	160 V	Rated voltage for surge voltage class / pollution degree III/3	160 V
Rated impulse voltage for surge voltage class/ pollution degree II/2	2.5 kV	Rated impulse voltage for surge voltage class/ pollution degree III/2	2.5 kV
Rated impulse voltage for surge voltage class/ contamination degree III/3	2.5 kV	Short-time withstand current resistance	3 x 1s with 80 A

Rated data acc. to CSA

Institute (CSA)		Certificate No. (CSA)	200039-1664286
Rated voltage (Use group B / CSA)	300 V	Rated voltage (Use group D / CSA)	300 V
Rated current (Use group B / CSA)	10 A	Rated current (Use group D / CSA)	10 A
Wire cross-section, AWG, min.	AWG 28	Wire cross-section, AWG, max.	AWG 14
Reference to approval values	Specifications are maximum values, details - see approval certificate.		

LSF-SMT 3.50/08/180 1.5SN BK RL

Weidmüller Interface GmbH & Co. KG
 Klingenbergstraße 26
 D-32758 Detmold
 Germany

www.weidmueller.com

Technical data

Rated data acc. to UL 1059

Institute (cURus)



Certificate No. (cURus)

E60693

Rated voltage (Use group B / UL 1059)	300 V
Rated current (Use group B / UL 1059)	12 A
Wire cross-section, AWG, min.	AWG 28
Reference to approval values	Specifications are maximum values, details - see approval certificate.

Rated voltage (Use group D / UL 1059)	300 V
Rated current (Use group D / UL 1059)	10 A
Wire cross-section, AWG, max.	AWG 14

Packing

Packaging	Tape
VPE width	332 mm
Tape depth (T2)	20 mm
Tape pocket depth (K0)	19.5 mm
Tape pocket width (B0)	29 mm
Tape hole separation (E)	1.75 mm
Tape reel diameter \varnothing (A)	330 mm
Width Pick & Place Pad (W_{PPP})	7.5 mm
Diameter of the withdrawal surface ($\varnothing D_{max}$)	9 mm

VPE length	332 mm
VPE height	53 mm
Tape width (W)	44 mm
Tape pocket height (A0)	8.05 mm
Tape pocket separation (P1)	20 mm
Tape pocket separation (F)	20.2 mm
Surface resistance	$R_s = 10^9 - 10^{12} \Omega$
Length Pick & Place Pad (L_{PPP})	8.5 mm

Type tests

Test: Durability of markings	Test	mark of origin, type identification, pitch, durability
	Evaluation	available
	Test	approval marking UL
	Evaluation	on packaging label

LSF-SMT 3.50/08/180 1.5SN BK RL

Weidmüller Interface GmbH & Co. KG
 Klingenbergstraße 26
 D-32758 Detmold
 Germany

www.weidmueller.com

Technical data

Test: Clampable cross section	Standard	DIN EN 60999-1 section 7 and 9.1 / 12.00, DIN EN 60947-1 section 8.2.4.5.1 / 12.02	
	Conductor type	Type of conductor and conductor cross-section	solid 0.14 mm ²
		Type of conductor and conductor cross-section	stranded 0.14 mm ²
		Type of conductor and conductor cross-section	solid 1.5 mm ²
		Type of conductor and conductor cross-section	stranded 1.5 mm ²
		Type of conductor and conductor cross-section	AWG 24/1
		Type of conductor and conductor cross-section	AWG 24/19
		Type of conductor and conductor cross-section	AWG 16/1
		Type of conductor and conductor cross-section	AWG 16/19
Evaluation	passed		
Test for damage to and accidental loosening of conductors	Standard	DIN EN 60999-1 section 9.4 / 12.00	
	Requirement	0.2 kg	
	Conductor type	Type of conductor and conductor cross-section	AWG 24/1
		Type of conductor and conductor cross-section	AWG 24/19
	Evaluation	passed	
	Requirement	0.3 kg	
	Conductor type	Type of conductor and conductor cross-section	stranded 0.25 mm ²
		Type of conductor and conductor cross-section	solid 0.5 mm ²
	Evaluation	passed	
	Requirement	0.4 kg	
Conductor type	Type of conductor and conductor cross-section	solid 1.5 mm ²	
	Type of conductor and conductor cross-section	stranded 1.5 mm ²	
	Type of conductor and conductor cross-section	AWG 16/1	
	Type of conductor and conductor cross-section	AWG 16/19	
Evaluation	passed		

LSF-SMT 3.50/08/180 1.5SN BK RL

Weidmüller Interface GmbH & Co. KG
 Klingenbergstraße 26
 D-32758 Detmold
 Germany

www.weidmueller.com

Technical data

Pull-out test	Standard	DIN EN 60999-1 section 9.5 / 12.00		
	Requirement	≥10 N		
	Conductor type	Type of conductor and conductor cross-section	AWG 24/1	
		Type of conductor and conductor cross-section	AWG 24/19	
	Evaluation	passed		
	Requirement	≥20 N		
	Conductor type	Type of conductor and conductor cross-section	stranded 0.25 mm ²	
		Type of conductor and conductor cross-section	H05V-U0.5	
	Evaluation	passed		
	Requirement	≥40 N		
	Conductor type	Type of conductor and conductor cross-section	H07V-U1.5	
		Type of conductor and conductor cross-section	H07V-K1.5	
		Type of conductor and conductor cross-section	AWG 16/1	
		Type of conductor and conductor cross-section	AWG 16/19	
	Evaluation	passed		

Classifications

ETIM 6.0	EC002643	ETIM 7.0	EC002643
ETIM 8.0	EC002643	ECLASS 9.0	27-44-04-01
ECLASS 9.1	27-44-04-01	ECLASS 10.0	27-44-04-01
ECLASS 11.0	27-46-01-01	ECLASS 12.0	27-46-01-01

LSF-SMT 3.50/08/180 1.5SN BK RL

Weidmüller Interface GmbH & Co. KG

Klingenbergstraße 26

D-32758 Detmold

Germany

www.weidmueller.com

Technical data

Important note

IPC conformity	Conformity: The products are developed, manufactured and delivered according international recognized standards and norms and comply with the assured properties in the data sheet resp. fulfill decorative properties in accordance with IPC-A-610 "Class 2". Further claims on the products can be evaluated on request.
Notes	<ul style="list-style-type: none"> • Additional push button colours on request • Operating force of slider max. 40 N • Rated current related to rated cross-section & min. No. of poles. • Wire end ferrule with plastic collar to DIN 46228/4 • Wire end ferrule without plastic collar to DIN 46228/1 • P on drawing = pitch • Rated data refer only to the component itself. Clearance and creepage distances to other components are to be designed in accordance with the relevant application standards. • Crimping shape "A" for wire end ferrules with PZ 6/5 crimping tool recommended. • Long term storage of the product with average temperature of 50 °C and average humidity 70%, 36 months

Approvals

Approvals



ROHS	Conform
UL File Number Search	UL Website
Certificate No. (cURus)	E60693

Downloads

Approval/Certificate/Document of Conformity	Declaration of the Manufacturer
Engineering Data	CAD data – STEP
Engineering Data	WSCAD
Catalogues	Catalogues in PDF-format
Brochures	FL DRIVES EN FL ANALO.SIGN.CONV. EN MB SMT EN FL DRIVES DE MB DEVICE MANUF. EN FL BUILDING SAFETY EN FL APPL LED LIGHTING EN FLIndustr.CONTROLS EN FL MACHINE SAFETY EN FL HEATING ELECTR EN FL APPL INVERTER EN FL_BASE_STATION_EN FL ELEVATOR EN FL POWER SUPPLY EN FL 72H SAMPLE SER EN PO OMNIMATE EN PO OMNIMATE EN
White paper surface mount technology	Download Whitepaper

Creation date February 2, 2023 11:42:13 AM CET

Catalogue status 24.01.2023 / We reserve the right to make technical changes.

7

LSF-SMT 3.50/08/180 1.5SN BK RL

Weidmüller Interface GmbH & Co. KG
 Klingenbergstraße 26
 D-32758 Detmold
 Germany

www.weidmueller.com

Drawings

Dimensional drawing

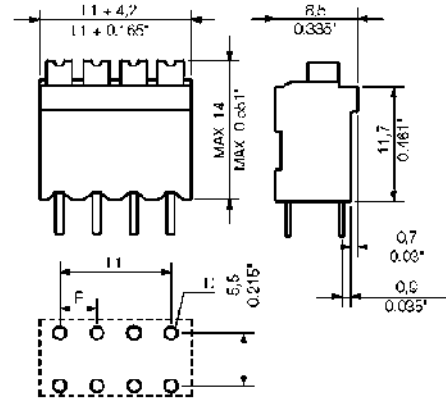

Graph

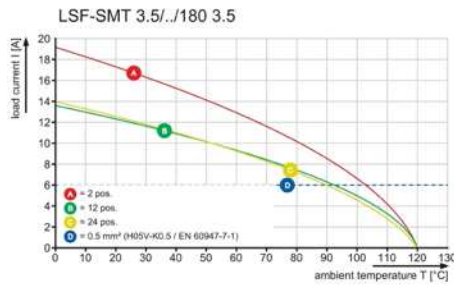

Graph

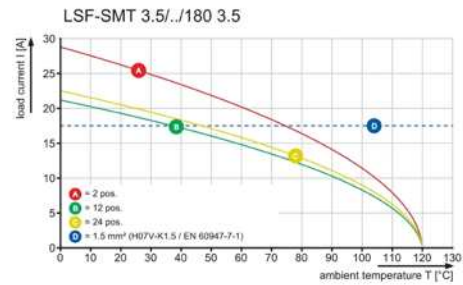

Dimensional drawing

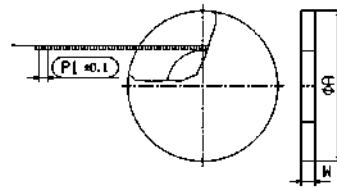

Dimensional drawing

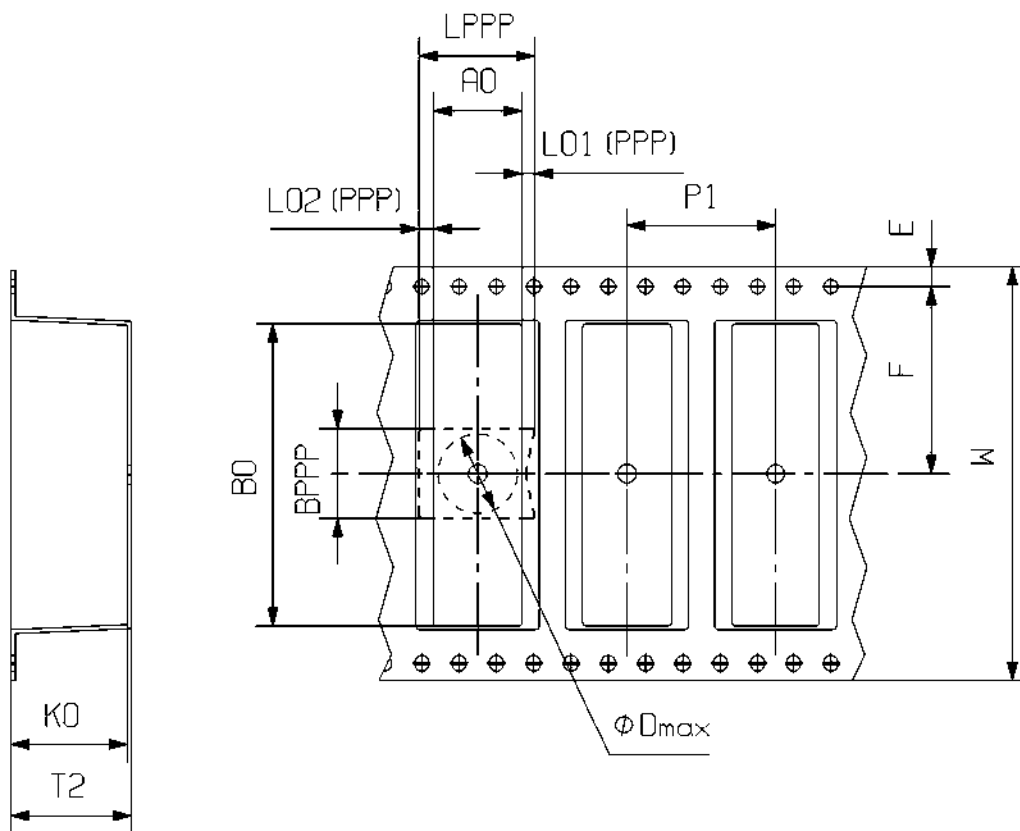

The reproduction, distribution and utilization of this document as well as the communication of its contents to others without explicit authorization is prohibited. Offenders will be held liable for the payment of damages. Weidmüller exclusively reserves the right to file for patents, utility models or designs.

© Weidmüller Interface GmbH & Co. KG

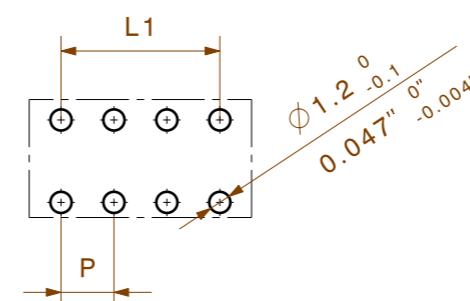
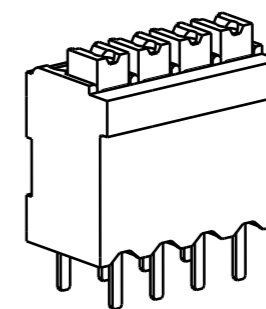
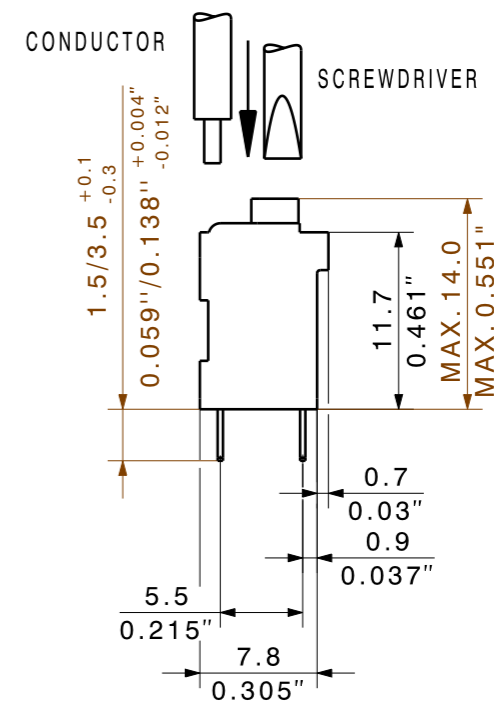
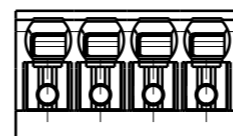
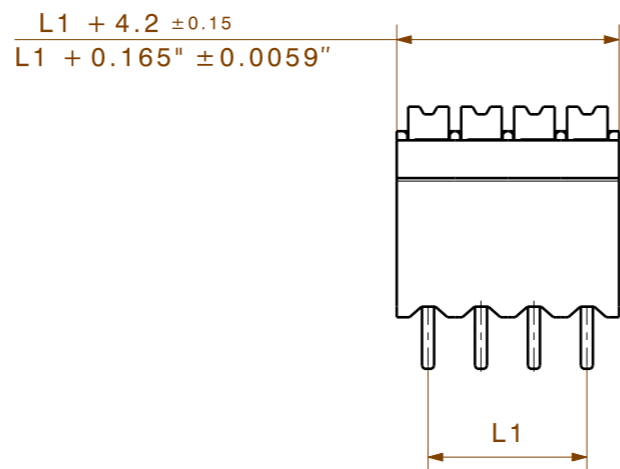

HOLE PATTERN

P=3.50

SHOWN: LSF-SMT 3.50/04/180

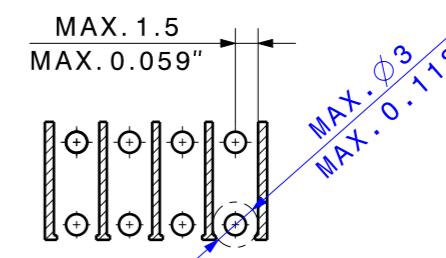

PASTE-FREE AREA

24	80,50	3,169
23	77,00	3,031
22	73,50	2,894
21	70,00	2,756
20	66,50	2,618
19	63,00	2,480
18	59,50	2,343
17	56,00	2,205
16	52,50	2,067
15	49,00	1,929
14	45,50	1,791
13	42,00	1,654
12	38,50	1,516
11	35,00	1,378
10	31,50	1,240
9	28,00	1,102
8	24,50	0,965
7	21,00	0,827
6	17,50	0,689
5	14,00	0,551
4	10,50	0,413
3	7,00	0,276
2	3,50	0,138
n	L1 [mm]	L1 [Inch]

For the mounting on PCBs, it should be noted that the rated data relates only to the PCB components alone. The necessary creepage and clearance paths must be observed in the relevant equipment standards in accordance with IEC 664 / VDE 0110. The current-carrying capacity and pitch tolerance is to be determined according to DIN IEC 326 part 3.

Weidmüller PCB components are rated in accordance with the DIN EN 61984 standard, and are valid for its field of application. If the components are used in accordance with the intended purpose, the components will meet all requirements with respect to the occurring of electrical, mechanical, thermic and corrosive stress.

	DIN ISO 2768-m	98688/5 23.10.17 HELIS_MA 00			Cat.no.: .
	Modification	Date Name			3 34084 15 Drawing no. Issue no. Sheet 01 of 07 sheets
	Scale: 5/1	Drawn	22.06.2004 SEIDEL_T	LSF-SMT .../.../180...TU LEITERPLATTENKLEMME PCB TERMINAL	Product file: LSF-SMT 7358
Supersedes: .	Responsible	Checked	01.11.2017 HELIS_MA		
	Approved	HECKERT_M			

Recommended wave soldering profiles

Weidmüller Interface GmbH & Co. KG
 Klängenbergstraße 16
 D-32758 Detmold
 Germany
 Fon: +49 5231 14-0
 Fax: +49 5231 14-292083
 www.weidmueller.com

Single Wave:

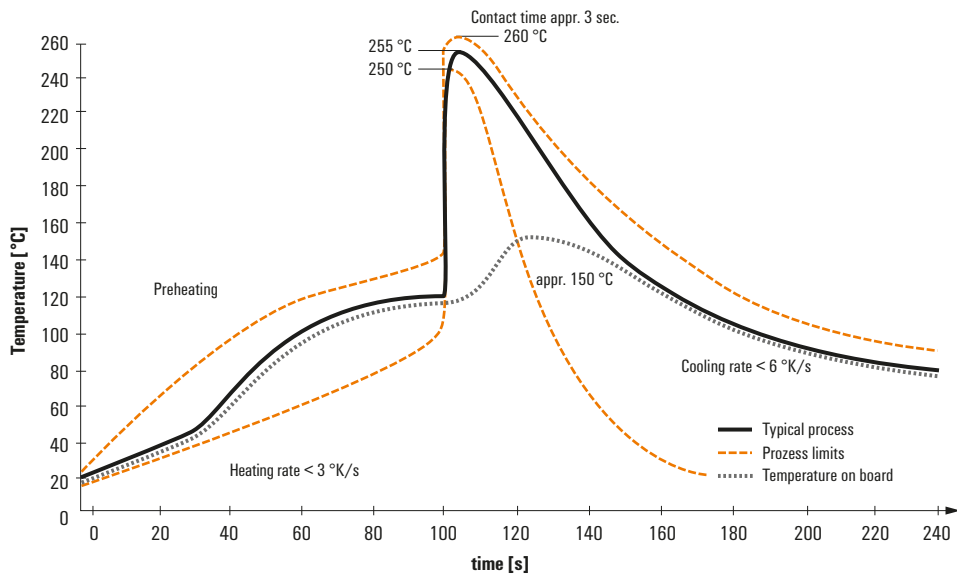

Double Wave:

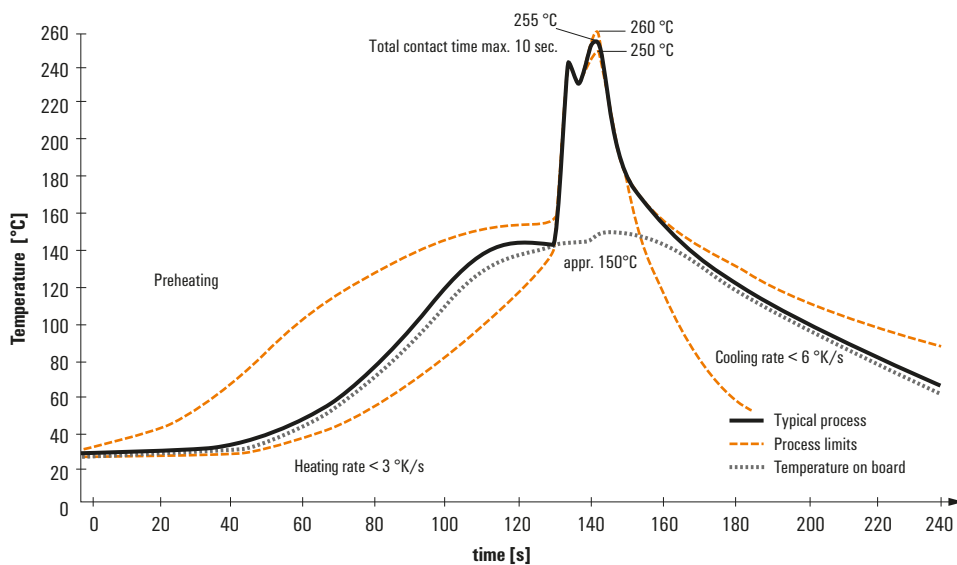

Wave soldering profiles

Wired connection elements should be processed in accordance with the DIN EN 61760-1 standard. We have included two recommendations for practical wave soldering profiles, with which Weidmüller PCB terminals and connectors are qualified.

When choosing a suitable profile for your application, the following factors also need to be considered:

- PCB thickness
- Proportion of Cu in the layers
- Single/double-sided assembly
- Product range
- Heating and cooling rates

The single and double wave profiles each indicate the recommended operating range, including the maximum soldering temperature of 260°C. In practice, the maximum soldering temperature is quite often well below the above maximum profile.

Recommended reflow soldering profile

Weidmüller Interface GmbH & Co. KG
 Klingenbergstraße 16
 D-32758 Detmold
 Germany
 Fon: +49 5231 14-0
 Fax: +49 5231 14-292083
 www.weidmueller.com

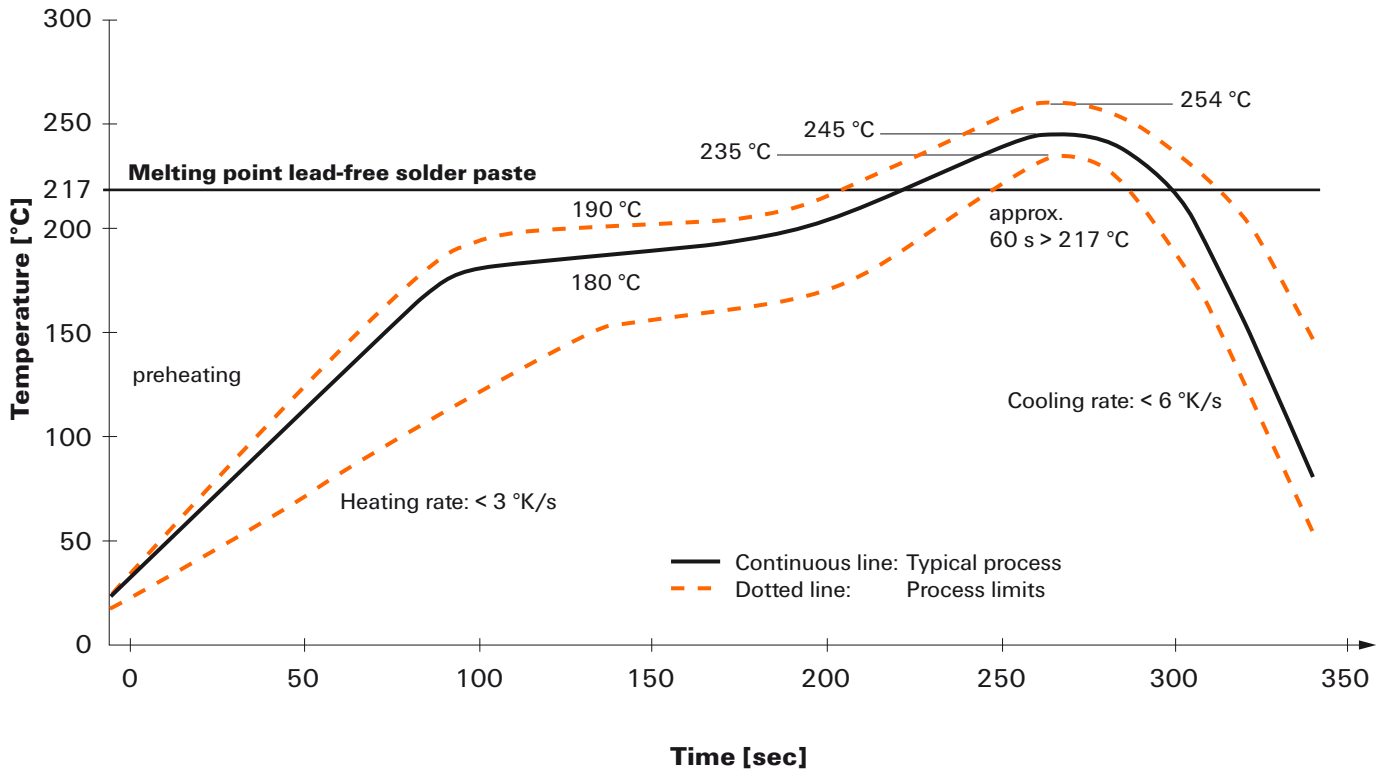

Reflow soldering profile

The perfect soldering profile for SMT Surface Mount Technology is one the most exiting question in SMT production. But there are more than one correct answer: The diagram of temperature-on-time is related to processing features of solder paste and to maximum load of components.

We have to consider the following parameters:

- Time for pre heating
- Maximum temperature
- Time above melting point
- Time for cooling
- Maximum heating rate
- Maximum cooling rate

We recommend a typical solder profile with associated process limits. With preheating components and board are prepared smoothly for the solder phase. Heating rate is typically $\leq +3\text{K/s}$. In parallel the solder paste is ‚activated‘. The time above melting point of 217°C the paste gets liquid and components and boards begin to connect. The maximum temperature of 245°C to 254°C should stay between 10 and 40 seconds. In the cooling phase at $\geq -6\text{K/s}$ solder is cured. Board and components cool down while avoiding cold cracks.