

# FKCVW 2,5/ 5-ST-5,08 - PCB connector

1873689

<https://www.phoenixcontact.com/de/produkte/1873689>

Please be informed that the data shown in this PDF document is generated from our online catalog. Please find the complete data in the user documentation. Our general terms of use for downloads are valid.



PCB connector, nominal cross section: 2.5 mm<sup>2</sup>, color: green, nominal current: 12 A, rated voltage (III/2): 320 V, contact surface: Tin, contact connection type: Socket, number of potentials: 5, number of rows: 1, number of positions: 5, number of connections: 5, product range: FKCVW 2,5/..-ST, pitch: 5.08 mm, connection method: Push-in spring connection, conductor/PCB connection direction: -90 °, locking clip: - Locking clip, plug-in system: COMBICON MSTB 2,5, locking: without, mounting: without, type of packaging: packed in cardboard

## Your advantages

- Time saving push-in connection, tools not required
- Intuitive use through colour coded actuation lever
- Quick and convenient testing using integrated test option
- Can be combined with the MSTB 2,5 range

## Commercial data

Item number	1873689
Packing unit	50 pc
Minimum order quantity	50 pc
Sales key	E1 - Leiterplattenanschl.
Product key	AACFIC
Catalog page	Page 281 (C-1-2013)
GTIN	4017918143077
Weight per piece (including packing)	9,384 g
Weight per piece (excluding packing)	8,803 g
Customs tariff number	85366990
Country of origin	SK

# FKCVW 2,5/ 5-ST-5,08 - PCB connector



1873689

<https://www.phoenixcontact.com/de/produkte/1873689>

## Technical data

### Product properties

Type	Standard
Product line	COMBICON Connectors M
Product type	PCB connector
Product family	FKCVW 2,5/..-ST
Number of positions	5
Pitch	5.08 mm
Number of connections	5
Number of rows	1
Mounting flange	without
Number of potentials	5

### Electrical properties

Nominal current $I_N$	12 A
Nominal voltage $U_N$	320 V
Degree of pollution	3
Contact resistance	1 mΩ
Rated voltage (III/3)	250 V
Rated surge voltage (III/3)	4 kV
Rated voltage (III/2)	320 V
Rated surge voltage (III/2)	4 kV
Rated voltage (II/2)	630 V
Rated surge voltage (II/2)	4 kV

### Connection data

#### Connection technology

Type	Standard
Connector system	COMBICON MSTB 2,5
Nominal cross section	2.5 mm <sup>2</sup>
Contact connection type	Socket

#### Interlock

Locking type	without
Mounting flange	without

#### Conductor connection

Connection method	Push-in spring connection
Conductor/PCB connection direction	-90 °
Conductor cross section rigid	0.2 mm <sup>2</sup> ... 2.5 mm <sup>2</sup>
Conductor cross section flexible	0.2 mm <sup>2</sup> ... 2.5 mm <sup>2</sup>
Conductor cross section AWG	24 ... 12
Conductor cross section flexible, with ferrule without plastic	0.25 mm <sup>2</sup> ... 2.5 mm <sup>2</sup>

# FKCVW 2,5/ 5-ST-5,08 - PCB connector

1873689

<https://www.phoenixcontact.com/de/produkte/1873689>

sleeve	
Conductor cross section, flexible, with ferrule, with plastic sleeve	0.25 mm <sup>2</sup> ... 2.5 mm <sup>2</sup>
2 conductors with the same cross section, flexible, with TWIN ferrule with plastic sleeve	0.5 mm <sup>2</sup> ... 1.5 mm <sup>2</sup>
Cylindrical gauge a x b / diameter	2.8 mm x 2.0 mm / 2.3 mm
Stripping length	10 mm

## Material specifications

### Material data - contact

Note	WEEE/RoHS-compliant, free of whiskers according to IEC 60068-2-82/JEDEC JESD 201
Contact material	Cu alloy
Surface characteristics	hot-dip tin-plated
Metal surface terminal point (top layer)	Tin (4 - 8 µm Sn)
Metal surface contact area (top layer)	Tin (4 - 8 µm Sn)

### Material data - housing

Color (Housing)	green (6021)
Insulating material	PA
Insulating material group	I
CTI according to IEC 60112	600
Flammability rating according to UL 94	V0
Glow wire flammability index GWFI according to EN 60695-2-12	850
Glow wire ignition temperature GWIT according to EN 60695-2-13	775
Temperature for the ball pressure test according to EN 60695-10-2	125 °C

### Material data – actuating element

Color (Actuating element)	orange (2003)
Insulating material	PBT
Insulating material group	I
CTI according to IEC 60112	600
Flammability rating according to UL 94	V0

## Dimensions

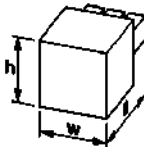
Dimensional drawing	
Pitch	5.08 mm
Width [w]	26.02 mm
Height [h]	19.2 mm
Length [l]	26.6 mm

# FKCVW 2,5/ 5-ST-5,08 - PCB connector



1873689

<https://www.phoenixcontact.com/de/produkte/1873689>

## Mounting

Connection method	Push-in spring connection
-------------------	---------------------------

## Notes

Notes on operation	In accordance with IEC 61984, COMBICON connectors have no switching power (COC). During designated use, they must not be plugged in or disconnected when carrying voltage or under load.
--------------------	--

## Mechanical tests

### Conductor connection

Specification	IEC 60999-1:1999-11
Result	Test passed

### Test for conductor damage and slackening

Specification	IEC 60999-1:1999-11
Result	Test passed

### Repeated connection and disconnection

Specification	IEC 60999-1:1999-11
Result	Test passed

### Pull-out test

Specification	IEC 60999-1:1999-11
Conductor cross section/conductor type/tractive force setpoint/actual value	0.2 mm <sup>2</sup> / solid / > 10 N
	0.2 mm <sup>2</sup> / flexible / > 10 N
	2.5 mm <sup>2</sup> / solid / > 50 N
	2.5 mm <sup>2</sup> / flexible / > 50 N

### Insertion and withdrawal forces

Result	Test passed
No. of cycles	25
Insertion strength per pos. approx.	8 N
Withdraw strength per pos. approx.	6 N

### Resistance of inscriptions

Specification	IEC 60068-2-70:1995-12
Result	Test passed

### Polarization and coding

Specification	IEC 60512-13-5:2006-02
Result	Test passed

### Visual inspection

Specification	IEC 60512-1-1:2002-02
Result	Test passed

### Dimension check

# FKCVW 2,5/ 5-ST-5,08 - PCB connector



1873689

<https://www.phoenixcontact.com/de/produkte/1873689>

Specification	IEC 60512-1-2:2002-02
Result	Test passed

## Environmental and real-life conditions

### Vibration test

Specification	IEC 60068-2-6:2007-12
Frequency	10 - 150 - 10 Hz
Sweep speed	1 octave/min
Amplitude	0.35 mm (10 Hz ... 60.1 Hz)
Sweep speed	5g (60.1 Hz ... 150 Hz)
Test duration per axis	2.5 h

### Durability test

Specification	IEC 60512-9-1:2010-03
Impulse withstand voltage at sea level	4.8 kV
Contact resistance R <sub>1</sub>	1 mΩ
Contact resistance R <sub>2</sub>	1.1 mΩ
Insertion/withdrawal cycles	25
Insulation resistance, neighboring positions	> 5 MΩ

### Climatic test

Specification	ISO 6988:1985-02
Corrosive stress	0.2 dm <sup>3</sup> SO <sub>2</sub> on 300 dm <sup>3</sup> /40 °C/1 cycle
Thermal stress	100 °C/168 h
Power-frequency withstand voltage	2.21 kV

### Ambient conditions

Ambient temperature (operation)	-40 °C ... 100 °C (dependent on the derating curve)
Ambient temperature (storage/transport)	-40 °C ... 70 °C
Relative humidity (storage/transport)	30 % ... 70 %
Ambient temperature (assembly)	-5 °C ... 100 °C

## Electrical tests

### Thermal test | Test group C

Specification	IEC 60512-5-1:2002-02
Tested number of positions	16

### Insulation resistance

Specification	IEC 60512-3-1:2002-02
Insulation resistance, neighboring positions	> 5 MΩ

### Air clearances and creepage distances |

Specification	IEC 60664-1:2007-04
Insulating material group	I
Comparative tracking index (IEC 60112)	CTI 600

# FKCVW 2,5/ 5-ST-5,08 - PCB connector



1873689

<https://www.phoenixcontact.com/de/produkte/1873689>

Rated insulation voltage (III/3)	250 V
Rated surge voltage (III/3)	4 kV
minimum clearance value - non-homogenous field (III/3)	3 mm
minimum creepage distance (III/3)	3.2 mm
Rated insulation voltage (III/2)	320 V
Rated surge voltage (III/2)	4 kV
minimum clearance value - non-homogenous field (III/2)	3 mm
minimum creepage distance (III/2)	1.6 mm
Rated insulation voltage (II/2)	630 V
Rated surge voltage (II/2)	4 kV
minimum clearance value - non-homogenous field (II/2)	3 mm
minimum creepage distance (II/2)	3.2 mm

## Packaging specifications

Type of packaging	packed in cardboard
-------------------	---------------------

## Drawings

Diagram

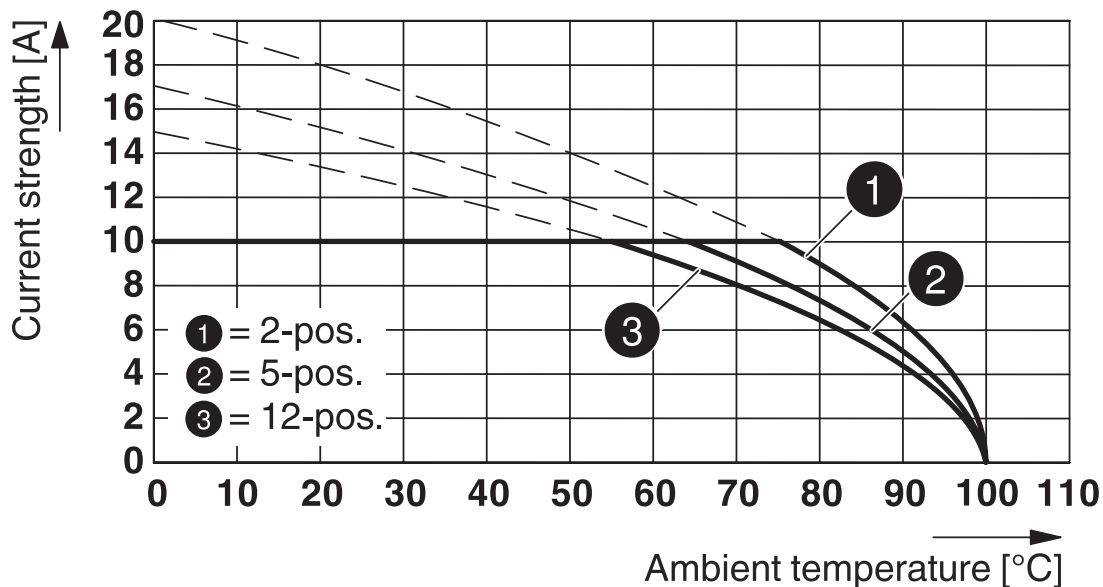

Type:FKCV(R/W) 2,5/...-ST-5,08 with MDSTBV 2,5/...-G-5,08

Diagram

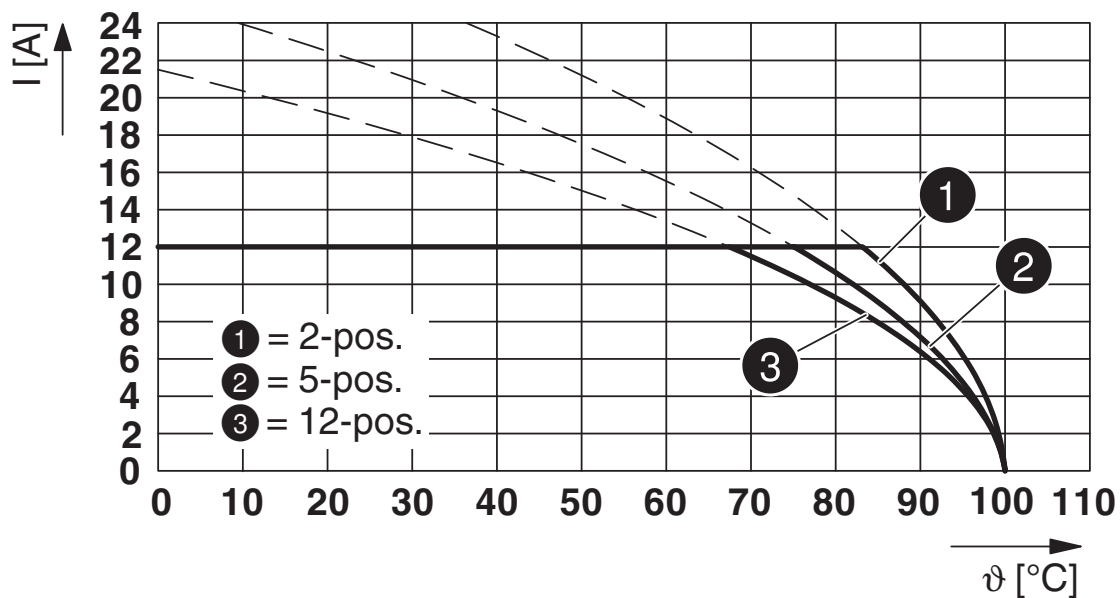

Type: FKCV(W/R) 2,5/...-ST-5,08 with CC 2,5/...-G-5,08 P...THR

1873689

<https://www.phoenixcontact.com/de/produkte/1873689>

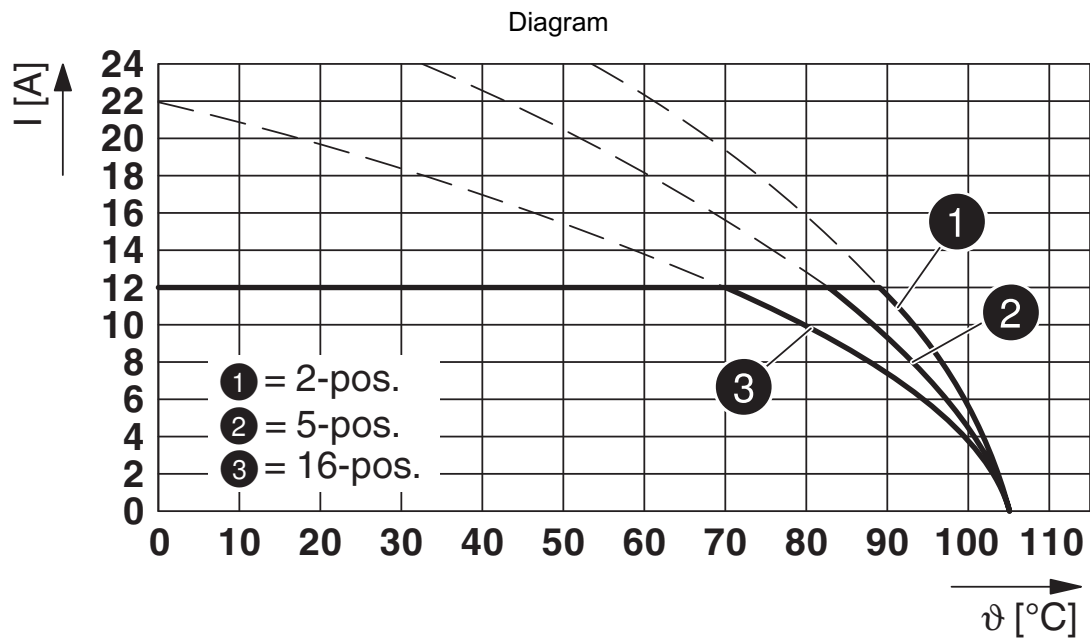

Type: FKCVW 2,5/...-ST-5,08 with MSTBW 2,5/...-G-5,08

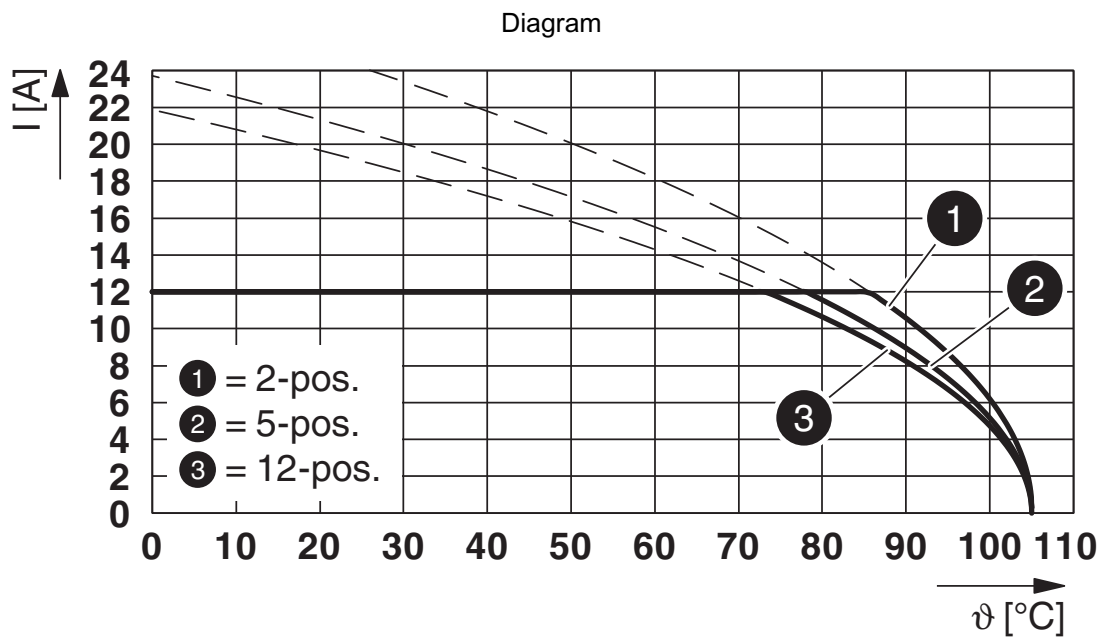

Type: FKCVW 2,5/...-ST-5,08 with CCV 2,5/...-G-5,08 P26THR

1873689

<https://www.phoenixcontact.com/de/produkte/1873689>

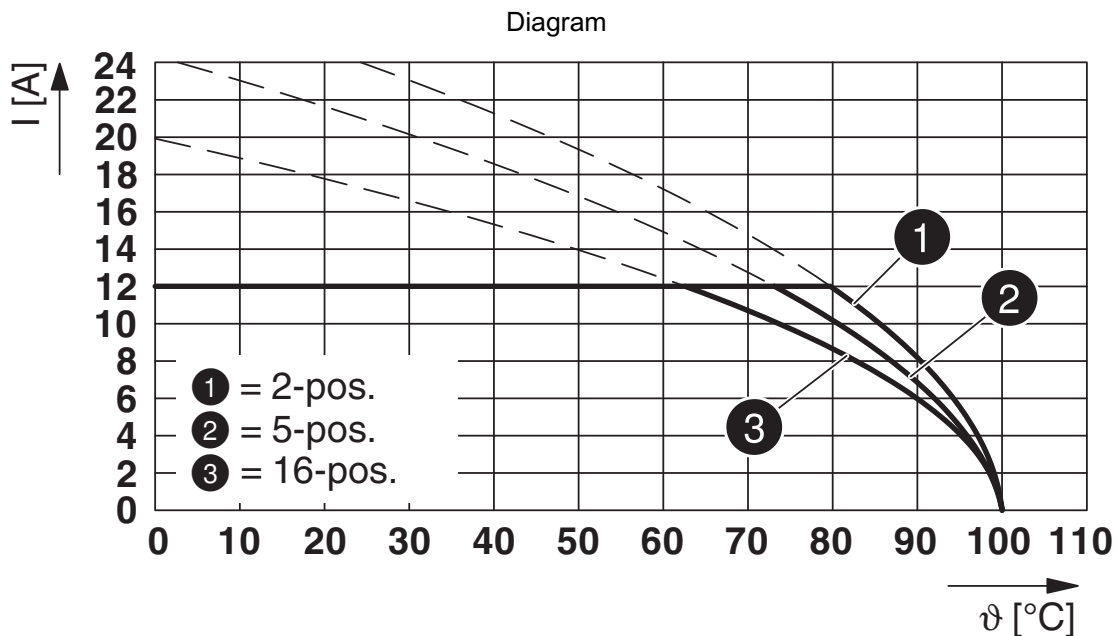

Type: FKCV(W/R) 2,5/...-ST-5,08 with SMSTBA 2,5/...-G-5,08

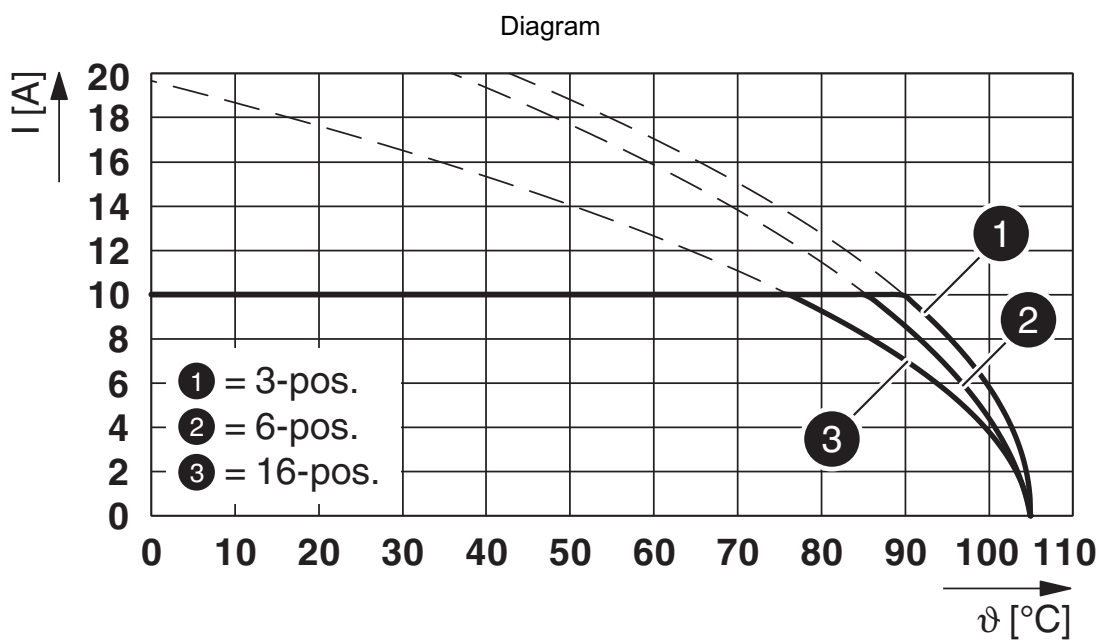

Type: FKCVW 2,5/...-ST-5,08 with MDSTBV 2,5/...-G1-5,08

# FKCVW 2,5/ 5-ST-5,08 - PCB connector



1873689

<https://www.phoenixcontact.com/de/produkte/1873689>

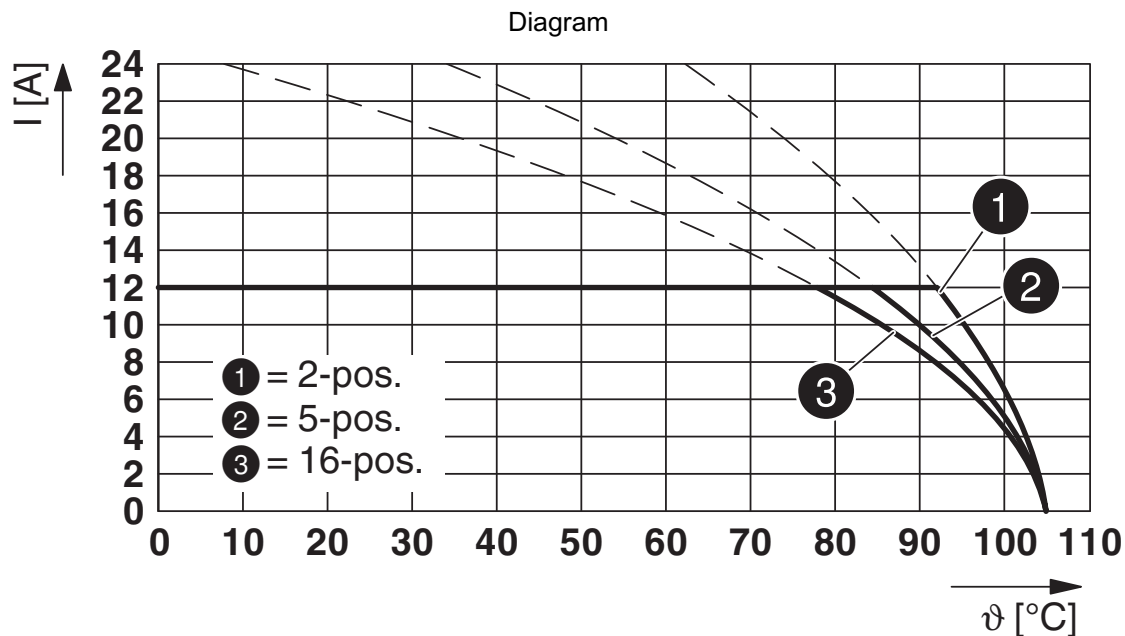

Type: FKCVW 2,5/...-ST-5,08 with MSTBA 2,5/...-G-5,08

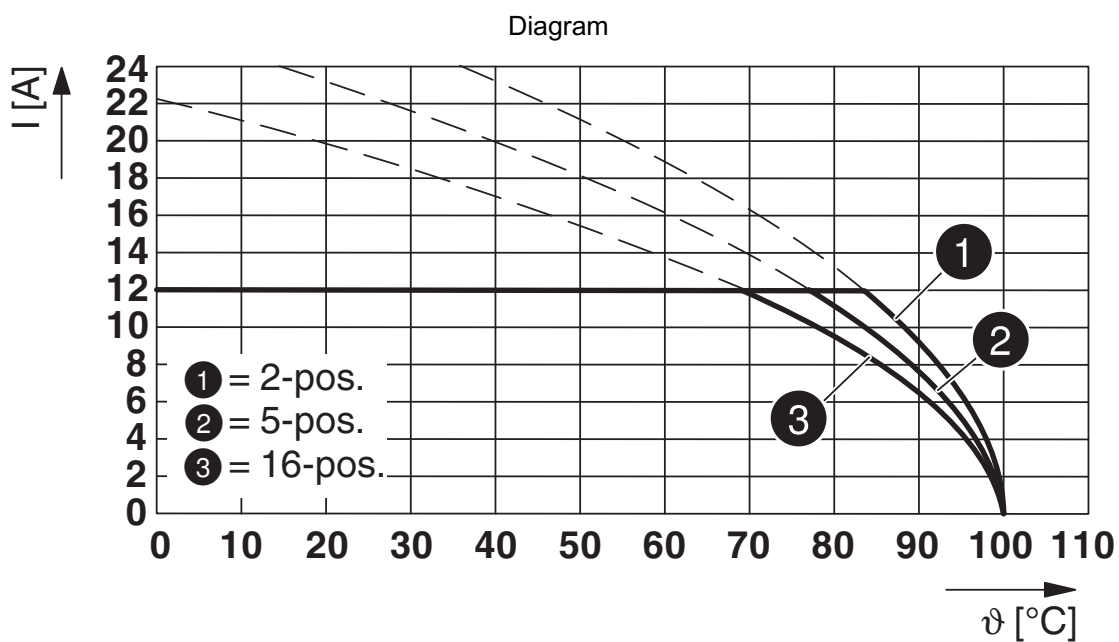

Type: FKCV(W/R) 2,5/...-ST-5,08 with MSTB 2,5/...-G-5,08

# FKCVW 2,5/ 5-ST-5,08 - PCB connector



1873689

<https://www.phoenixcontact.com/de/produkte/1873689>

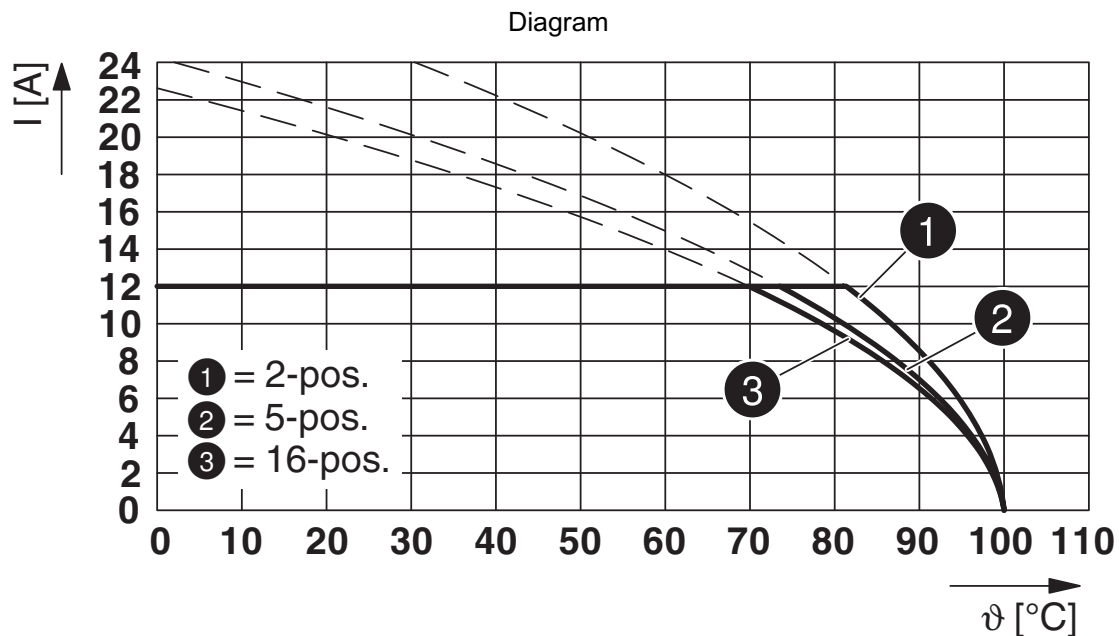

Type: FKCV(W/R) 2,5/...-ST-5,08 with SMSTB 2,5/...-G-5,08

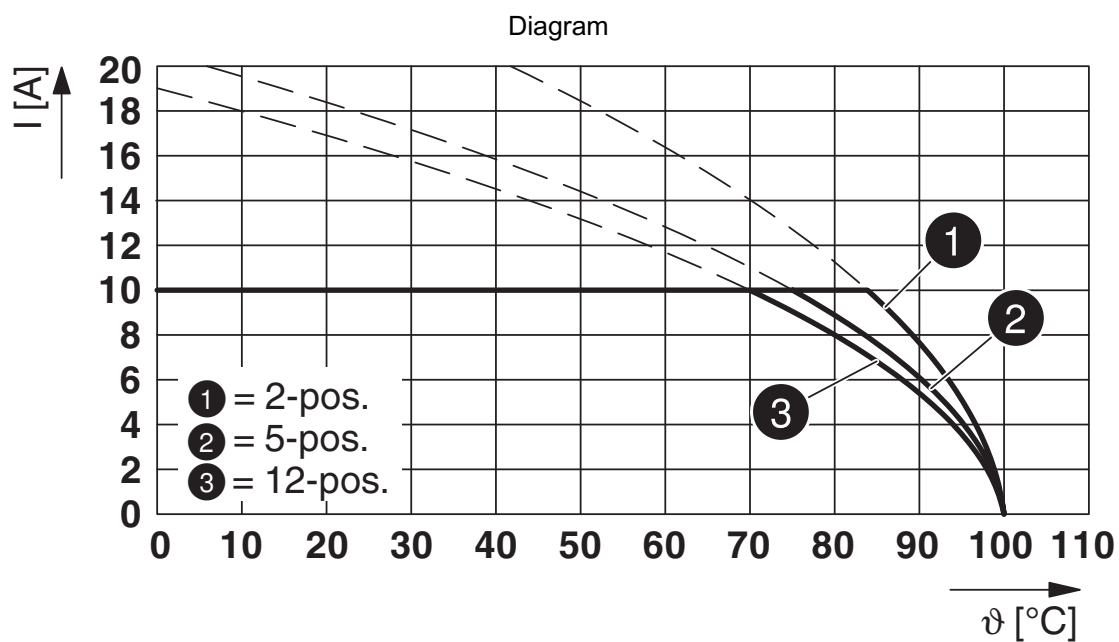

Type: FKCV(W/R) 2,5/...-ST-5,08 with MDSTBA 2,5/...-G-5,08

# FKCVW 2,5/ 5-ST-5,08 - PCB connector

1873689

<https://www.phoenixcontact.com/de/produkte/1873689>

Dimensional drawing

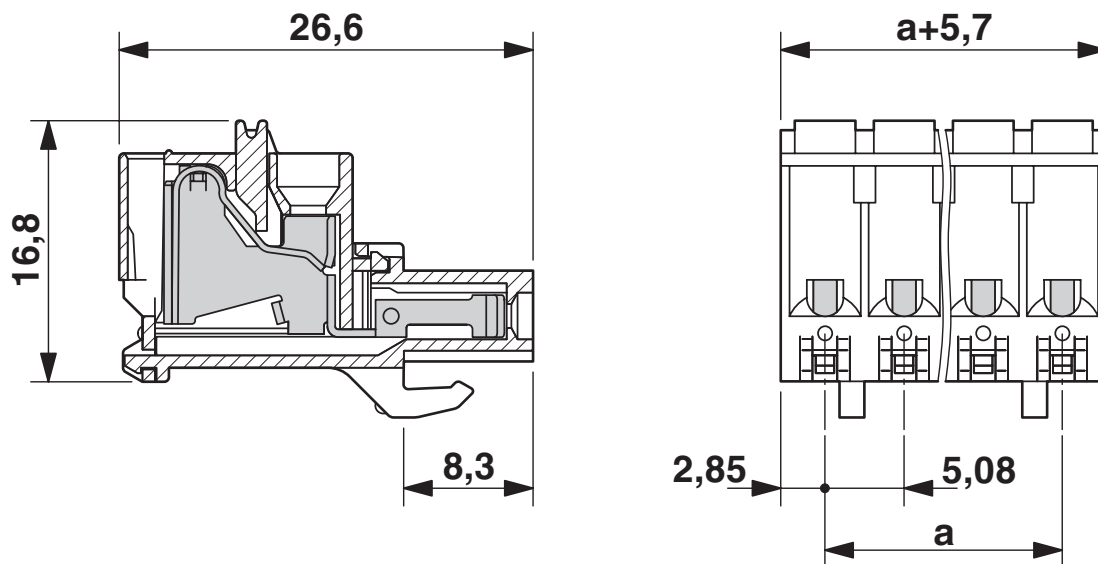

Diagram

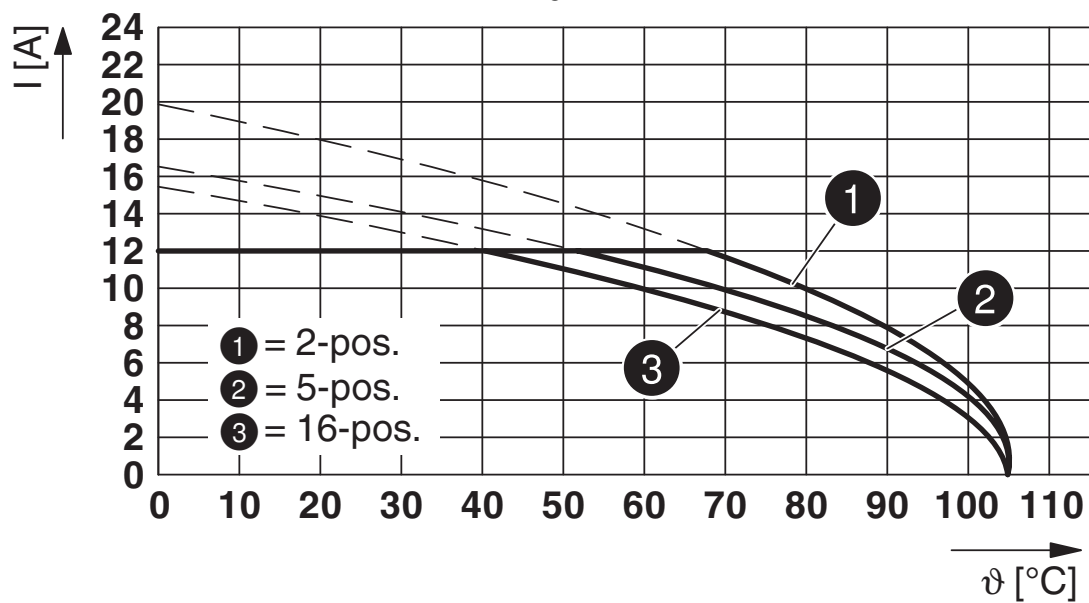

Type: FKCVW 2,5/...-ST-5,08 with MSTBVA 2,5/...-G-5,08

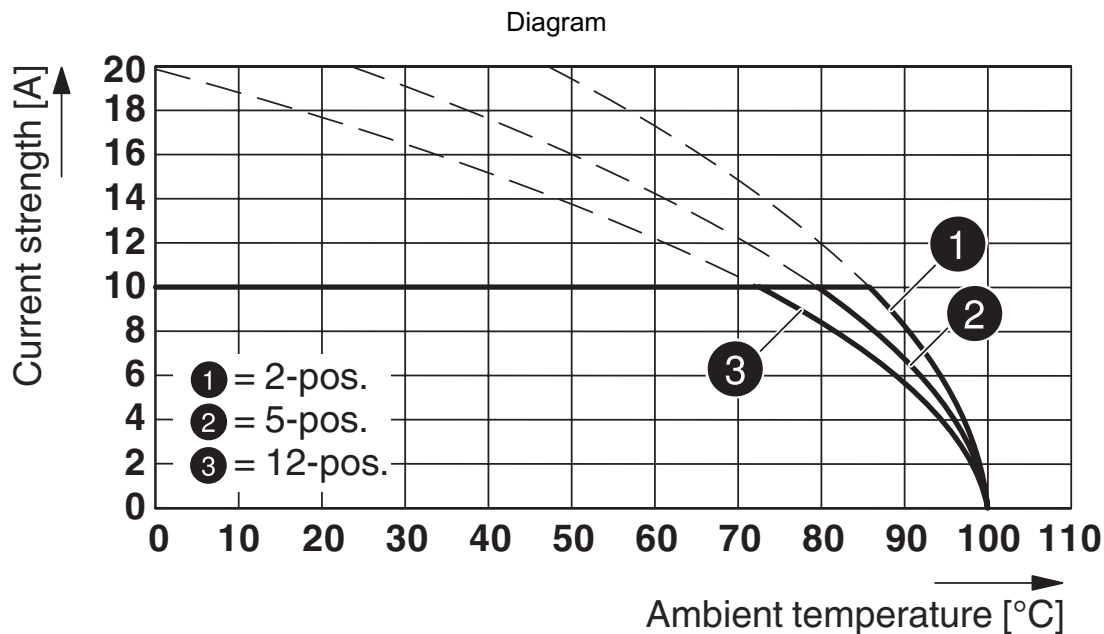

Type:FKCV(R/W) 2,5/...-ST-5,08 with MDSTB 2,5/...-G-5,08

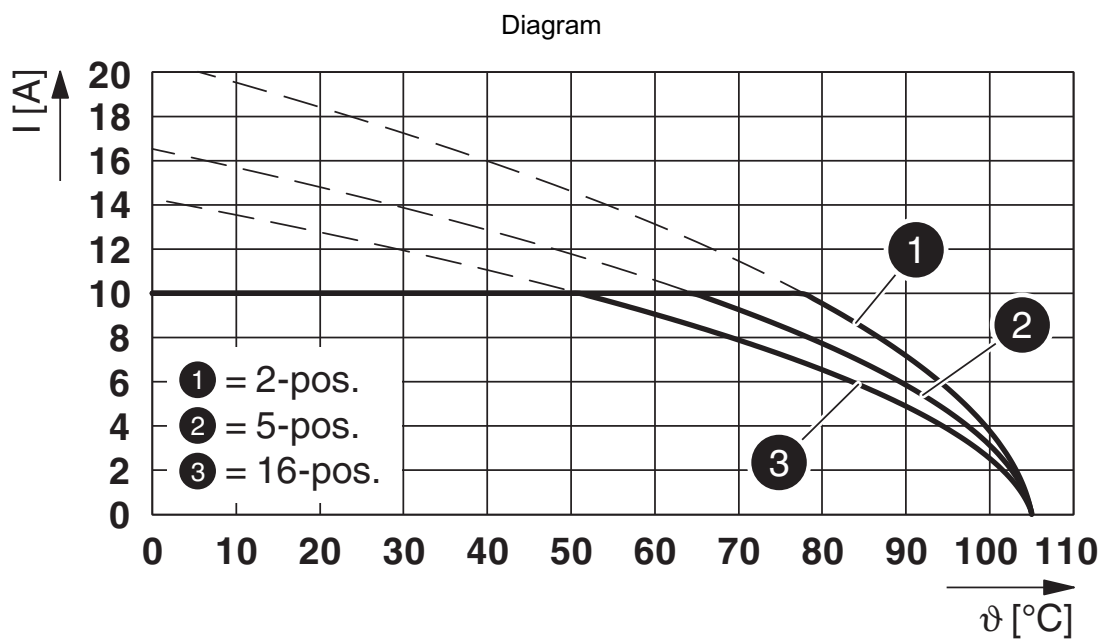

Type: FKCVW 2,5/...-ST-5,08 with MDSTBVA 2,5/...-G-5,08

# FKCVW 2,5/ 5-ST-5,08 - PCB connector



1873689

<https://www.phoenixcontact.com/de/produkte/1873689>

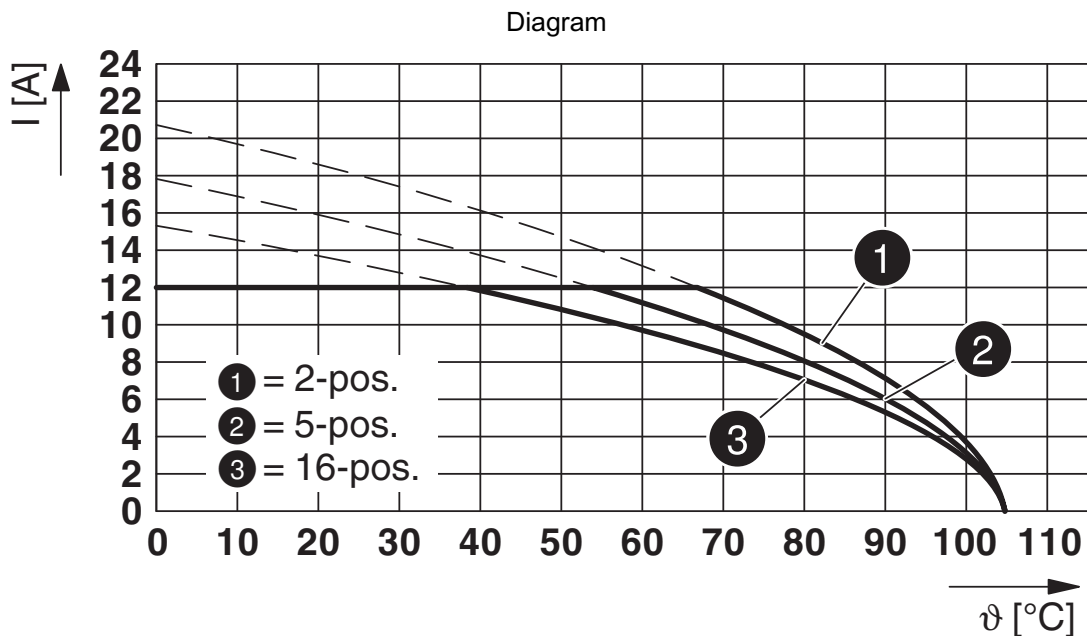

Type: FKCVW 2,5/...-ST-5,08 with MSTBV 2,5/...-G-5,08

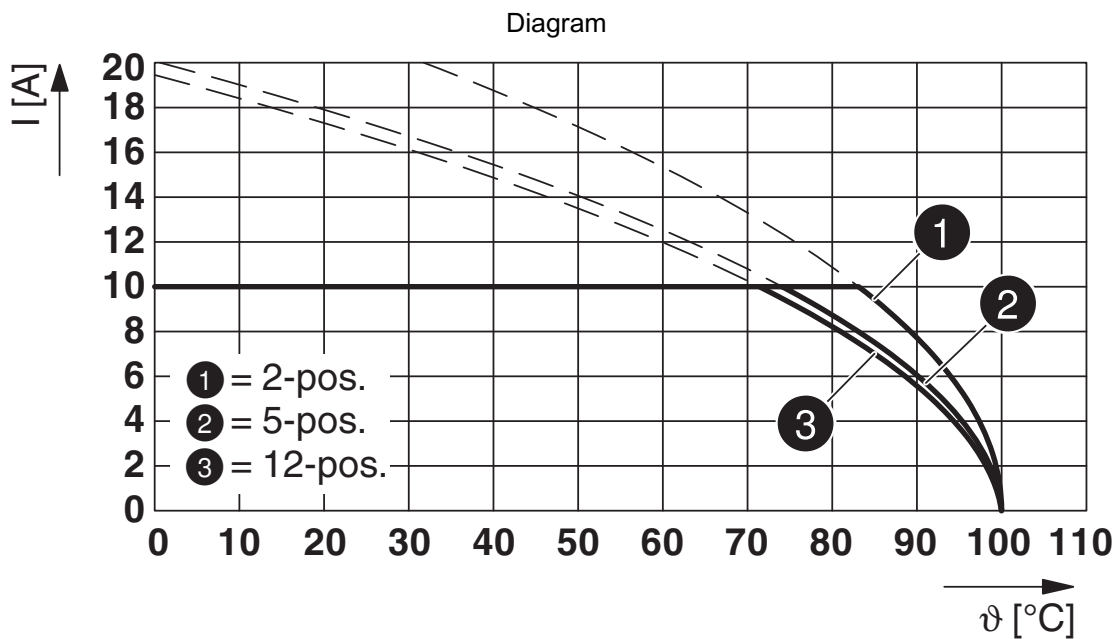

Type: FKCV(W/R) 2,5/...-ST-5,08 with MDSTBW 2,5/...-G-5,08

# FKCVW 2,5/ 5-ST-5,08 - PCB connector



1873689

<https://www.phoenixcontact.com/de/produkte/1873689>

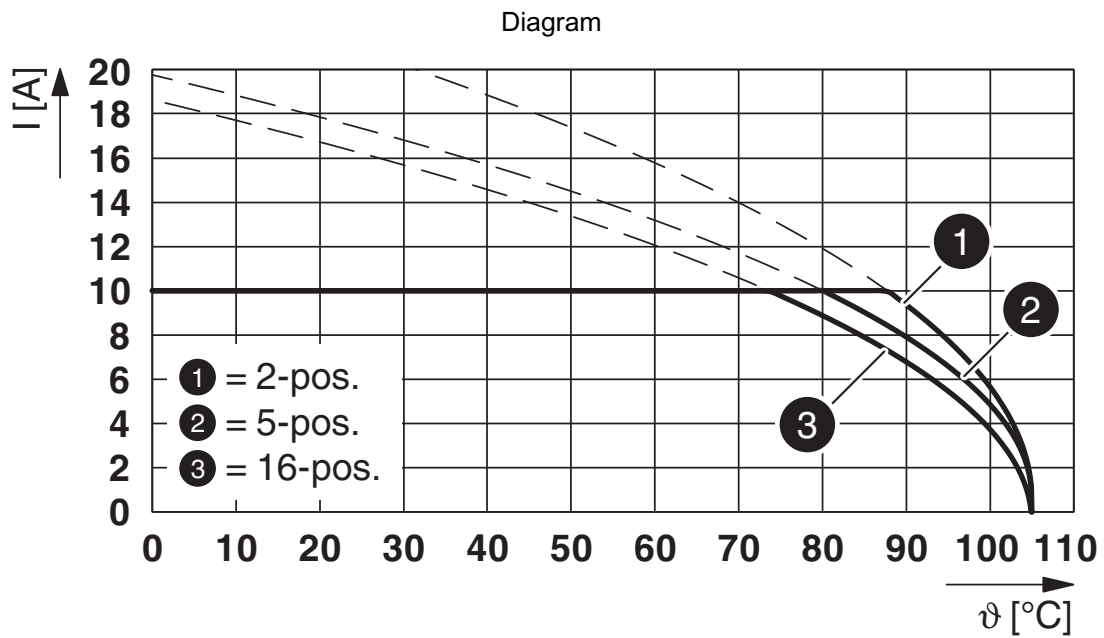

Type: FKCVW 2,5/...-ST-5,08 with MDSTB 2,5/...-G1-5,08

# FKCVW 2,5/ 5-ST-5,08 - PCB connector



1873689

<https://www.phoenixcontact.com/de/produkte/1873689>

## Approvals

To download certificates, visit the product detail page: <https://www.phoenixcontact.com/de/produkte/1873689>



**EAC**

Approval ID: B.01687



**cULus Recognized**

Approval ID: E60425-19931011

	Nominal voltage $U_N$	Nominal current $I_N$	Cross section AWG	Cross section $\text{mm}^2$
Use group B				
	300 V	10 A	26 - 12	-
Use group D				
	300 V	10 A	26 - 12	-



**VDE Zeichengenehmigung**

Approval ID: 40050694

	Nominal voltage $U_N$	Nominal current $I_N$	Cross section AWG	Cross section $\text{mm}^2$
	250 V	12 A	-	0.2 - 2.5

# FKCVW 2,5/ 5-ST-5,08 - PCB connector



1873689

<https://www.phoenixcontact.com/de/produkte/1873689>

## Classifications

### ECLASS

ECLASS-11.0	27460202
ECLASS-12.0	27460202
ECLASS-13.0	27460202

### ETIM

ETIM 8.0	EC002638
----------	----------

### UNSPSC

UNSPSC 21.0	39121400
-------------	----------

# FKCVW 2,5/ 5-ST-5,08 - PCB connector



1873689

<https://www.phoenixcontact.com/de/produkte/1873689>

## Environmental product compliance

China RoHS	Environmentally friendly use period: unlimited = EFUP-e
	No hazardous substances above threshold values

# FKCVW 2,5/ 5-ST-5,08 - PCB connector

1873689

<https://www.phoenixcontact.com/de/produkte/1873689>

## Accessories

### CP-MSTB - Coding profile

1734634

<https://www.phoenixcontact.com/de/produkte/1734634>

Coding profile, is inserted into the slot on the plug or inverted header, red insulating material



---

### STZ 4-FKC-5,08 - Strain relief

1876877

<https://www.phoenixcontact.com/de/produkte/1876877>

Strain relief for snapping into the latching chambers of the plugs, 4-pos.



# FKCVW 2,5/ 5-ST-5,08 - PCB connector

1873689

<https://www.phoenixcontact.com/de/produkte/1873689>

## STZ 8-FKC-5,08 - Strain relief

1876880

<https://www.phoenixcontact.com/de/produkte/1876880>



Strain relief for snapping into the latching chambers of the plug components, 8-pos.

---

## MPS-MT - Test plugs

0201744

<https://www.phoenixcontact.com/de/produkte/0201744>



Test plugs, with solder connection up to 1 mm<sup>2</sup> conductor cross section, number of positions: 1, color: gray

# FKCVW 2,5/ 5-ST-5,08 - PCB connector

1873689

<https://www.phoenixcontact.com/de/produkte/1873689>

## RPS - Reducing plug

0201647

<https://www.phoenixcontact.com/de/produkte/0201647>



Reducing plug, number of positions: 1, color: gray

---

## SZS 0,6X3,5 - Screwdriver

1205053

<https://www.phoenixcontact.com/de/produkte/1205053>



Actuation tool, for ST terminal blocks, insulated, also suitable for use as a bladed screwdriver, size: 0.6 x 3.5 x 100 mm, 2-component grip, with non-slip grip

# FKCVW 2,5/ 5-ST-5,08 - PCB connector

1873689

<https://www.phoenixcontact.com/de/produkte/1873689>

## SK 5,08/3,8:FORTL.ZAHLEN - Marker card

0804293

<https://www.phoenixcontact.com/de/produkte/0804293>



Marker card, white, labeled, horizontal: consecutive numbers 1 ... 10, 11 ... 20, etc. up to 91 ... (99)100, mounting type: adhesive, for terminal block width: 5.08 mm, lettering field size: 5.08 x 3.8 mm

---

## SK 5,08/3,8:UNBEDRUCKT - Marker card

0805412

<https://www.phoenixcontact.com/de/produkte/0805412>



Marker card, Din A4, white, unlabeled, can be labeled with: Marker pen: without print, mounting type: adhesive, for terminal block width: 5.08 mm, lettering field size: 5.08 x 3.8 mm, Number of individual labels: 1

## FKCVW 2,5/ 5-ST-5,08 - PCB connector

1873689

<https://www.phoenixcontact.com/de/produkte/1873689>



## MSTBW 2,5/ 5-G-5,08 - PCB header

1735853

<https://www.phoenixcontact.com/de/produkte/1735853>



PCB headers, nominal cross section: 2.5 mm<sup>2</sup>, color: green, nominal current: 12 A, rated voltage (III/2): 320 V, contact surface: Tin, contact connection type: Pin, number of potentials: 5, number of rows: 1, number of positions: 5, number of connections: 5, product range: MSTBW 2,5/..-G, pitch: 5.08 mm, mounting: Wave soldering, pin layout: Linear pinning, solder pin [P]: 3.5 mm, number of solder pins per potential: 1, plug-in system: COMBICON MSTB 2,5, Pin connector pattern alignment: Standard, locking: without, mounting: without, type of packaging: packed in cardboard

## MSTBVA 2,5/ 5-G-5,08 - PCB header

1755765

<https://www.phoenixcontact.com/de/produkte/1755765>

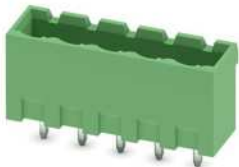

PCB headers, nominal cross section: 2.5 mm<sup>2</sup>, color: green, nominal current: 12 A, rated voltage (III/2): 320 V, contact surface: Tin, contact connection type: Pin, number of potentials: 5, number of rows: 1, number of positions: 5, number of connections: 5, product range: MSTBVA 2,5/..-G, pitch: 5.08 mm, mounting: Wave soldering, pin layout: Linear pinning, solder pin [P]: 3.9 mm, number of solder pins per potential: 1, plug-in system: COMBICON MSTB 2,5, Pin connector pattern alignment: Standard, locking: without, mounting: without, type of packaging: packed in cardboard

# FKCVW 2,5/ 5-ST-5,08 - PCB connector

1873689

<https://www.phoenixcontact.com/de/produkte/1873689>

## DFK-MSTBVA 2,5/ 5-G-5,08 - Feed-through header

1899168

<https://www.phoenixcontact.com/de/produkte/1899168>



Feed-through header, nominal cross section: 2.5 mm<sup>2</sup>, color: green, nominal current: 12 A, rated voltage (III/2): 320 V, contact surface: Tin, contact connection type: Pin, number of potentials: 5, number of rows: 1, number of positions: 5, number of connections: 5, product range: DFK-MSTBVA 2,5/..-G, pitch: 5.08 mm, mounting: Wave soldering, pin layout: Linear pinning, solder pin [P]: 3.9 mm, number of solder pins per potential: 1, plug-in system: COMBICON MSTB 2,5, Pin connector pattern alignment: Standard, locking: without, mounting: without, type of packaging: packed in cardboard

## CC 2,5/ 5-G-5,08 P26THR - PCB header

1954414

<https://www.phoenixcontact.com/de/produkte/1954414>



PCB headers, nominal cross section: 2.5 mm<sup>2</sup>, color: black, nominal current: 12 A, rated voltage (III/2): 320 V, contact surface: Tin, contact connection type: Pin, number of potentials: 5, number of rows: 1, number of positions: 5, number of connections: 5, product range: CC 2,5/..-G, pitch: 5.08 mm, mounting: THR soldering, pin layout: Linear pinning, solder pin [P]: 2.6 mm, number of solder pins per potential: 1, plug-in system: COMBICON MSTB 2,5, Pin connector pattern alignment: Standard, locking: without, mounting: without, type of packaging: packed in cardboard, For user information and design recommendations for through-hole reflow technology, go to: Downloads

# FKCVW 2,5/ 5-ST-5,08 - PCB connector



1873689

<https://www.phoenixcontact.com/de/produkte/1873689>

## CC 2,5/ 5-G-5,08 P26THRR56 - PCB header

1954618

<https://www.phoenixcontact.com/de/produkte/1954618>



PCB headers, nominal cross section: 2.5 mm<sup>2</sup>, color: black, nominal current: 12 A, rated voltage (III/2): 320 V, contact surface: Tin, contact connection type: Pin, number of potentials: 5, number of rows: 1, number of positions: 5, number of connections: 5, product range: CC 2,5/..-G, pitch: 5.08 mm, mounting: THR soldering, pin layout: Linear pinning, solder pin [P]: 2.6 mm, number of solder pins per potential: 1, plug-in system: COMBICON MSTB 2,5, Pin connector pattern alignment: Standard, locking: without, mounting: without, type of packaging: 56 mm wide tape, For user information and design recommendations for through-hole reflow technology, go to: Downloads

## CCA 2,5/ 5-G-5,08 P26THR - PCB header

1954948

<https://www.phoenixcontact.com/de/produkte/1954948>



PCB headers, nominal cross section: 2.5 mm<sup>2</sup>, color: black, nominal current: 12 A, rated voltage (III/2): 320 V, contact surface: Tin, contact connection type: Pin, number of potentials: 5, number of rows: 1, number of positions: 5, number of connections: 5, product range: CCA 2,5/..-G, pitch: 5.08 mm, connection method: Plug-in connection, mounting: THR soldering, pin layout: Linear pinning, solder pin [P]: 2.6 mm, number of solder pins per potential: 1, plug-in system: COMBICON MSTB 2,5, Pin connector pattern alignment: Standard, locking: without, mounting: without, type of packaging: packed in cardboard, For user information and design recommendations for through-hole reflow technology, go to: Downloads

# FKCVW 2,5/ 5-ST-5,08 - PCB connector

1873689

<https://www.phoenixcontact.com/de/produkte/1873689>

## CCA 2,5/ 5-G-5,08 P26THRR56 - PCB header

1955060

<https://www.phoenixcontact.com/de/produkte/1955060>



PCB headers, nominal cross section: 2.5 mm<sup>2</sup>, color: black, nominal current: 12 A, rated voltage (III/2): 320 V, contact surface: Tin, contact connection type: Pin, number of potentials: 5, number of rows: 1, number of positions: 5, number of connections: 5, product range: CCA 2,5/..-G, pitch: 5.08 mm, connection method: Plug-in connection, mounting: THR soldering, pin layout: Linear pinning, solder pin [P]: 2.6 mm, number of solder pins per potential: 1, plug-in system: COMBICON MSTB 2,5, Pin connector pattern alignment: Standard, locking: without, mounting: without, type of packaging: 56 mm wide tape, For user information and design recommendations for through-hole reflow technology, go to: Downloads

## CCV 2,5/ 5-G-5,08 P26THR - PCB header

1955413

<https://www.phoenixcontact.com/de/produkte/1955413>



PCB headers, nominal cross section: 2.5 mm<sup>2</sup>, color: black, nominal current: 12 A, rated voltage (III/2): 320 V, contact surface: Tin, contact connection type: Pin, number of potentials: 5, number of rows: 1, number of positions: 5, number of connections: 5, product range: CCV 2,5/..-G, pitch: 5.08 mm, mounting: THR soldering, pin layout: Linear pinning, solder pin [P]: 2.6 mm, number of solder pins per potential: 1, plug-in system: COMBICON MSTB 2,5, Pin connector pattern alignment: Standard, locking: without, mounting: without, type of packaging: packed in cardboard, For user information and design recommendations for through-hole reflow technology, go to: Downloads

# FKCVW 2,5/ 5-ST-5,08 - PCB connector

1873689

<https://www.phoenixcontact.com/de/produkte/1873689>



## CCVA 2,5/ 5-G-5,08 P26THRR56 - PCB header

1955992

<https://www.phoenixcontact.com/de/produkte/1955992>



PCB headers, nominal cross section: 2.5 mm<sup>2</sup>, color: black, nominal current: 12 A, rated voltage (III/2): 320 V, contact surface: Tin, contact connection type: Pin, number of potentials: 5, number of rows: 1, number of positions: 5, number of connections: 5, product range: CCVA 2,5/..-G, pitch: 5.08 mm, mounting: THR soldering, pin layout: Linear pinning, solder pin [P]: 2.6 mm, number of solder pins per potential: 1, plug-in system: COMBICON MSTB 2,5, Pin connector pattern alignment: Standard, locking: without, mounting: without, type of packaging: 56 mm wide tape, For user information and design recommendations for through-hole reflow technology, go to: Downloads

---

Phoenix Contact 2023 © - all rights reserved

<https://www.phoenixcontact.com>

PHOENIX CONTACT Deutschland GmbH

Flachsmarktstraße 8

D-32825 Blomberg

+49 52 35/3-1 20 00

[info@phoenixcontact.de](mailto:info@phoenixcontact.de)