

MDSTBV 2,5/ 4-GF - PCB header



1846108

<https://www.phoenixcontact.com/de/produkte/1846108>

Please be informed that the data shown in this PDF document is generated from our Online Catalog. Please find the complete data in the user documentation. Our General Terms of Use for Downloads are valid.

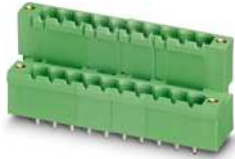

PCB headers, nominal cross section: 2.5 mm², color: green, nominal current: 10 A, rated voltage (III/2): 320 V, contact surface: Tin, type of contact: Male connector, number of potentials: 8, number of rows: 2, number of positions: 4, number of connections: 8, product range: MDSTBV 2,5/...-GF, pitch: 5 mm, mounting: Wave soldering, pin layout: Linear pinning, solder pin [P]: 3.9 mm, number of solder pins per potential: 1, plug-in system: COMBICON MSTB 2,5, Pin connector pattern alignment: Standard, locking: Screw locking, mounting: Threaded flange, type of packaging: packed in cardboard, The article can be aligned to create different nos. of positions! In combination with MVSTB or FKCV plug components, both an MVSTBW (or FKCVW) and an MVSTBR plug (or FKCVR) must be used. Combination with TMSTBP plug components is not possible!

Your advantages

- Maximum flexibility when it comes to device design – one header for connectors with different connection technologies
- Easy PCB replacement thanks to plug-in modules
- Well-known mounting principle allows worldwide use
- Conductor connection on several levels enables higher contact density
- Screwable flange for superior mechanical stability

Commercial Data

Item number	1846108
Packing unit	50 pc
Minimum order quantity	50 pc
Sales Key	E1 - Leiterplattenanschl.
Product Key	AACSCE
Catalog Page	Page 331 (C-1-2013)
GTIN	4017918183608
Weight per Piece (including packing)	10,568 g
Weight per Piece (excluding packing)	9,82 g
Customs tariff number	85366930
Country of origin	DE

MDSTBV 2,5/ 4-GF - PCB header



1846108

<https://www.phoenixcontact.com/de/produkte/1846108>

Technical Data

Product properties

Type	Header can be aligned
Product line	COMBICON Connectors M
Product type	PCB headers
Product family	MDSTBV 2,5/..-GF
Number of positions	4
Pitch	5 mm
Number of connections	8
Number of rows	2
Mounting flange	Threaded flange
Number of potentials	8
Pin layout	Linear pinning
Solder pins per potential	1

Electrical properties

Nominal current I_N	10 A
Nominal voltage U_N	320 V
Degree of pollution	3
Contact resistance	2.5 m Ω
Rated voltage (III/3)	250 V
Rated surge voltage (III/3)	4 kV
Rated voltage (III/2)	320 V
Rated surge voltage (III/2)	4 kV
Rated voltage (II/2)	400 V
Rated surge voltage (II/2)	4 kV

Mounting

Mounting type	Wave soldering
Pin layout	Linear pinning

Flange

Tightening torque	0.3 Nm
-------------------	--------

Material specifications

Material data - contact

Note	WEEE/RoHS-compliant, free of whiskers according to IEC 60068-2-82/JEDEC JESD 201
Contact material	Cu alloy
Surface characteristics	Tin-plated
Metal surface contact area (top layer)	Tin (5 - 7 μ m Sn)
Metal surface contact area (middle layer)	Nickel (2 - 3 μ m Ni)
Metal surface soldering area (top layer)	Tin (5 - 7 μ m Sn)

MDSTBV 2,5/ 4-GF - PCB header

1846108

<https://www.phoenixcontact.com/de/produkte/1846108>

Metal surface soldering area (middle layer)	Nickel (2 - 3 μm Ni)
---	---------------------------------

Material data - housing

Color (Housing)	green (6021)
Insulating material	PBT
Insulating material group	IIIa
CTI according to IEC 60112	225
Flammability rating according to UL 94	V0

Material data – actuating element

Color ()	()
----------	----

Notes

Notes on operation	In accordance with IEC 61984, COMBICON connectors have no switching power (COC). During designated use, they must not be plugged in or disconnected when carrying voltage or under load.
--------------------	--

Dimensions

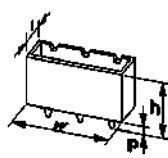
Dimensional drawing	
Pitch	5 mm
Width [w]	32.5 mm
Height [h]	25.9 mm
Length [l]	23.7 mm
Installed height	22 mm
Solder pin length [P]	3.9 mm

Mechanical tests

Test for conductor damage and slackening

Specification	IEC 60999-1:1999-11
Result	Test passed

Pull-out test

Specification	IEC 60999-1:1999-11
Conductor cross section/conductor type/tractive force setpoint/actual value	0.2 mm ² / solid / > 10 N
	0.2 mm ² / flexible / > 10 N
	2.5 mm ² / solid / > 50 N
	2.5 mm ² / flexible / > 50 N

Insertion and withdrawal forces

Result	Test passed
No. of cycles	25

MDSTBV 2,5/ 4-GF - PCB header



1846108

<https://www.phoenixcontact.com/de/produkte/1846108>

Insertion strength per pos. approx.	8 N
Withdraw strength per pos. approx.	6 N

Torque test

Specification	IEC 60999-1:1999-11
---------------	---------------------

Contact holder in insert

Specification	IEC 60512-15-1:2008-05
Contact holder in insert Requirements >20 N	Test passed

Resistance of inscriptions

Specification	IEC 60068-2-70:1995-12
Result	Test passed

Polarization and coding

Specification	IEC 60512-13-5:2006-02
Result	Test passed

Visual inspection

Specification	IEC 60512-1-1:2002-02
Result	Test passed

Dimension check

Specification	IEC 60512-1-2:2002-02
Result	Test passed

Electrical tests

Thermal test | Test group C

Specification	IEC 60512-5-1:2002-02
Tested number of positions	12

Insulation resistance

Specification	IEC 60512-3-1:2002-02
Insulation resistance, neighboring positions	> 5 MΩ

Air clearances and creepage distances |

Specification	IEC 60664-1:2007-04
Insulating material group	IIIa
Comparative tracking index (IEC 60112)	CTI 225
Rated insulation voltage (III/3)	250 V
Rated surge voltage (III/3)	4 kV
minimum clearance value - non-homogenous field (III/3)	3 mm
minimum creepage distance (III/3)	4 mm
Rated insulation voltage (III/2)	320 V
Rated surge voltage (III/2)	4 kV
minimum clearance value - non-homogenous field (III/2)	3 mm

MDSTBV 2,5/ 4-GF - PCB header



1846108

<https://www.phoenixcontact.com/de/produkte/1846108>

minimum creepage distance (III/2)	4 mm
Rated insulation voltage (II/2)	400 V
Rated surge voltage (II/2)	4 kV
minimum clearance value - non-homogenous field (II/2)	3 mm
minimum creepage distance (II/2)	4 mm

Environmental and real-life conditions

Vibration test

Specification	IEC 60068-2-6:2007-12
Frequency	10 - 150 - 10 Hz
Sweep speed	1 octave/min
Amplitude	0.35 mm (10 Hz ... 60.1 Hz)
Sweep speed	5g (60.1 Hz ... 150 Hz)
Test duration per axis	2.5 h

Durability test

Specification	IEC 60512-9-1:2010-03
Impulse withstand voltage at sea level	4.8 kV
Contact resistance R ₁	2.5 mΩ
Contact resistance R ₂	2.6 mΩ
Contact resistance R ₂ 2nd level	1.5 mΩ
Insertion/withdrawal cycles	25
Insulation resistance, neighboring positions	> 5 MΩ

Climatic test

Specification	ISO 6988:1985-02
Corrosive stress	0.2 dm ³ SO ₂ on 300 dm ³ /40 °C/1 cycle
Thermal stress	100 °C/168 h
Power-frequency withstand voltage	2.21 kV

Ambient conditions

Ambient temperature (operation)	-40 °C ... 100 °C (dependent on the derating curve)
Ambient temperature (storage/transport)	-40 °C ... 70 °C
Relative humidity (storage/transport)	30 % ... 70 %
Ambient temperature (assembly)	-5 °C ... 100 °C

Packaging specifications

Type of packaging	packed in cardboard
-------------------	---------------------

Drawings

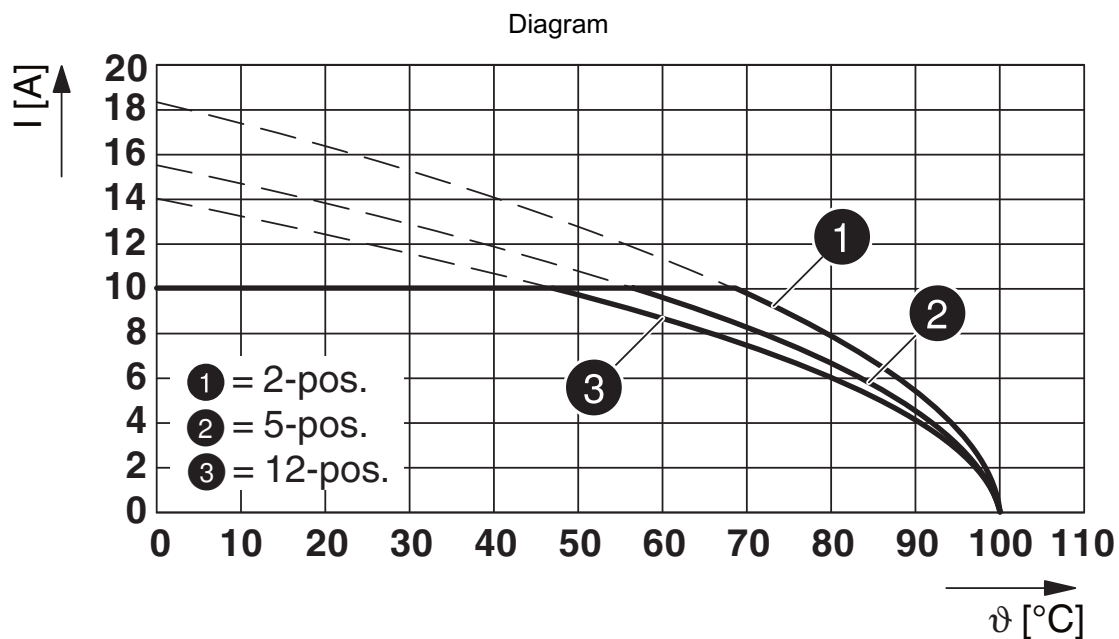

Type: MSTBT 2,5/...-STF with MDSTBV 2,5/...-GF

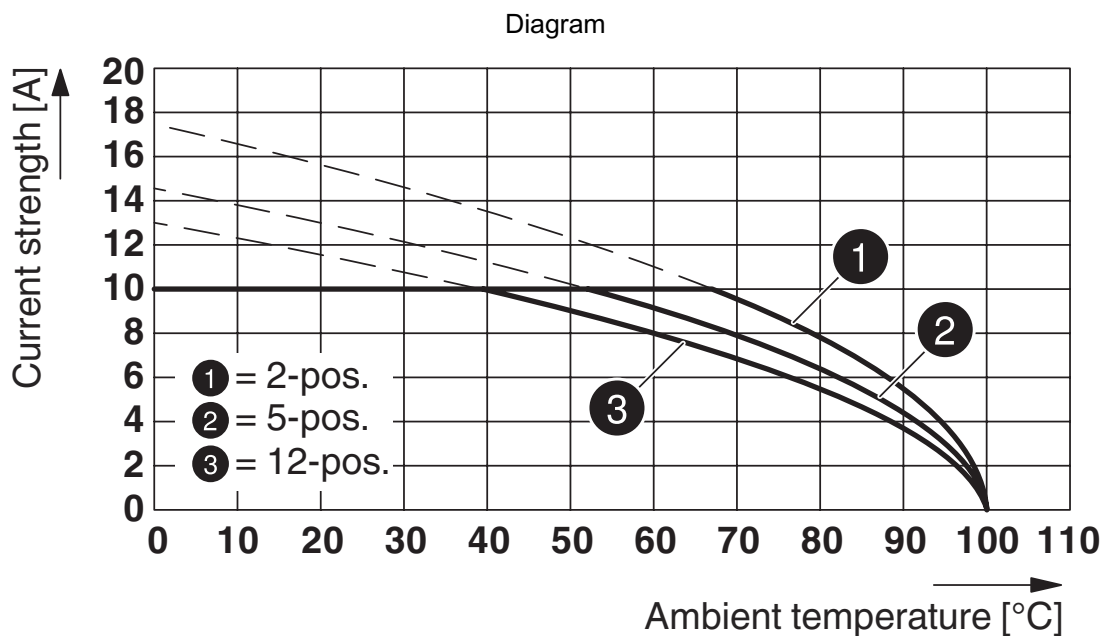

Type: FRONT-MSTB 2,5/...-STF-5,08 with MDSTBV 2,5/...-GF

1846108

<https://www.phoenixcontact.com/de/produkte/1846108>

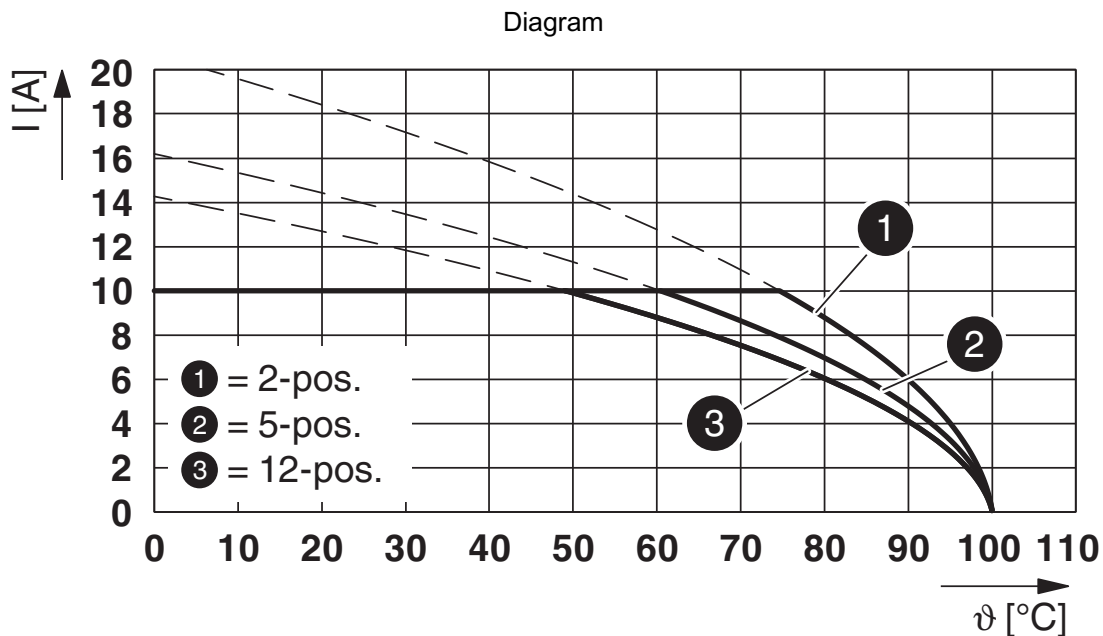

Type: FKCT 2,5/...-STF with MDSTBV 2,5/...-GF

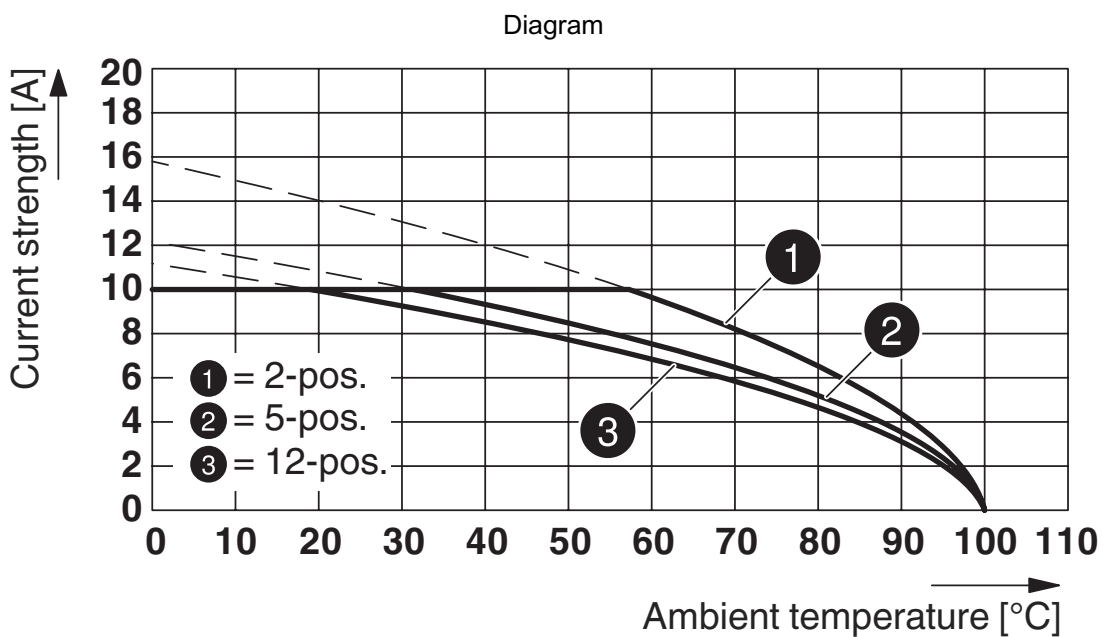

Type: MVSTB(R/W) 2,5/...-STF with MDSTBV 2,5/...-GF

1846108

<https://www.phoenixcontact.com/de/produkte/1846108>

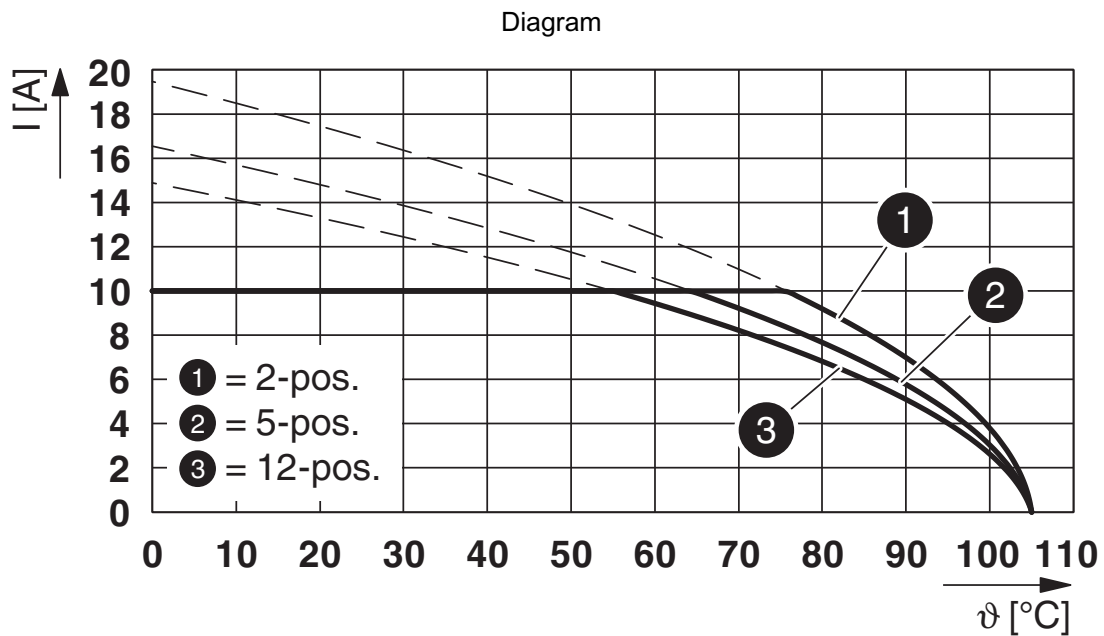

Type: FKCVR 2,5/...-STF with MDSTBV 2,5/...-GF

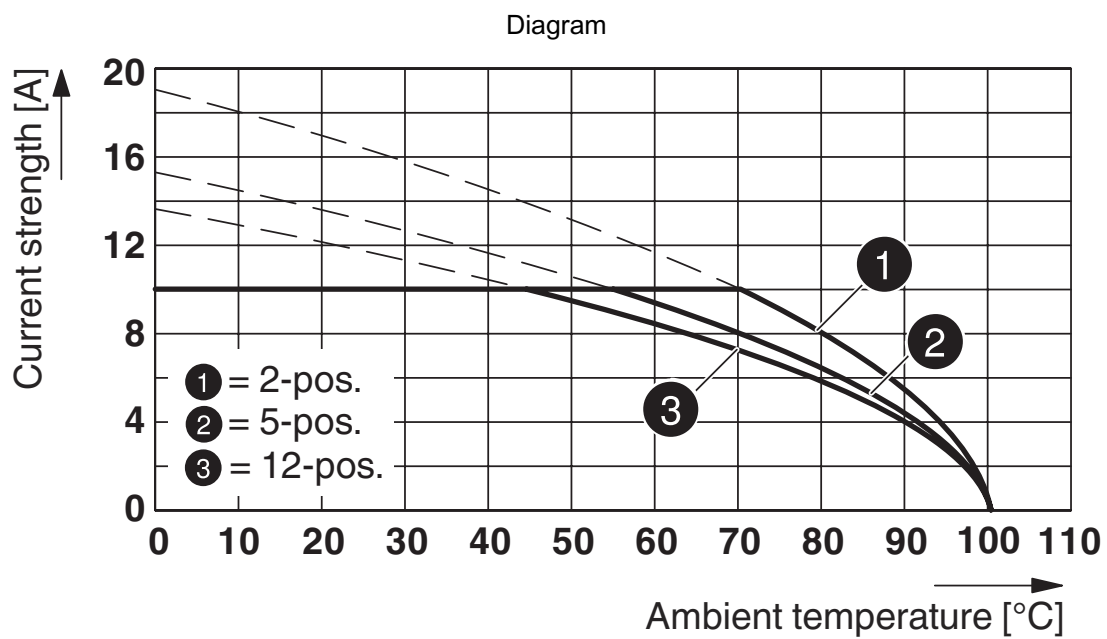

Type: MSTB 2,5/...-STF with MDSTBV 2,5/...-GF

MDSTBV 2,5/ 4-GF - PCB header



1846108

<https://www.phoenixcontact.com/de/produkte/1846108>

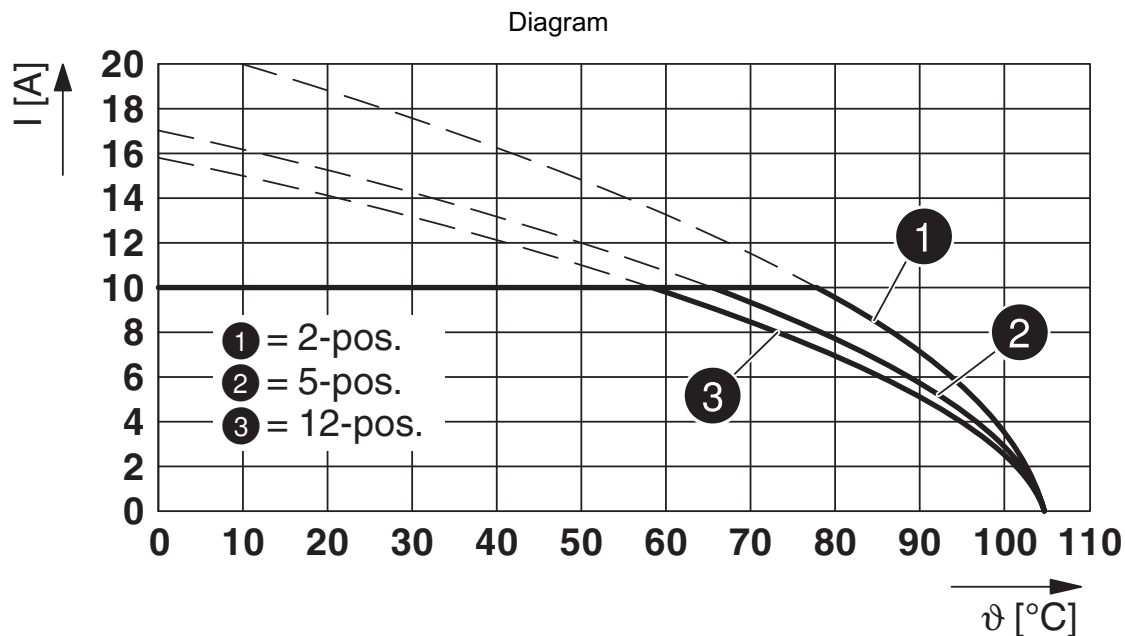

Type: FKCN 2,5/...-STF with MDSTBV 2,5/...-GF

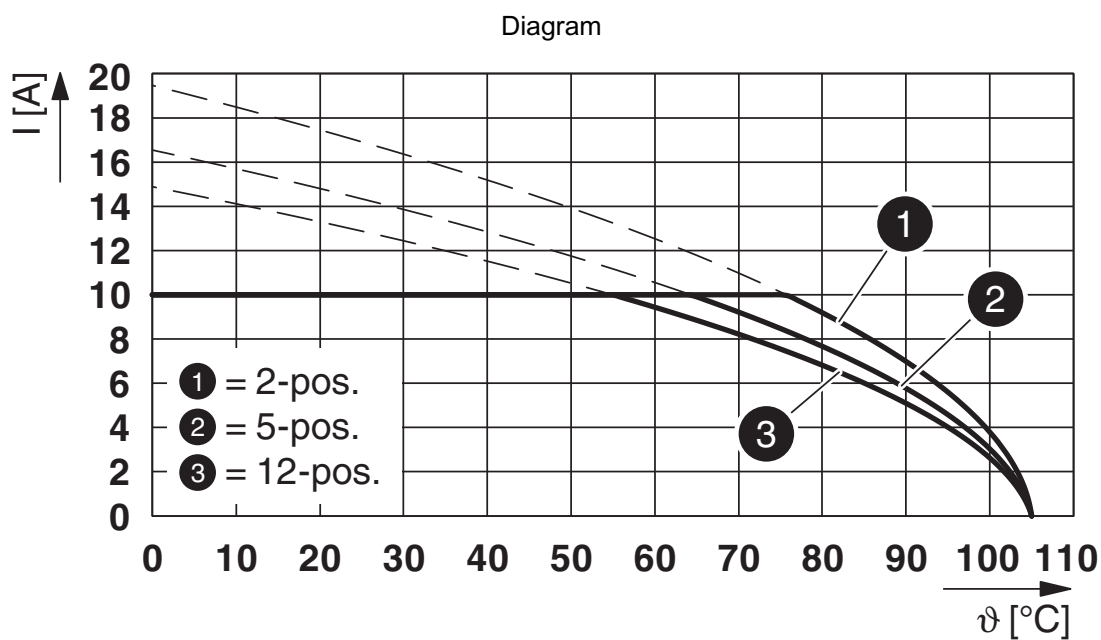

Type: FKCVW 2,5/...-STF with MDSTBV 2,5/...-GF

MDSTBV 2,5/ 4-GF - PCB header





1846108

<https://www.phoenixcontact.com/de/produkte/1846108>

Approvals

 IECEE CB Scheme Approval ID: DE1-60988-B1B2				
	Nominal Voltage U_N	Nominal Current I_N	Cross Section AWG	Cross Section mm^2
	250 V	10 A	-	-

 EAC Approval ID: B.01687				
--	--	--	--	--

 cULus Recognized Approval ID: E60425-19931011				
	Nominal Voltage U_N	Nominal Current I_N	Cross Section AWG	Cross Section mm^2
Use group B				
	300 V	12 A	-	-
Use group D				
	150 V	12 A	-	-

 VDE Zeichengenehmigung Approval ID: 40050648				
	Nominal Voltage U_N	Nominal Current I_N	Cross Section AWG	Cross Section mm^2
	250 V	10 A	-	-

MDSTBV 2,5/ 4-GF - PCB header



1846108

<https://www.phoenixcontact.com/de/produkte/1846108>

Classifications

ECLASS

ECLASS-9.0	27440402
ECLASS-10.0.1	27440402
ECLASS-11.0	27460201

ETIM

ETIM 8.0	EC002637
----------	----------

UNSPSC

UNSPSC 21.0	39121400
-------------	----------

MDSTBV 2,5/ 4-GF - PCB header

1846108

<https://www.phoenixcontact.com/de/produkte/1846108>



Environmental Product Compliance

REACH SVHC	Lead 7439-92-1
China RoHS	Environmentally Friendly Use Period = 50 years
	For information on hazardous substances, refer to the manufacturer's declaration available under "Downloads"

MDSTBV 2,5/ 4-GF - PCB header

1846108

<https://www.phoenixcontact.com/de/produkte/1846108>



Accessories

MSTB-BL - Accessories

1755477

<https://www.phoenixcontact.com/de/produkte/1755477>



Keying cap, for forming sections, plugs onto header pin, green insulating material

CR-MSTB - Coding section

1734401

<https://www.phoenixcontact.com/de/produkte/1734401>



Coding section, inserted into the recess in the header or the inverted plug, red insulating material

MDSTBV 2,5/ 4-GF - PCB header

1846108

<https://www.phoenixcontact.com/de/produkte/1846108>



SK 5/3,8:FORTL.ZAHLEN - Marker card

0804183

<https://www.phoenixcontact.com/de/produkte/0804183>



Marker card, white, labeled, horizontal: consecutive numbers 1 ... 10, 11 ... 20, etc. up to 91 ... (99)100, mounting type: adhesive, for terminal block width: 5 mm, lettering field size: 5 x 3.8 mm

SK 5/3,8:UNBEDRUCKT - Marker card

0805409

<https://www.phoenixcontact.com/de/produkte/0805409>



Marker card, white, unlabeled, can be labeled with: Marker pen, mounting type: adhesive, for terminal block width: 5 mm, lettering field size: 5 x 3.8 mm

MDSTBV 2,5/ 4-GF - PCB header

1846108

<https://www.phoenixcontact.com/de/produkte/1846108>



FKCN 2,5/ 4-STF - PCB connector

1732988

<https://www.phoenixcontact.com/de/produkte/1732988>



PCB connector, nominal cross section: 2.5 mm², color: green, nominal current: 12 A, rated voltage (III/2): 320 V, contact surface: Tin, type of contact: Female connector, number of potentials: 4, number of rows: 1, number of positions: 4, number of connections: 4, product range: FKCN 2,5/..-STF, pitch: 5 mm, connection method: Push-in spring connection, conductor/PCB connection direction: 0 °, locking clip: - Locking clip, plug-in system: COMBICON MSTB 2,5, locking: Screw locking, mounting: Screw flange, type of packaging: packed in cardboard

FRONT-MSTB 2,5/ 4-STF - PCB connector

1779660

<https://www.phoenixcontact.com/de/produkte/1779660>



PCB connector, nominal cross section: 2.5 mm², color: green, nominal current: 12 A, rated voltage (III/2): 320 V, contact surface: Tin, type of contact: Female connector, number of potentials: 4, number of rows: 1, number of positions: 4, number of connections: 4, product range: FRONT-MSTB 2,5/..-STF, pitch: 5 mm, connection method: Front screw connection, screw head form: L Slotted, conductor/PCB connection direction: 0 °, locking clip: - Locking clip, plug-in system: COMBICON MSTB 2,5, locking: Screw locking, mounting: Screw flange, type of packaging: packed in cardboard

MDSTBV 2,5/ 4-GF - PCB header

1846108

<https://www.phoenixcontact.com/de/produkte/1846108>



MVSTBR 2,5/ 4-STF - PCB connector

1835494

<https://www.phoenixcontact.com/de/produkte/1835494>



PCB connector, nominal cross section: 2.5 mm², color: green, nominal current: 12 A, rated voltage (III/2): 320 V, contact surface: Tin, type of contact: Female connector, number of potentials: 4, number of rows: 1, number of positions: 4, number of connections: 4, product range: MVSTBR 2,5/..-STF, pitch: 5 mm, connection method: Screw connection with tension sleeve, screw head form: L Slotted, conductor/PCB connection direction: 90 °, locking clip: - Locking clip, plug-in system: COMBICON MSTB 2,5, locking: Screw locking, mounting: Screw flange, type of packaging: packed in cardboard

FKCT 2,5/ 4-STF - PCB connector

1909427

<https://www.phoenixcontact.com/de/produkte/1909427>



PCB connector, nominal cross section: 2.5 mm², color: green, nominal current: 12 A, rated voltage (III/2): 320 V, contact surface: Tin, type of contact: Female connector, number of potentials: 4, number of rows: 1, number of positions: 4, number of connections: 4, product range: FKCT 2,5/..-STF, pitch: 5 mm, connection method: Push-in spring connection, conductor/PCB connection direction: 0 °, locking clip: - without locking clip, plug-in system: COMBICON MSTB 2,5, locking: Screw locking, mounting: Screw flange, type of packaging: packed in cardboard

MDSTBV 2,5/ 4-GF - PCB header

1846108

<https://www.phoenixcontact.com/de/produkte/1846108>



FKCVR 2,5/ 4-STF - PCB connector

1909906

<https://www.phoenixcontact.com/de/produkte/1909906>



PCB connector, nominal cross section: 2.5 mm², color: green, nominal current: 12 A, rated voltage (III/2): 320 V, contact surface: Tin, type of contact: Female connector, number of potentials: 4, number of rows: 1, number of positions: 4, number of connections: 4, product range: FKCVR 2,5/...-STF, pitch: 5 mm, connection method: Push-in spring connection, conductor/PCB connection direction: 90 °, locking clip: - Locking clip, plug-in system: COMBICON MSTB 2,5, locking: Screw locking, mounting: Screw flange, type of packaging: packed in cardboard

FKCVW 2,5/ 4-STF - PCB connector

1910225

<https://www.phoenixcontact.com/de/produkte/1910225>

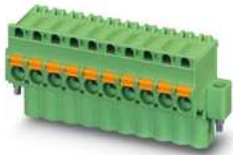

PCB connector, nominal cross section: 2.5 mm², color: green, nominal current: 12 A, rated voltage (III/2): 320 V, contact surface: Tin, type of contact: Female connector, number of potentials: 4, number of rows: 1, number of positions: 4, number of connections: 4, product range: FKCVW 2,5/...-STF, pitch: 5 mm, connection method: Push-in spring connection, conductor/PCB connection direction: -90 °, locking clip: - Locking clip, plug-in system: COMBICON MSTB 2,5, locking: Screw locking, mounting: Screw flange, type of packaging: packed in cardboard

MDSTBV 2,5/ 4-GF - PCB header

1846108

<https://www.phoenixcontact.com/de/produkte/1846108>



FKC 2,5/ 4-STF - PCB connector

1910542

<https://www.phoenixcontact.com/de/produkte/1910542>



PCB connector, nominal cross section: 2.5 mm², color: green, nominal current: 12 A, rated voltage (III/2): 320 V, contact surface: Tin, type of contact: Female connector, number of potentials: 4, number of rows: 1, number of positions: 4, number of connections: 4, product range: FKC 2,5/...-STF, pitch: 5 mm, connection method: Push-in spring connection, conductor/PCB connection direction: 0 °, locking clip: - Locking clip, plug-in system: COMBICON MSTB 2,5, locking: Screw locking, mounting: Screw flange, type of packaging: packed in cardboard

SMSTB 2,5/ 4-STF - PCB connector

1970896

<https://www.phoenixcontact.com/de/produkte/1970896>



PCB connector, nominal cross section: 2.5 mm², color: green, nominal current: 12 A, rated voltage (III/2): 320 V, contact surface: Tin, type of contact: Female connector, number of potentials: 4, number of rows: 1, number of positions: 4, number of connections: 4, product range: SMSTB 2,5/...-STF, pitch: 5 mm, connection method: Screw connection with tension sleeve, screw head form: L Slotted, conductor/PCB connection direction: -45 °, locking clip: - Locking clip, plug-in system: COMBICON MSTB 2,5, locking: Screw locking, mounting: Screw flange, type of packaging: packed in cardboard

Phoenix Contact 2023 © - all rights reserved
<https://www.phoenixcontact.com>

PHOENIX CONTACT Deutschland GmbH
Flachsmarktstraße 8
D-32825 Blomberg
+49 52 35/3-1 20 00
info@phoenixcontact.de