

MDSTBVA 2,5/10-G - PCB header



1845866

<https://www.phoenixcontact.com/de/produkte/1845866>

Please be informed that the data shown in this PDF document is generated from our online catalog. Please find the complete data in the user documentation. Our general terms of use for downloads are valid.



PCB headers, nominal cross section: 2.5 mm², color: green, nominal current: 10 A, rated voltage (III/2): 320 V, contact surface: Tin, contact connection type: Pin, number of potentials: 20, number of rows: 2, number of positions: 10, number of connections: 20, product range: MDSTBVA 2,5/..-G, pitch: 5 mm, mounting: Wave soldering, pin layout: Linear pinning, solder pin [P]: 3.9 mm, number of solder pins per potential: 1, plug-in system: COMBICON MSTB 2,5, Pin connector pattern alignment: Standard, locking: without, mounting: without, type of packaging: packed in cardboard, The article can be aligned to create different nos. of positions! In combination with MVSTB or FKCV plug components, both an MVSTBW (or FKCVW) and an MVSTBR plug (or FKCVR) must be used. Combination with TMSTBP plug components is not possible!

Your advantages

- Maximum flexibility when it comes to device design – one header for connectors with different connection technologies
- Easy PCB replacement thanks to plug-in modules
- Well-known mounting principle allows worldwide use
- Conductor connection on several levels enables higher contact density

Commercial data

Item number	1845866
Packing unit	50 pc
Minimum order quantity	50 pc
Sales key	E1 - Leiterplattenanschl.
Product key	AACSCF
Catalog page	Page 331 (C-1-2013)
GTIN	4017918183387
Weight per piece (including packing)	15,49 g
Weight per piece (excluding packing)	14,526 g
Customs tariff number	85366930
Country of origin	DE

Technical data

Product properties

Type	Header can be aligned
Product line	COMBICON Connectors M
Product type	PCB headers
Product family	MDSTBVA 2,5/..-G
Number of positions	10
Pitch	5 mm
Number of connections	20
Number of rows	2
Mounting flange	without
Number of potentials	20
Pin layout	Linear pinning
Solder pins per potential	1

Electrical properties

Nominal current I_N	10 A
Nominal voltage U_N	320 V
Degree of pollution	3
Contact resistance	2.5 mΩ
Rated voltage (III/3)	250 V
Rated surge voltage (III/3)	4 kV
Rated voltage (III/2)	320 V
Rated surge voltage (III/2)	4 kV
Rated voltage (II/2)	400 V
Rated surge voltage (II/2)	4 kV

Mounting

Mounting type	Wave soldering
Pin layout	Linear pinning

Material specifications

Material data - contact

Note	WEEE/RoHS-compliant, free of whiskers according to IEC 60068-2-82/JEDEC JESD 201
Contact material	Cu alloy
Surface characteristics	Tin-plated
Metal surface contact area (top layer)	Tin (5 - 7 μm Sn)
Metal surface contact area (middle layer)	Nickel (2 - 3 μm Ni)
Metal surface soldering area (top layer)	Tin (5 - 7 μm Sn)
Metal surface soldering area (middle layer)	Nickel (2 - 3 μm Ni)

Material data - housing

MDSTBVA 2,5/10-G - PCB header

1845866

<https://www.phoenixcontact.com/de/produkte/1845866>

Color (Housing)	green (6021)
Insulating material	PBT
Insulating material group	IIIa
CTI according to IEC 60112	225
Flammability rating according to UL 94	V0

Notes

Notes on operation	In accordance with IEC 61984, COMBICON connectors have no switching power (COC). During designated use, they must not be plugged in or disconnected when carrying voltage or under load.
--------------------	--

Dimensions

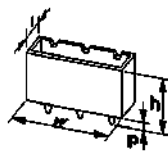
Dimensional drawing	
Pitch	5 mm
Width [w]	54.5 mm
Height [h]	25.9 mm
Length [l]	23.7 mm
Installed height	22 mm
Solder pin length [P]	3.9 mm
Pin dimensions	1 x 1 mm

Mechanical tests

Visual inspection

Specification	IEC 60512-1-1:2002-02
Result	Test passed

Dimension check

Specification	IEC 60512-1-2:2002-02
Result	Test passed

Resistance of inscriptions

Specification	IEC 60068-2-70:1995-12
Result	Test passed

Polarization and coding

Specification	IEC 60512-13-5:2006-02
Result	Test passed

Contact holder in insert

Specification	IEC 60512-15-1:2008-05
Contact holder in insert Requirements >20 N	Test passed

1845866

<https://www.phoenixcontact.com/de/produkte/1845866>

Insertion and withdrawal forces

Result	Test passed
No. of cycles	25
Insertion strength per pos. approx.	8 N
Withdraw strength per pos. approx.	6 N

Electrical tests

Thermal test | Test group C

Specification	IEC 60512-5-1:2002-02
Tested number of positions	12

Insulation resistance

Specification	IEC 60512-3-1:2002-02
Insulation resistance, neighboring positions	> 5 MΩ

Air clearances and creepage distances |

Specification	IEC 60664-1:2007-04
Insulating material group	IIIa
Comparative tracking index (IEC 60112)	CTI 225
Rated insulation voltage (III/3)	250 V
Rated surge voltage (III/3)	4 kV
minimum clearance value - non-homogenous field (III/3)	3 mm
minimum creepage distance (III/3)	4 mm
Rated insulation voltage (III/2)	320 V
Rated surge voltage (III/2)	4 kV
minimum clearance value - non-homogenous field (III/2)	3 mm
minimum creepage distance (III/2)	4 mm
Rated insulation voltage (II/2)	400 V
Rated surge voltage (II/2)	4 kV
minimum clearance value - non-homogenous field (II/2)	3 mm
minimum creepage distance (II/2)	4 mm

Environmental and real-life conditions

Vibration test

Specification	IEC 60068-2-6:2007-12
Frequency	10 - 150 - 10 Hz
Sweep speed	1 octave/min
Amplitude	0.35 mm (10 Hz ... 60.1 Hz)
Sweep speed	5g (60.1 Hz ... 150 Hz)
Test duration per axis	2.5 h

Durability test

Specification	IEC 60512-9-1:2010-03
Impulse withstand voltage at sea level	4.8 kV

MDSTBVA 2,5/10-G - PCB header



1845866

<https://www.phoenixcontact.com/de/produkte/1845866>

Contact resistance R_1	2.5 m Ω
Contact resistance R_2	2.6 m Ω
Contact resistance R_2 2nd level	1.5 m Ω
Insertion/withdrawal cycles	25
Insulation resistance, neighboring positions	> 5 M Ω

Climatic test

Specification	ISO 6988:1985-02
Corrosive stress	0.2 dm ³ SO ₂ on 300 dm ³ /40 °C/1 cycle
Thermal stress	100 °C/168 h
Power-frequency withstand voltage	2.21 kV

Ambient conditions

Ambient temperature (operation)	-40 °C ... 100 °C (dependent on the derating curve)
Ambient temperature (storage/transport)	-40 °C ... 70 °C
Relative humidity (storage/transport)	30 % ... 70 %
Ambient temperature (assembly)	-5 °C ... 100 °C

Packaging specifications

Type of packaging	packed in cardboard
-------------------	---------------------

Drawings

Diagram

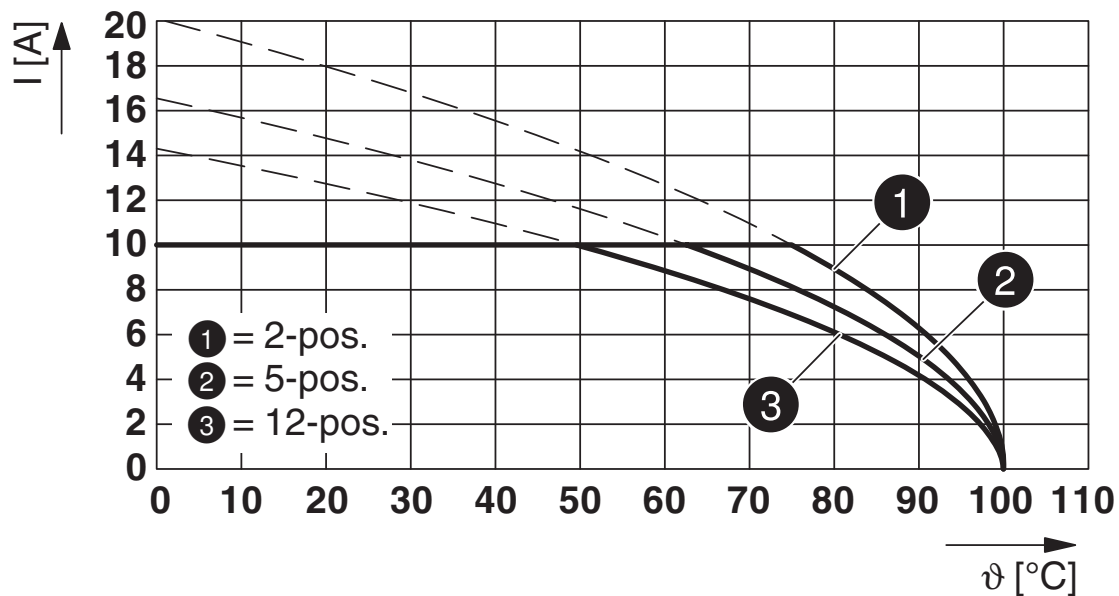

Type: FKCS 2,5/...-ST with MDSTBVA 2,5/...-G

Diagram

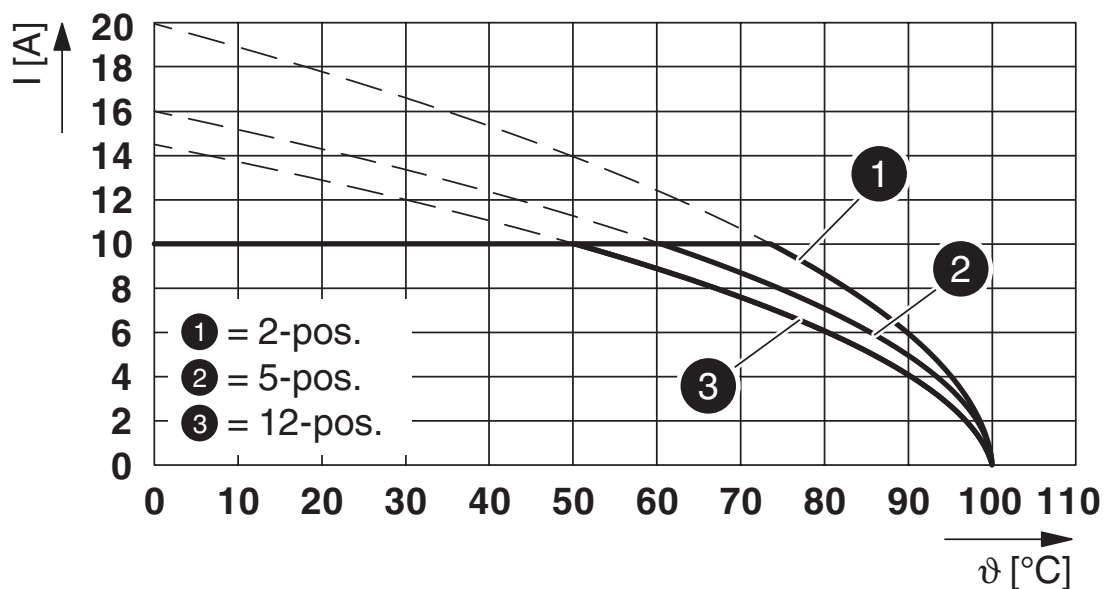

Type: FKCN 2,5/...-ST with MDSTBVA 2,5/...-G

1845866

<https://www.phoenixcontact.com/de/produkte/1845866>

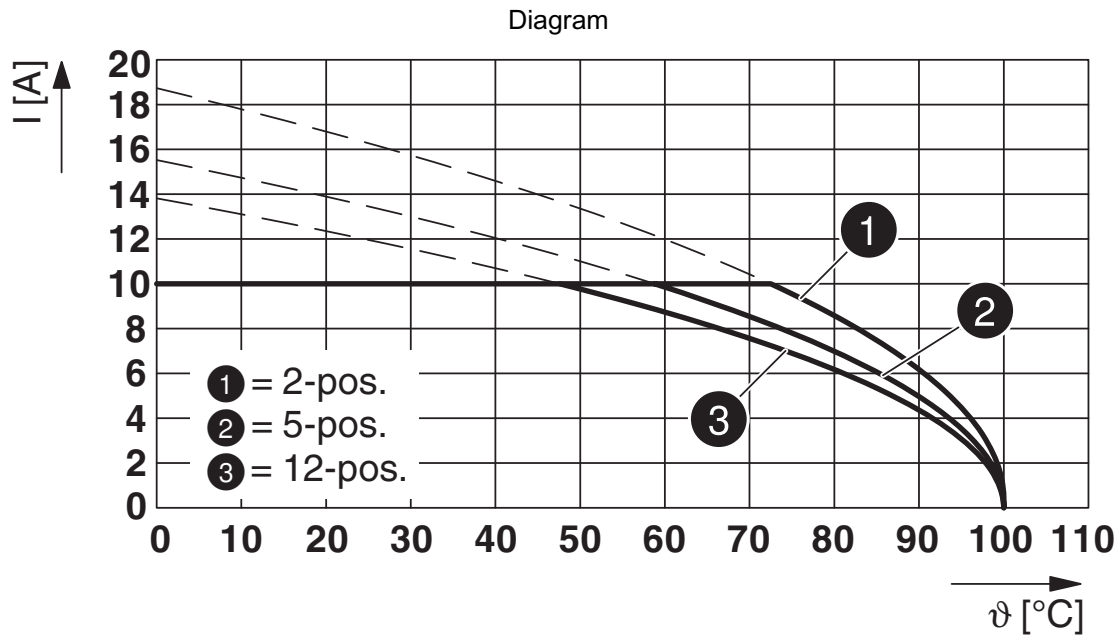

Type: FKCT 2,5/...-ST with MDSTBVA 2,5/...-G

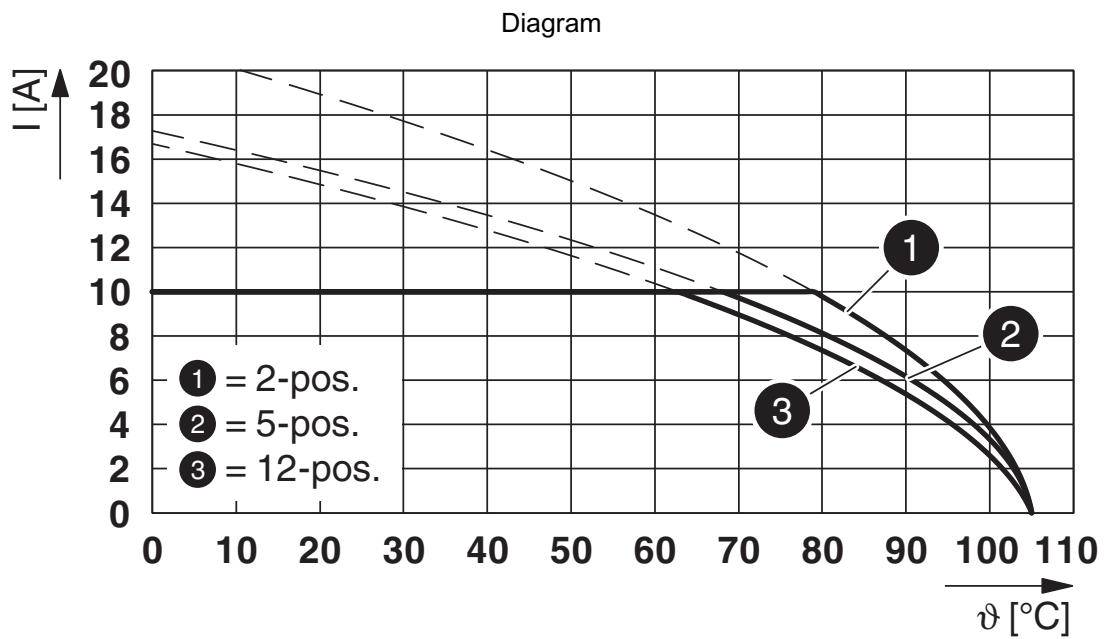

Type: FKCVR 2,5/...-ST with MDSTBVA 2,5/...-G

1845866

<https://www.phoenixcontact.com/de/produkte/1845866>

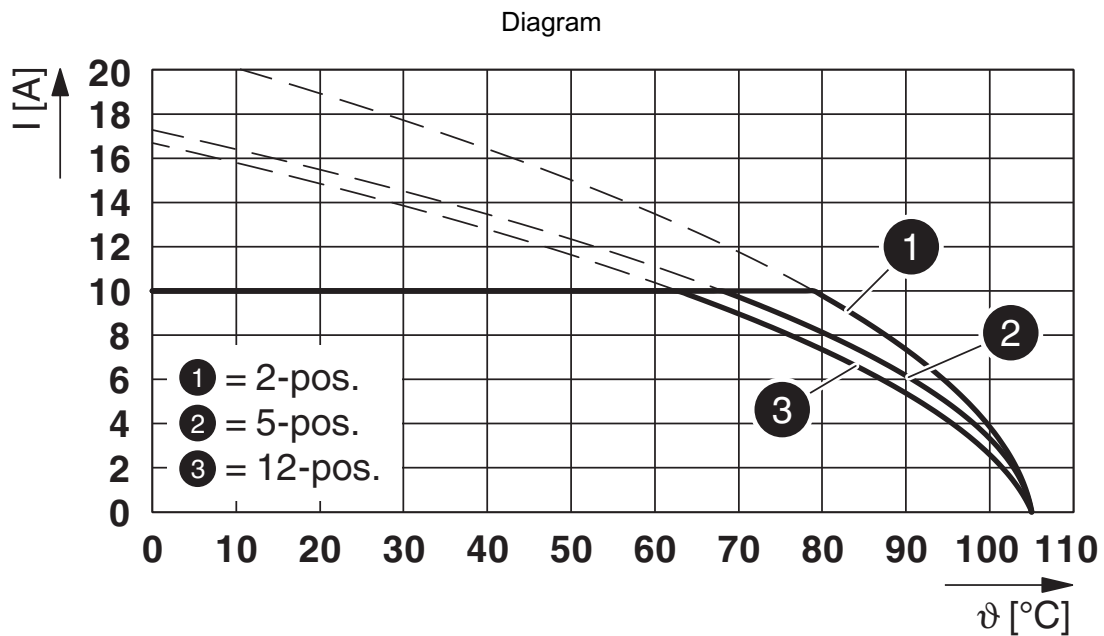

Type: FKCVW 2,5/...-ST with MDSTBVA 2,5/...-G

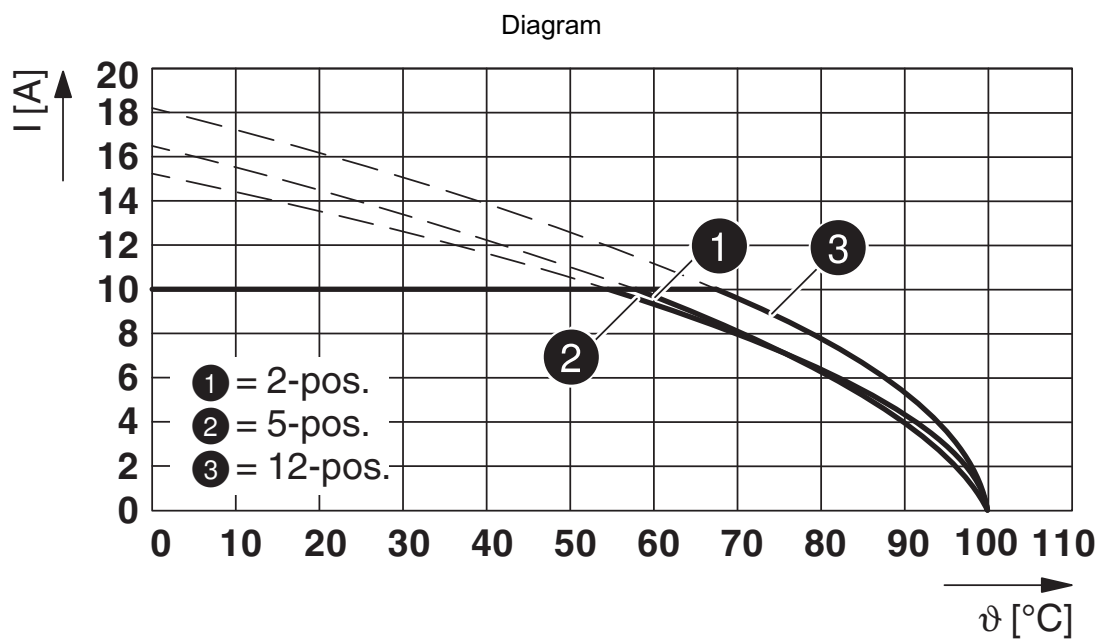

Type: MSTBP 2,5/...-ST with MDSTBVA 2,5/...-G

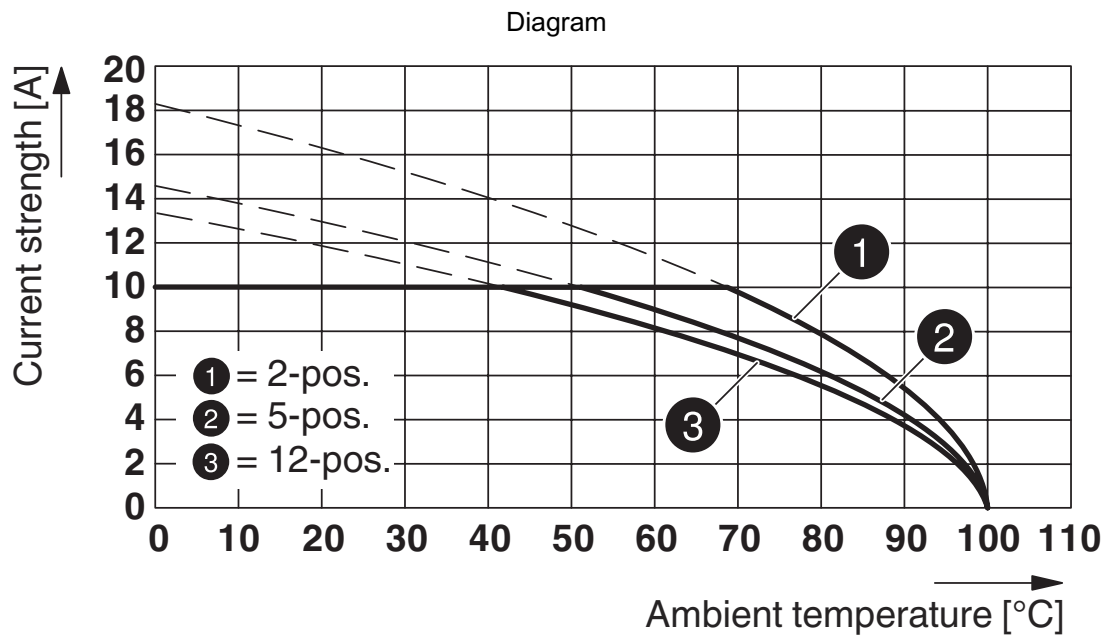

Type: FRONT-MSTB 2,5/...-ST with MDSTBVA 2,5/...-G

MDSTBVA 2,5/10-G - PCB header



1845866

<https://www.phoenixcontact.com/de/produkte/1845866>

Approvals

To download certificates, visit the product detail page: <https://www.phoenixcontact.com/de/produkte/1845866>



EAC

Approval ID: B.01687



cULus Recognized

Approval ID: E60425-19931011

	Nominal voltage U_N	Nominal current I_N	Cross section AWG	Cross section mm^2
Use group B				
	300 V	12 A	-	-
Use group D				
	300 V	10 A	-	-



VDE Zeichengenehmigung

Approval ID: 40050648

	Nominal voltage U_N	Nominal current I_N	Cross section AWG	Cross section mm^2
	250 V	10 A	-	-

MDSTBVA 2,5/10-G - PCB header



1845866

<https://www.phoenixcontact.com/de/produkte/1845866>

Classifications

ECLASS

ECLASS-11.0	27460201
ECLASS-12.0	27460201
ECLASS-13.0	27460201

ETIM

ETIM 8.0	EC002637
----------	----------

UNSPSC

UNSPSC 21.0	39121400
-------------	----------

MDSTBVA 2,5/10-G - PCB header

1845866

<https://www.phoenixcontact.com/de/produkte/1845866>



Environmental product compliance

China RoHS	Environmentally friendly use period: unlimited = EFUP-e
	No hazardous substances above threshold values

MDSTBVA 2,5/10-G - PCB header

1845866

<https://www.phoenixcontact.com/de/produkte/1845866>

Accessories

MSTB-BL - Accessories

1755477

<https://www.phoenixcontact.com/de/produkte/1755477>



Keying cap, for forming sections, plugs onto header pin, green insulating material

CR-MSTB - Coding section

1734401

<https://www.phoenixcontact.com/de/produkte/1734401>



Coding section, inserted into the recess in the header or the inverted plug, red insulating material

MDSTBVA 2,5/10-G - PCB header

1845866

<https://www.phoenixcontact.com/de/produkte/1845866>



SK 5/3,8:FORTL.ZAHLEN - Marker card

0804183

<https://www.phoenixcontact.com/de/produkte/0804183>



Marker card, white, labeled, horizontal: consecutive numbers 1 ... 10, 11 ... 20, etc. up to 91 ... (99)100, mounting type: adhesive, for terminal block width: 5 mm, lettering field size: 5 x 3.8 mm

TVFKC 1,5/10-ST - PCB connector

1713910

<https://www.phoenixcontact.com/de/produkte/1713910>



PCB connector, nominal cross section: 1.5 mm², color: green, nominal current: 10 A, rated voltage (III/2): 320 V, contact surface: Tin, contact connection type: Socket, number of potentials: 10, number of rows: 1, number of positions: 10, number of connections: 20, product range: TVFKC 1,5/..-ST, pitch: 5 mm, connection method: Push-in spring connection, conductor/PCB connection direction: 0 °, locking clip: - Locking clip, plug-in system: COMBICON MSTB 2,5, locking: without, mounting: without, type of packaging: packed in cardboard

MDSTBVA 2,5/10-G - PCB header

1845866

<https://www.phoenixcontact.com/de/produkte/1845866>



TVFKCL 1,5/10-ST - PCB connector

1716001

<https://www.phoenixcontact.com/de/produkte/1716001>

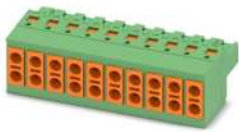

PCB connector, nominal cross section: 1.5 mm², color: green, nominal current: 10 A, rated voltage (III/2): 320 V, contact surface: Tin, contact connection type: Socket, number of potentials: 10, number of rows: 1, number of positions: 10, number of connections: 20, product range: TVFKCL 1,5/...-ST, pitch: 5 mm, connection method: Push-in spring connection, conductor/PCB connection direction: 0 °, locking clip: - Locking clip, plug-in system: COMBICON MSTB 2,5, locking: without, mounting: without, type of packaging: packed in cardboard

FKCN 2,5/10-ST - PCB connector

1732823

<https://www.phoenixcontact.com/de/produkte/1732823>

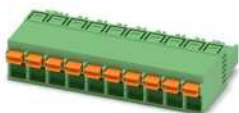

PCB connector, nominal cross section: 2.5 mm², color: green, nominal current: 12 A, rated voltage (III/2): 320 V, contact surface: Tin, contact connection type: Socket, number of potentials: 10, number of rows: 1, number of positions: 10, number of connections: 10, product range: FKCN 2,5/...-ST, pitch: 5 mm, connection method: Push-in spring connection, conductor/PCB connection direction: 0 °, locking clip: - Locking clip, plug-in system: COMBICON MSTB 2,5, locking: without, mounting: without, type of packaging: packed in cardboard

MDSTBVA 2,5/10-G - PCB header

1845866

<https://www.phoenixcontact.com/de/produkte/1845866>



MSTB 2,5/10-ST - PCB connector

1754601

<https://www.phoenixcontact.com/de/produkte/1754601>



PCB connector, nominal cross section: 2.5 mm², color: green, nominal current: 12 A, rated voltage (III/2): 320 V, contact surface: Tin, contact connection type: Socket, number of potentials: 10, number of rows: 1, number of positions: 10, number of connections: 10, product range: MSTB 2,5/..-ST, pitch: 5 mm, connection method: Screw connection with tension sleeve, screw head form: L Slotted, conductor/PCB connection direction: 0 °, locking clip: - Locking clip, plug-in system: COMBICON MSTB 2,5, locking: without, mounting: without, type of packaging: packed in cardboard

MSTB 2,5/10-STZ - PCB connector

1759004

<https://www.phoenixcontact.com/de/produkte/1759004>



PCB connector, nominal cross section: 2.5 mm², color: green, nominal current: 12 A, rated voltage (III/2): 320 V, contact surface: Tin, contact connection type: Socket, number of potentials: 10, number of rows: 1, number of positions: 10, number of connections: 10, product range: MSTB 2,5/..-STZ, pitch: 5 mm, connection method: Screw connection with tension sleeve, screw head form: L Slotted, conductor/PCB connection direction: 0 °, locking clip: - Locking clip, plug-in system: COMBICON MSTB 2,5, locking: without, mounting: without, type of packaging: packed in cardboard

MDSTBVA 2,5/10-G - PCB header

1845866

<https://www.phoenixcontact.com/de/produkte/1845866>



MSTBP 2,5/10-ST - PCB connector

1765852

<https://www.phoenixcontact.com/de/produkte/1765852>



PCB connector, nominal cross section: 2.5 mm², color: green, nominal current: 12 A, rated voltage (III/2): 320 V, contact surface: Tin, contact connection type: Socket, number of potentials: 10, number of rows: 1, number of positions: 10, number of connections: 10, product range: MSTBP 2,5/..-ST, pitch: 5 mm, connection method: Screw connection with tension sleeve, screw head form: L Slotted, conductor/PCB connection direction: 0 °, locking clip: - Locking clip, plug-in system: COMBICON MSTB 2,5, locking: without, mounting: without, type of packaging: packed in cardboard

SMSTB 2,5/10-ST - PCB connector

1768833

<https://www.phoenixcontact.com/de/produkte/1768833>



PCB connector, nominal cross section: 2.5 mm², color: green, nominal current: 12 A, rated voltage (III/2): 320 V, contact surface: Tin, contact connection type: Socket, number of potentials: 10, number of rows: 1, number of positions: 10, number of connections: 10, product range: SMSTB 2,5/..-ST, pitch: 5 mm, connection method: Screw connection with tension sleeve, screw head form: L Slotted, conductor/PCB connection direction: -45 °, locking clip: - Locking clip, plug-in system: COMBICON MSTB 2,5, locking: without, mounting: without, type of packaging: packed in cardboard

MDSTBVA 2,5/10-G - PCB header

1845866

<https://www.phoenixcontact.com/de/produkte/1845866>



FRONT-MSTB 2,5/10-ST - PCB connector

1779495

<https://www.phoenixcontact.com/de/produkte/1779495>



PCB connector, nominal cross section: 2.5 mm², color: green, nominal current: 12 A, rated voltage (III/2): 320 V, contact surface: Tin, contact connection type: Socket, number of potentials: 10, number of rows: 1, number of positions: 10, number of connections: 10, product range: FRONT-MSTB 2,5/..-ST, pitch: 5 mm, connection method: Front screw connection, screw head form: L Slotted, conductor/PCB connection direction: 0 °, locking clip: - Locking clip, plug-in system: COMBICON MSTB 2,5, locking: without, mounting: without, type of packaging: packed in cardboard

MSTBT 2,5/10-ST - PCB connector

1779916

<https://www.phoenixcontact.com/de/produkte/1779916>



PCB connector, nominal cross section: 2.5 mm², color: green, nominal current: 12 A, rated voltage (III/2): 320 V, contact surface: Tin, contact connection type: Socket, number of potentials: 10, number of rows: 1, number of positions: 10, number of connections: 10, product range: MSTBT 2,5/..-ST, pitch: 5 mm, connection method: Screw connection with tension sleeve, screw head form: L Slotted, conductor/PCB connection direction: 0 °, locking clip: - Locking clip, plug-in system: COMBICON MSTB 2,5, locking: without, mounting: without, type of packaging: packed in cardboard

MDSTBVA 2,5/10-G - PCB header

1845866

<https://www.phoenixcontact.com/de/produkte/1845866>



MVSTBR 2,5/10-ST - PCB connector

1792090

<https://www.phoenixcontact.com/de/produkte/1792090>



PCB connector, nominal cross section: 2.5 mm², color: green, nominal current: 12 A, rated voltage (III/2): 320 V, contact surface: Tin, contact connection type: Socket, number of potentials: 10, number of rows: 1, number of positions: 10, number of connections: 10, product range: MVSTBR 2,5/..-ST, pitch: 5 mm, connection method: Screw connection with tension sleeve, screw head form: L Slotted, conductor/PCB connection direction: 90 °, locking clip: - Locking clip, plug-in system: COMBICON MSTB 2,5, locking: without, mounting: without, type of packaging: packed in cardboard

MVSTBW 2,5/10-ST - PCB connector

1792605

<https://www.phoenixcontact.com/de/produkte/1792605>



PCB connector, nominal cross section: 2.5 mm², color: green, nominal current: 12 A, rated voltage (III/2): 320 V, contact surface: Tin, contact connection type: Socket, number of potentials: 10, number of rows: 1, number of positions: 10, number of connections: 10, product range: MVSTBW 2,5/..-ST, pitch: 5 mm, connection method: Screw connection with tension sleeve, screw head form: L Slotted, conductor/PCB connection direction: -90 °, locking clip: - Locking clip, plug-in system: COMBICON MSTB 2,5, locking: without, mounting: without, type of packaging: packed in cardboard

MDSTBVA 2,5/10-G - PCB header

1845866

<https://www.phoenixcontact.com/de/produkte/1845866>



FKCT 2,5/10-ST - PCB connector

1909294

<https://www.phoenixcontact.com/de/produkte/1909294>



PCB connector, nominal cross section: 2.5 mm², color: green, nominal current: 12 A, rated voltage (III/2): 320 V, contact surface: Tin, contact connection type: Socket, number of potentials: 10, number of rows: 1, number of positions: 10, number of connections: 10, product range: FKCT 2,5/..-ST, pitch: 5 mm, connection method: Push-in spring connection, conductor/PCB connection direction: 0 °, locking clip: - Locking clip, plug-in system: COMBICON MSTB 2,5, locking: without, mounting: without, type of packaging: packed in cardboard

FKCVR 2,5/10-ST - PCB connector

1909799

<https://www.phoenixcontact.com/de/produkte/1909799>

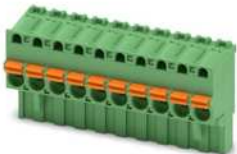

PCB connector, nominal cross section: 2.5 mm², color: green, nominal current: 12 A, rated voltage (III/2): 320 V, contact surface: Tin, contact connection type: Socket, number of potentials: 10, number of rows: 1, number of positions: 10, number of connections: 10, product range: FKCVR 2,5/..-ST, pitch: 5 mm, connection method: Push-in spring connection, conductor/PCB connection direction: 90 °, locking clip: - Locking clip, plug-in system: COMBICON MSTB 2,5, locking: without, mounting: without, type of packaging: packed in cardboard

MDSTBVA 2,5/10-G - PCB header

1845866

<https://www.phoenixcontact.com/de/produkte/1845866>



FKCVW 2,5/10-ST - PCB connector

1910115

<https://www.phoenixcontact.com/de/produkte/1910115>

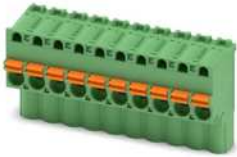

PCB connector, nominal cross section: 2.5 mm², color: green, nominal current: 12 A, rated voltage (III/2): 320 V, contact surface: Tin, contact connection type: Socket, number of potentials: 10, number of rows: 1, number of positions: 10, number of connections: 10, product range: FKCVW 2,5/...-ST, pitch: 5 mm, connection method: Push-in spring connection, conductor/PCB connection direction: -90 °, locking clip: - Locking clip, plug-in system: COMBICON MSTB 2,5, locking: without, mounting: without, type of packaging: packed in cardboard

FKC 2,5/10-ST - PCB connector

1910432

<https://www.phoenixcontact.com/de/produkte/1910432>

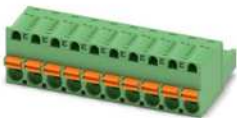

PCB connector, nominal cross section: 2.5 mm², color: green, nominal current: 12 A, rated voltage (III/2): 320 V, contact surface: Tin, contact connection type: Socket, number of potentials: 10, number of rows: 1, number of positions: 10, number of connections: 10, product range: FKC 2,5/...-ST, pitch: 5 mm, connection method: Push-in spring connection, conductor/PCB connection direction: 0 °, locking clip: - Locking clip, plug-in system: COMBICON MSTB 2,5, locking: without, mounting: without, type of packaging: packed in cardboard

MDSTBVA 2,5/10-G - PCB header

1845866

<https://www.phoenixcontact.com/de/produkte/1845866>



FKCS 2,5/10-ST - PCB connector

1974818

<https://www.phoenixcontact.com/de/produkte/1974818>



PCB connector, nominal cross section: 2.5 mm², color: green, nominal current: 12 A, rated voltage (III/2): 320 V, contact surface: Tin, contact connection type: Socket, number of potentials: 10, number of rows: 1, number of positions: 10, number of connections: 10, product range: FKCS 2,5/..-ST, pitch: 5 mm, connection method: Push-in spring connection, conductor/PCB connection direction: 0 °, locking clip: - Locking clip, plug-in system: COMBICON MSTB 2,5, locking: without, mounting: without, type of packaging: packed in cardboard

Phoenix Contact 2023 © - all rights reserved

<https://www.phoenixcontact.com>

PHOENIX CONTACT Deutschland GmbH

Flachsmarktstraße 8

D-32825 Blomberg

+49 52 35/3-1 20 00

info@phoenixcontact.de