

DFMC 0,5/13-ST-2,54 - PCB connector



1844688

<https://www.phoenixcontact.com/pc/products/1844688>

Please be informed that the data shown in this PDF document is generated from our Online Catalog. Please find the complete data in the user documentation. Our General Terms of Use for Downloads are valid.

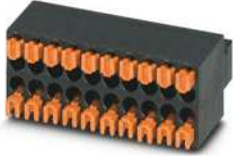

PCB connector, nominal cross section: 0.5 mm², color: black, nominal current: 6 A, rated voltage (III/2): 160 V, contact surface: Gold, type of contact: Socket, number of potentials: 26, number of rows: 2, number of positions: 13, number of connections: 26, product range: DFMC 0,5/...-ST, pitch: 2.54 mm, connection method: Push-in spring connection, conductor/PCB connection direction: 0 °, plug-in system: COMBICON DFMC 0,5, locking: without, mounting: without, type of packaging: packed in cardboard

Your advantages

- Gold-plated contacts ensure transfer quality remains stable over the long term
- Time saving push-in connection, tools not required
- Defined contact force ensures that contact remains stable over the long term
- Intuitive use through colour coded actuation lever
- Optimized for tight installation situations: operation and conductor connection from one direction

Commercial Data

Item number	1844688
Packing unit	50 pc
Minimum order quantity	1 pc
Product Key	AAAFDA
GTIN	4046356964364
Weight per Piece (including packing)	6.64 g
Weight per Piece (excluding packing)	2.22 g
Customs tariff number	85366990
Country of origin	PL

DFMC 0,5/13-ST-2,54 - PCB connector



1844688

<https://www.phoenixcontact.com/pc/products/1844688>

Technical Data

Product properties

Type	Standard
Product line	COMBICON Connectors XS
Product type	PCB connector
Product family	DFMC 0,5/..-ST
Number of positions	13
Pitch	2.54 mm
Number of connections	26
Number of rows	2
Mounting flange	without
Number of potentials	26

Electrical properties

Nominal current I_N	6 A
Nominal voltage U_N	160 V
Degree of pollution	3
Contact resistance	2.7 m Ω
Rated voltage (III/3)	32 V
Rated surge voltage (III/3)	2.5 kV
Rated voltage (III/2)	160 V
Rated surge voltage (III/2)	2.5 kV
Rated voltage (II/2)	160 V
Rated surge voltage (II/2)	2.5 kV

Connection data

Connection technology

Type	Standard
Connector system	COMBICON DFMC 0,5
Nominal cross section	0.5 mm ²
Type of contact	Socket

Interlock

Locking type	without
Mounting flange	without

Conductor connection

Connection method	Push-in spring connection
Conductor/PCB connection direction	0 °
Conductor cross section rigid	0.14 mm ² ... 0.5 mm ²
Conductor cross section flexible	0.14 mm ² ... 0.5 mm ²
Conductor cross section AWG	26 ... 20
Conductor cross section flexible, with ferrule without plastic	0.25 mm ² ... 0.34 mm ²

DFMC 0,5/13-ST-2,54 - PCB connector

1844688

<https://www.phoenixcontact.com/pc/products/1844688>

sleeve	
Conductor cross section, flexible, with ferrule, with plastic sleeve	0.14 mm ² ... 0.25 mm ²
Cylindrical gauge a x b / diameter	- / 1.2 mm
Stripping length	7 mm

Material specifications

Material data - contact

Note	WEEE/RoHS-compliant, free of whiskers according to IEC 60068-2-82/JEDEC JESD 201
Contact material	Cu alloy
Surface characteristics	Selective coating
Metal surface terminal point (top layer)	Tin (5 - 7 µm Sn)
Metal surface terminal point (middle layer)	Nickel (1 - 3 µm Ni)
Metal surface contact area (top layer)	Gold (0.25 Au)
Metal surface contact area (middle layer)	Nickel (2 - 3 µm Ni)

Material data - housing

Color (Housing)	black (9005)
Insulating material	LCP
Insulating material group	IIIa
CTI according to IEC 60112	175
Flammability rating according to UL 94	V0

Material data - actuating element

Color (Actuating element)	orange (2003)
Insulating material	LCP
Insulating material group	IIIa
CTI according to IEC 60112	175
Flammability rating according to UL 94	V0

Dimensions

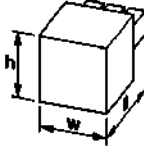
Dimensional drawing	
Pitch	2.54 mm
Width [w]	33.52 mm
Height [h]	10.5 mm
Length [l]	15.85 mm

Mounting

Connection method	Push-in spring connection
-------------------	---------------------------

Mechanical tests

Conductor connection

Specification	IEC 60999-1:1999-11
Result	Test passed

Test for conductor damage and slackening

Specification	IEC 60999-1:1999-11
Result	Test passed

Repeated connection and disconnection

Specification	IEC 60999-1:1999-11
Result	Test passed

Pull-out test

Specification	IEC 60999-1:1999-11
Conductor cross section/conductor type/tractive force setpoint/actual value	0.14 mm ² / solid / > 10 N
	0.14 mm ² / flexible / > 10 N
	0.5 mm ² / solid / > 20 N
	0.5 mm ² / flexible / > 20 N

Insertion and withdrawal forces

Result	Test passed
No. of cycles	100
Insertion strength per pos. approx.	2 N
Withdraw strength per pos. approx.	1 N

Resistance of inscriptions

Specification	IEC 60068-2-70:1995-12
Result	Test passed

Polarization and coding

Specification	IEC 60512-13-5:2006-02
Result	Test passed

Visual inspection

Specification	IEC 60512-1-1:2002-02
Result	Test passed

Dimension check

Specification	IEC 60512-1-2:2002-02
Result	Test passed

Environmental and real-life conditions

Vibration test

Specification	IEC 60068-2-6:2007-12
Frequency	10 - 500 - 10 Hz

DFMC 0,5/13-ST-2,54 - PCB connector



1844688

<https://www.phoenixcontact.com/pc/products/1844688>

Sweep speed	1 octave/min
Amplitude	0.35 mm (10 Hz ... 60.1 Hz)
Sweep speed	5g (60.1 Hz ... 500 Hz)
Test duration per axis	2 h

Durability test

Specification	IEC 60512-9-1:2010-03
Impulse withstand voltage at sea level	2.95 kV
Contact resistance R ₁	2.7 mΩ
Contact resistance R ₂	2.9 mΩ
Contact resistance R ₂ 2nd level	3.1 mΩ
Insertion/withdrawal cycles	100
Insulation resistance, neighboring positions	> 5 MΩ

Climatic test

Specification	DIN 50018:2013-05
Corrosive stress	1.0 dm ³ SO ₂ on 300 dm ³ /40 °C/3 cycles
Thermal stress	100 °C/168 h
Power-frequency withstand voltage	1.39 kV

Ambient conditions

Ambient temperature (operation)	-40 °C ... 100 °C (dependent on the derating curve)
Ambient temperature (storage/transport)	-40 °C ... 70 °C
Relative humidity (storage/transport)	30 % ... 70 %
Ambient temperature (assembly)	-5 °C ... 100 °C

Electrical tests

Thermal test | Test group C

Specification	IEC 60512-5-1:2002-02
Tested number of positions	16

Insulation resistance

Specification	IEC 60512-3-1:2002-02
Insulation resistance, neighboring positions	> 5 MΩ

Temperature cycles

Specification	IEC 60999-1:1999-11
Result	Test passed

Air clearances and creepage distances |

Specification	IEC 60664-1:2007-04
Insulating material group	IIIa
Comparative tracking index (IEC 60112)	CTI 175
Rated insulation voltage (III/3)	32 V
Rated surge voltage (III/3)	2.5 kV
minimum clearance value - non-homogenous field (III/3)	1.5 mm

DFMC 0,5/13-ST-2,54 - PCB connector



1844688

<https://www.phoenixcontact.com/pc/products/1844688>

minimum creepage distance (III/3)	1.3 mm
Rated insulation voltage (III/2)	160 V
Rated surge voltage (III/2)	2.5 kV
minimum clearance value - non-homogenous field (III/2)	1.5 mm
minimum creepage distance (III/2)	1.6 mm
Rated insulation voltage (II/2)	160 V
Rated surge voltage (II/2)	2.5 kV
minimum clearance value - non-homogenous field (II/2)	1.5 mm
minimum creepage distance (II/2)	1.6 mm

Drawings

Diagram

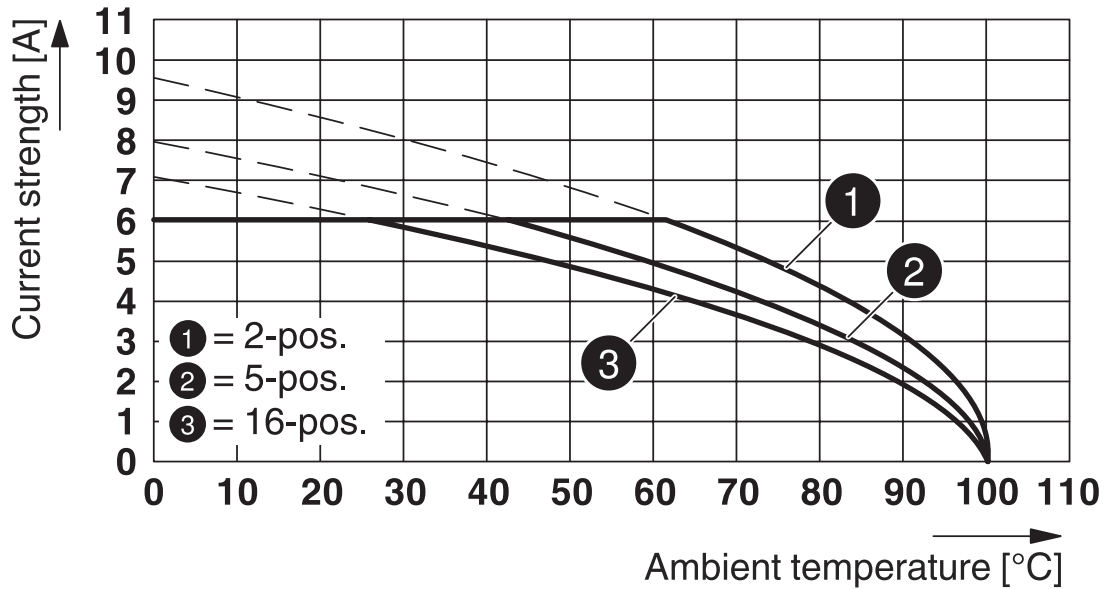

Type: DFMC 0,5/...-ST-2,54 with DMC 0,5/...-G1-2,54 P...THR R...

Diagram

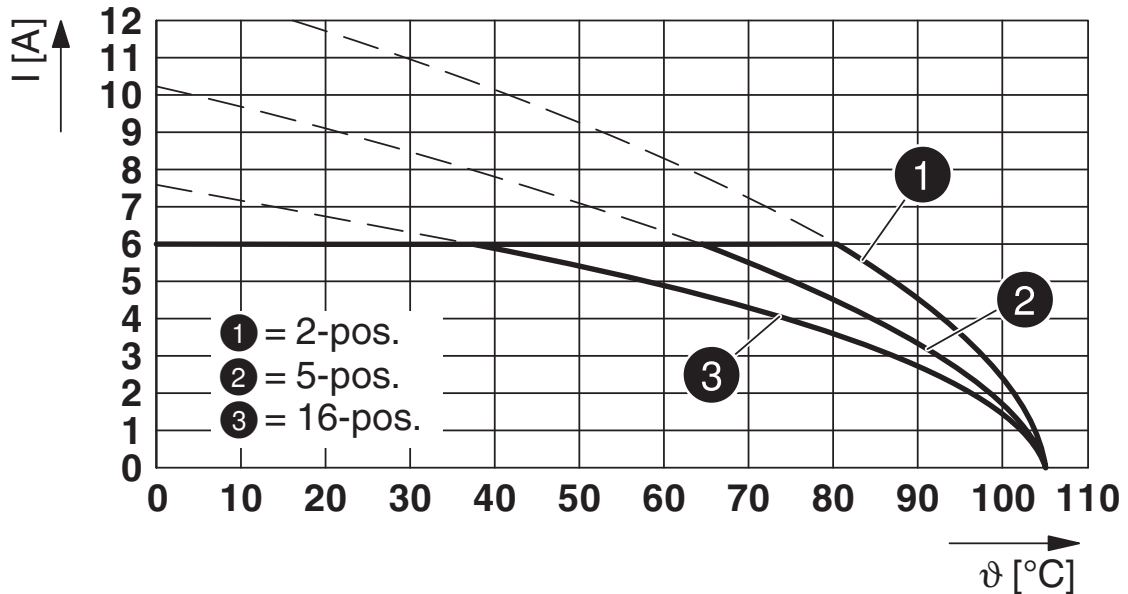

Type: DFMC 0,5/...-ST-2,54 with DMC 0,5/...-G1-2,54 SMD R...

DFMC 0,5/13-ST-2,54 - PCB connector



1844688

<https://www.phoenixcontact.com/pc/products/1844688>

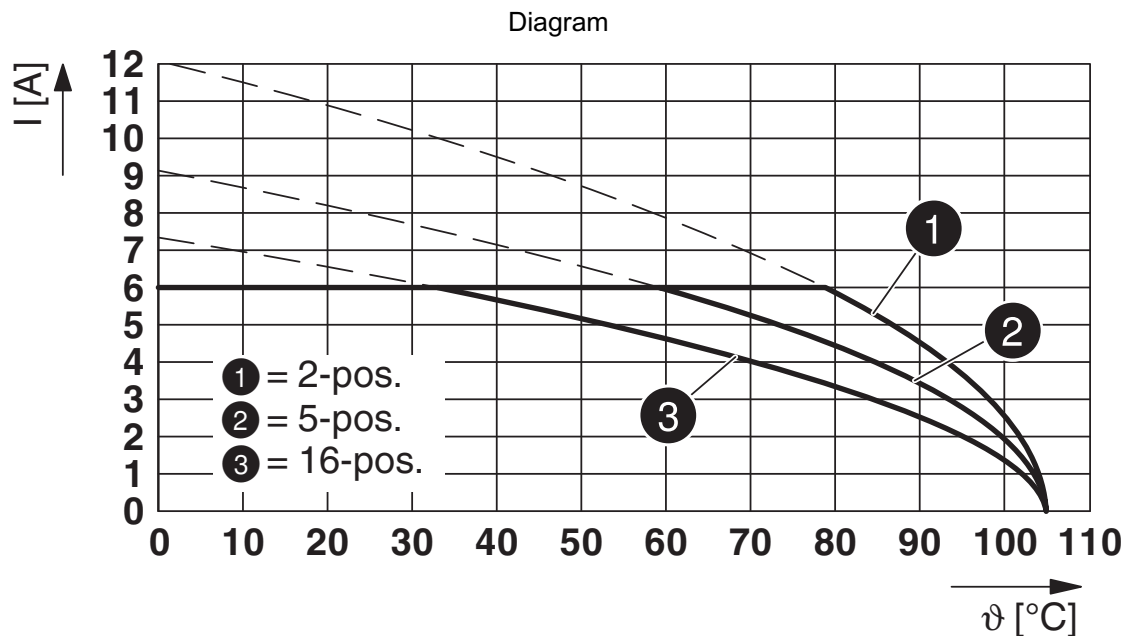

Type: DFMC 0,5/...-ST-2,54 with DMCV 0,5/...-G1-2,54 SMD R...

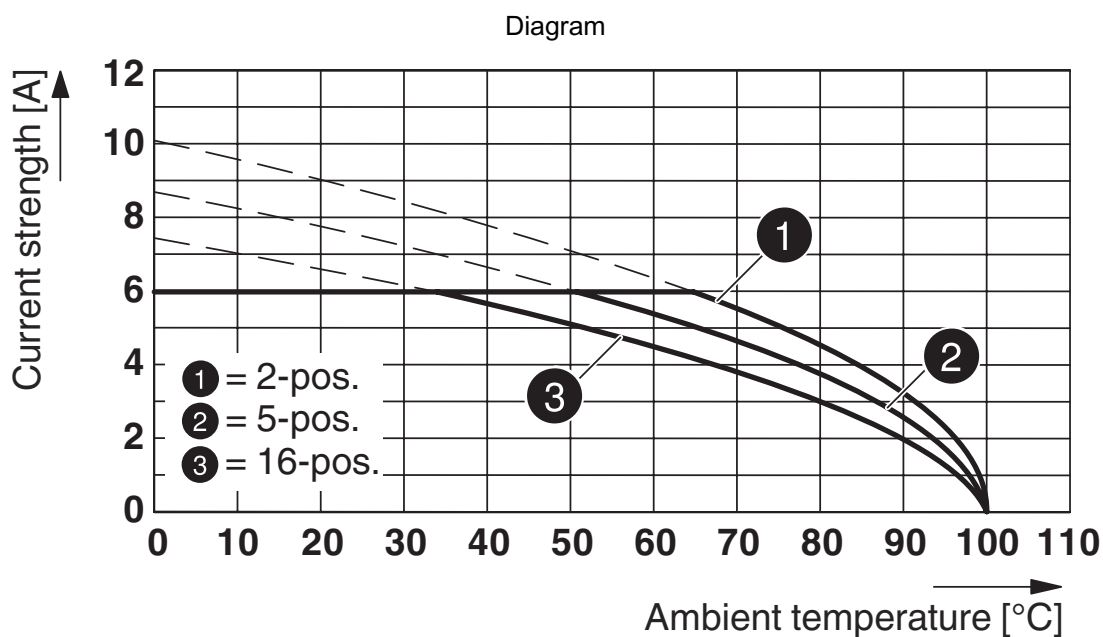

Type: DFMC 0,5/...-ST-2,54 with DMCV 0,5/...-G1-2,54 P... THRR...

DFMC 0,5/13-ST-2,54 - PCB connector



1844688

<https://www.phoenixcontact.com/pc/products/1844688>

Approvals

To download certificates, visit the product detail page: <https://www.phoenixcontact.com/pc/products/1844688>

 IECEE CB Scheme Approval ID: DE1-55740	Nominal Voltage U_N	Nominal Current I_N	Cross Section AWG	Cross Section mm^2
	160 V	6 A	-	0.14 - 0.5

 EAC Approval ID: B.01687
--

 cULus Recognized Approval ID: E60425-19920306	Nominal Voltage U_N	Nominal Current I_N	Cross Section AWG	Cross Section mm^2
Use group B				
Field wiring	150 V	5 A	26 - 20	-
Factory wiring	150 V	6 A	26 - 20	-
Use group C				
Factory wiring	50 V	6 A	26 - 20	-

 VDE Gutachten mit Fertigungsüberwachung Approval ID: 40042389	Nominal Voltage U_N	Nominal Current I_N	Cross Section AWG	Cross Section mm^2
	160 V	6 A	-	0.14 - 0.5

DFMC 0,5/13-ST-2,54 - PCB connector



1844688

<https://www.phoenixcontact.com/pc/products/1844688>

Classifications

ECLASS

ECLASS-11.0	27460202
ECLASS-12.0	27460202
ECLASS-13.0	27460202

ETIM

ETIM 8.0	EC002638
----------	----------

UNSPSC

UNSPSC 21.0	39121400
-------------	----------

DFMC 0,5/13-ST-2,54 - PCB connector



1844688

<https://www.phoenixcontact.com/pc/products/1844688>

Environmental Product Compliance

China RoHS	Environmentally friendly use period: unlimited = EFUP-e
	No hazardous substances above threshold values

DFMC 0,5/13-ST-2,54 - PCB connector

1844688

<https://www.phoenixcontact.com/pc/products/1844688>

Accessories

SZS 0,4X2,0 - Screwdriver

1205202

<https://www.phoenixcontact.com/pc/products/1205202>



Micro screwdriver, bladed, size: 0.4 x 2.0 x 60 mm, 2-component grip, with non-slip grip and twist cap

SK 2,54/2,8:FORTL.ZAHLEN - Marker card

0804853

<https://www.phoenixcontact.com/pc/products/0804853>



Marker card, white, labeled, horizontal: consecutive numbers 1 ... 10, 11 ... 20, etc. up to 91 ... 99, mounting type: adhesive, for terminal block width: 2.54 mm, lettering field size: 2.54 x 2.8 mm

DFMC 0,5/13-ST-2,54 - PCB connector

1844688

<https://www.phoenixcontact.com/pc/products/1844688>

A 0,25- 7 - Ferrule

3202478

<https://www.phoenixcontact.com/pc/products/3202478>



Ferrule, length: 7 mm, color: silver

A 0,34- 7 - Ferrule

3009202

<https://www.phoenixcontact.com/pc/products/3009202>



Ferrule, length: 7 mm, color: silver

DFMC 0,5/13-ST-2,54 - PCB connector



1844688

<https://www.phoenixcontact.com/pc/products/1844688>

CRIMPFOX 6 - Crimping pliers

1212034

<https://www.phoenixcontact.com/pc/products/1212034>



Crimping pliers, for ferrules without insulating collar according to DIN 46228 Part 1 and ferrules with insulating collar according to DIN 46228 Part 4, 0.25 mm² ... 6.0 mm², lateral entry, trapezoidal crimp

DMC 0,5/13-G1-2,54 P20THR R56 - PCB header

1844837

<https://www.phoenixcontact.com/pc/products/1844837>



PCB headers, nominal cross section: 0.5 mm², color: black, nominal current: 6 A, rated voltage (III/2): 160 V, contact surface: Gold, type of contact: Pin, number of potentials: 26, number of rows: 2, number of positions: 13, number of connections: 26, product range: DMC 0,5/..-G1-THR, pitch: 2.54 mm, mounting: THR soldering, pin layout: Linear pinning, solder pin [P]: 2 mm, number of solder pins per potential: 1, plug-in system: COMBICON DFMC 0,5, Pin connector pattern alignment: Standard, locking: without, mounting: without, type of packaging: 56 mm wide tape, Sample values available under SAMPLE DMC...

DFMC 0,5/13-ST-2,54 - PCB connector



1844688

<https://www.phoenixcontact.com/pc/products/1844688>

DMCV 0,5/13-G1-2,54 P20THR R56 - PCB header

1844989

<https://www.phoenixcontact.com/pc/products/1844989>



PCB headers, nominal cross section: 0.5 mm², color: black, nominal current: 6 A, rated voltage (III/2): 160 V, contact surface: Gold, type of contact: Pin, number of potentials: 26, number of rows: 2, number of positions: 13, number of connections: 26, product range: DMCV 0,5/..-G1-THR, pitch: 2.54 mm, mounting: THR soldering, pin layout: Linear pinning, solder pin [P]: 2 mm, number of solder pins per potential: 1, plug-in system: COMBICON DFMC 0,5, Pin connector pattern alignment: Standard, locking: without, mounting: without, type of packaging: 56 mm wide tape, Sample values available under SAMPLE DMC...

DMC 0,5/13-G1-2,54 SMD R56 - PCB header

1845137

<https://www.phoenixcontact.com/pc/products/1845137>



PCB headers, nominal cross section: 0.5 mm², color: black, nominal current: 6 A, rated voltage (III/2): 160 V, contact surface: Gold, type of contact: Pin, number of potentials: 26, number of rows: 2, number of positions: 13, number of connections: 26, product range: DMC 0,5/..-G1-SMD, pitch: 2.54 mm, mounting: SMD soldering, pin layout: Linear pinning, solder pin [P]: 2 mm, number of solder pins per potential: 1, plug-in system: COMBICON DFMC 0,5, Pin connector pattern alignment: Standard, locking: without, mounting: without, type of packaging: 56 mm wide tape, Sample values available under SAMPLE DMC...

DFMC 0,5/13-ST-2,54 - PCB connector



1844688

<https://www.phoenixcontact.com/pc/products/1844688>

DMCV 0,5/13-G1-2,54 SMD R56 - PCB header

1845289

<https://www.phoenixcontact.com/pc/products/1845289>



PCB headers, nominal cross section: 0.5 mm², color: black, nominal current: 6 A, rated voltage (III/2): 160 V, contact surface: Gold, type of contact: Pin, number of potentials: 26, number of rows: 2, number of positions: 13, number of connections: 26, product range: DMCV 0,5/...-G1-SMD, pitch: 2.54 mm, mounting: SMD soldering, pin layout: Linear pinning, number of solder pins per potential: 1, plug-in system: COMBICON DFMC 0,5, Pin connector pattern alignment: Standard, locking: without, mounting: without, type of packaging: 56 mm wide tape, Sample values available under SAMPLE DMC...

Phoenix Contact 2023 © - all rights reserved

<https://www.phoenixcontact.com>

PHOENIX CONTACT GmbH & Co. KG

Flachsmarktstraße 8

D-32825 Blomberg

+49 (0) 5235-3 00

info@phoenixcontact.com