

182655-1 ✓ ACTIVE

AMP | AMP CPC

TE Internal #: 182655-1

Cable Clamp Kit, Thermoplastic, Black, Shell Size 17, .453 in [11.5 mm] Cable Entry, UL 94V-0, AMP CPC

[View on TE.com >](#)



Connectors > Connector Accessories > Connector Strain Relief > CPC Cable Clamps, Available in EMEA



Strain Relief Accessory Type: **Cable Clamp Kit**

Primary Product Material: **Thermoplastic**

Primary Product Color: **Black**

Compatible With Connector Shell Size: **17**

Cable Entry Diameter: **11.5 mm [.453 in]**

[All CPC Cable Clamps, Available in EMEA \(5\)](#)

Features

Product Type Features

Strain Relief Accessory Type	Cable Clamp Kit
------------------------------	-----------------

Body Features

Primary Product Material	Thermoplastic
Primary Product Color	Black

Mechanical Attachment

Thread Size	15/16-20
-------------	----------

Housing Features

Compatible With Connector Shape	Circular
Body Orientation	Straight

Dimensions

Cable Entry Diameter	11.5 mm [.453 in]
----------------------	-------------------

Operation/Application



Compatible With Connector Shell Size	17
Shielded	No

Industry Standards

UL Flammability Rating	UL 94V-0
------------------------	----------

Packaging Features

Packaging Method	Individual
Packaging Quantity	100

Product Compliance

[For compliance documentation, visit the product page on TE.com>](#)

EU RoHS Directive 2011/65/EU	Compliant
EU ELV Directive 2000/53/EC	Compliant
China RoHS 2 Directive MIIT Order No 32, 2016	No Restricted Materials Above Threshold
EU REACH Regulation (EC) No. 1907/2006	Current ECHA Candidate List: JAN 2024 (240) Candidate List Declared Against: JAN 2024 (240) Does not contain REACH SVHC
Halogen Content	Low Halogen - Br, Cl, F, I < 900 ppm per homogenous material. Also BFR/CFR/PVC Free
Solder Process Capability	Not applicable for solder process capability

Product Compliance Disclaimer

This information is provided based on reasonable inquiry of our suppliers and represents our current actual knowledge based on the information they provided. This information is subject to change. The part numbers that TE has identified as EU RoHS compliant have a maximum concentration of 0.1% by weight in homogenous materials for lead, hexavalent chromium, mercury, PBB, PBDE, DBP, BBP, DEHP, DIBP, and 0.01% for cadmium, or qualify for an exemption to these limits as defined in the Annexes of Directive 2011/65/EU (RoHS2). Finished electrical and electronic equipment products will be CE marked as required by Directive 2011/65/EU. Components may not be CE marked. Additionally, the part numbers that TE has identified as EU ELV compliant have a maximum concentration of 0.1% by weight in homogenous materials for lead, hexavalent chromium, and mercury, and 0.01% for cadmium, or qualify for an exemption to these limits as defined in the Annexes of Directive 2000/53/EC (ELV). Regarding the REACH Regulation, the information TE provides on SVHC in articles for this part number is based on the latest European Chemicals Agency (ECHA) 'Guidance on requirements for substances in articles' posted at this URL: <https://echa.europa.eu/guidance-documents/guidance-on-reach>

Compatible Parts



Also in the Series | AMP CPC

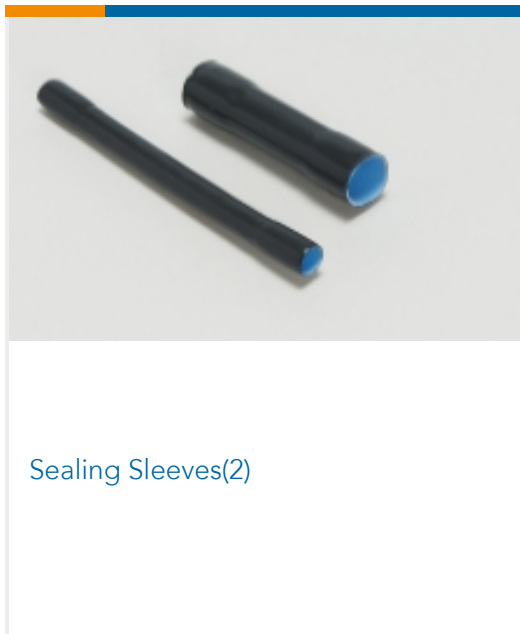
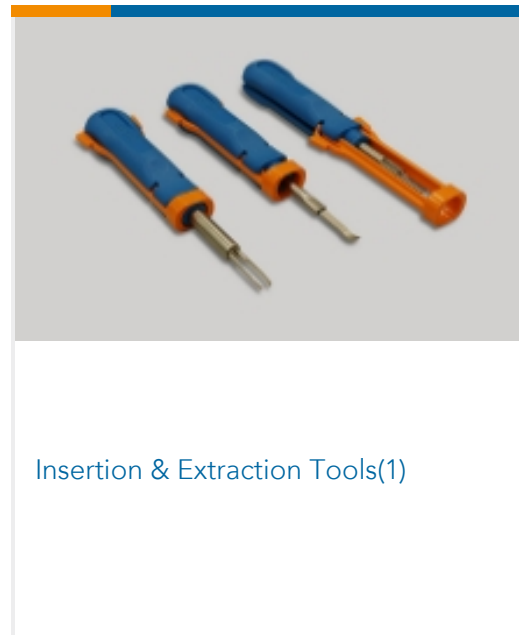
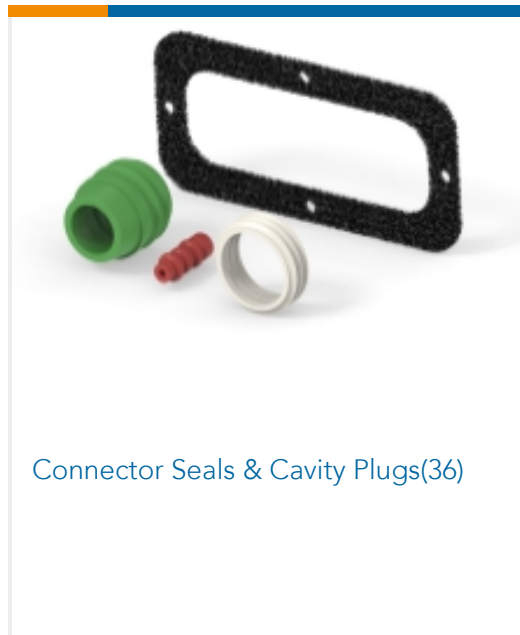
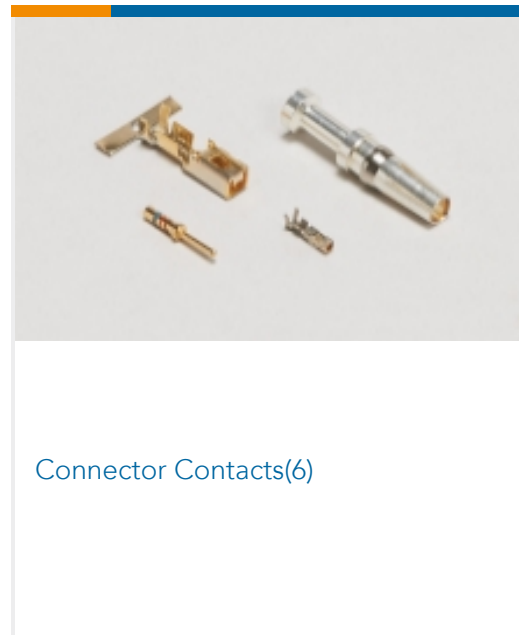
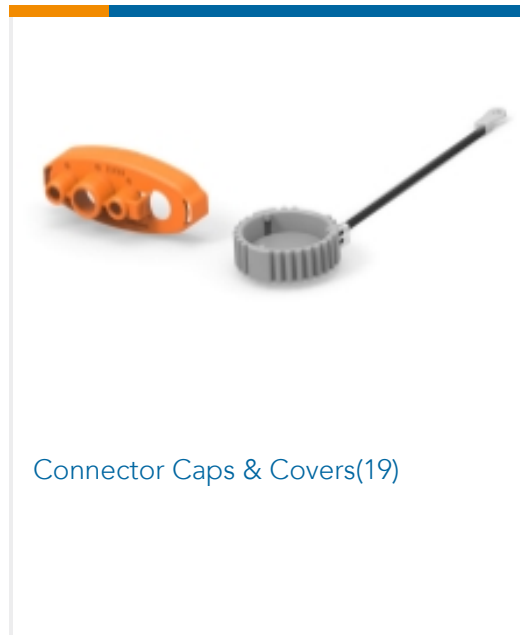
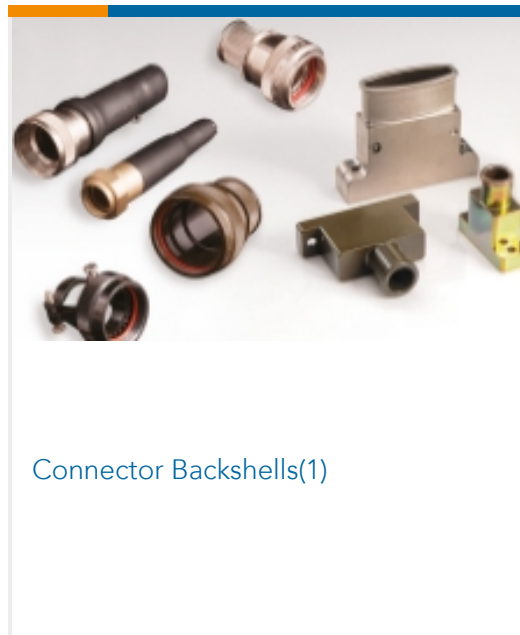
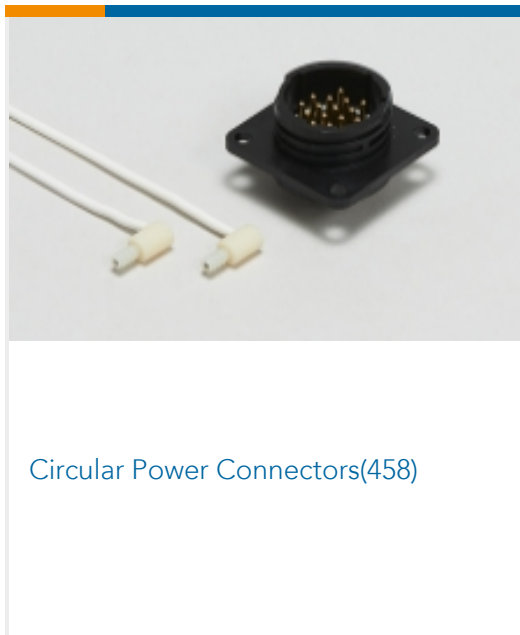

Customers Also Bought

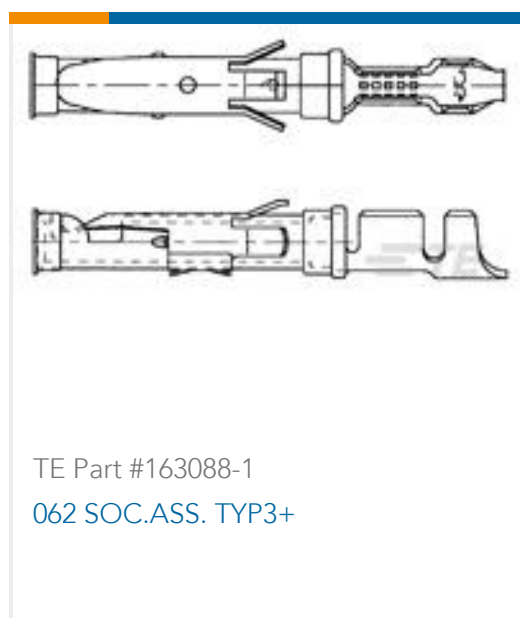

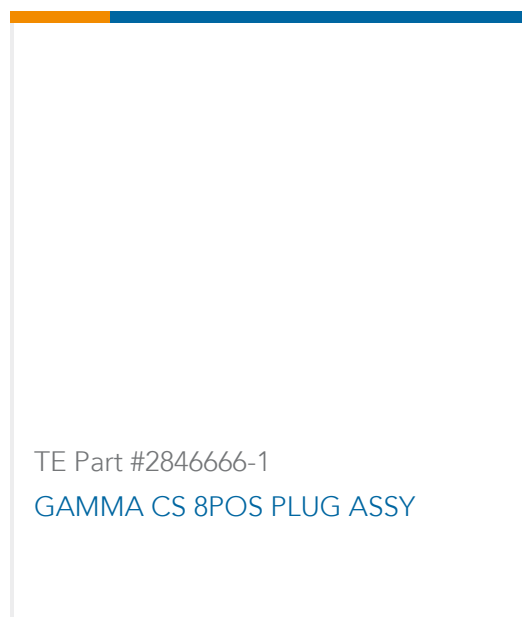

Documents

Product Drawings

[17 SIZE CPC STD CLAMP](#)

English

CAD Files

[3D PDF](#)

English

Customer View Model

[ENG_CVM_182655-1_C.2d_dxf.zip](#)

English

Customer View Model

[ENG_CVM_182655-1_C.3d_igs.zip](#)

English

Customer View Model

[ENG_CVM_182655-1_C.3d_stp.zip](#)

English

By downloading the CAD file I accept and agree to the [Terms and Conditions](#) of use.