

Printed-circuit board connector - MC 0,5/ 3-G-2,54 P20 THR R24 - 1821258

Please be informed that the data shown in this PDF Document is generated from our Online Catalog. Please find the complete data in the user's documentation. Our General Terms of Use for Downloads are valid (<http://phoenixcontact.com/download>)

PCB headers, nominal current: 6 A, number of positions: 3, pitch: 2.54 mm, color: black, contact surface: Gold, mounting: THR soldering, Sample values available under SAMPLE MC...



The figure shows the 10-position version

Your advantages

- ✓ Designed for integration into the SMT soldering process
- ✓ Additional solder anchors reduce the mechanical strain on the soldering spots
- ✓ Gold-plated contacts ensure transfer quality remains stable over the long term
- ✓ Supplied in tape-on-reel packing according to IEC 60286-3 for automated mounting

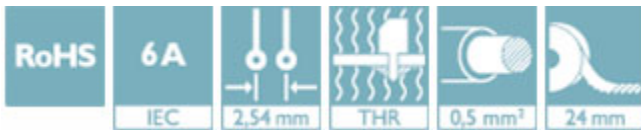

Key Commercial Data

Packing unit	1 pc
Minimum order quantity	465 pc
GTIN	 4 046356 789417
GTIN	4046356789417
Weight per Piece (excluding packing)	1.380 g
Custom tariff number	85366930
Country of origin	Poland

Technical data

Dimensions

Length [l]	7.1 mm
Width	12.2 mm
Pitch	2.54 mm
Dimension a	5.08 mm

Printed-circuit board connector - MC 0,5/ 3-G-2,54 P20 THR R24 - 1821258

Technical data

Dimensions

Width [w]	12.2 mm
Height [h]	6.85 mm
Height	4.85 mm
Length of the solder pin	2 mm
Pin dimensions	0.64 x 0.64 mm
Pin spacing	2.54 mm
Length	7.1 mm

General

Range of articles	MC 0,5/...-G-THR
Insulating material group	IIIa
Rated surge voltage (III/3)	2.5 kV
Rated surge voltage (III/2)	2.5 kV
Rated surge voltage (II/2)	2.5 kV
Rated voltage (III/3)	32 V
Rated voltage (III/2)	160 V
Rated voltage (II/2)	160 V
Connection in acc. with standard	EN-VDE
Nominal current I _N	6 A
Insulating material	LCP
Flammability rating according to UL 94	V0
Color	black
Number of positions	3

Standards and Regulations

Connection in acc. with standard	EN-VDE
Flammability rating according to UL 94	V0

Environmental Product Compliance

China RoHS	Environmentally friendly use period: unlimited = EFUP-e
	No hazardous substances above threshold values

Drawings

Printed-circuit board connector - MC 0,5/ 3-G-2,54 P20 THR R24 - 1821258

Drilling diagram

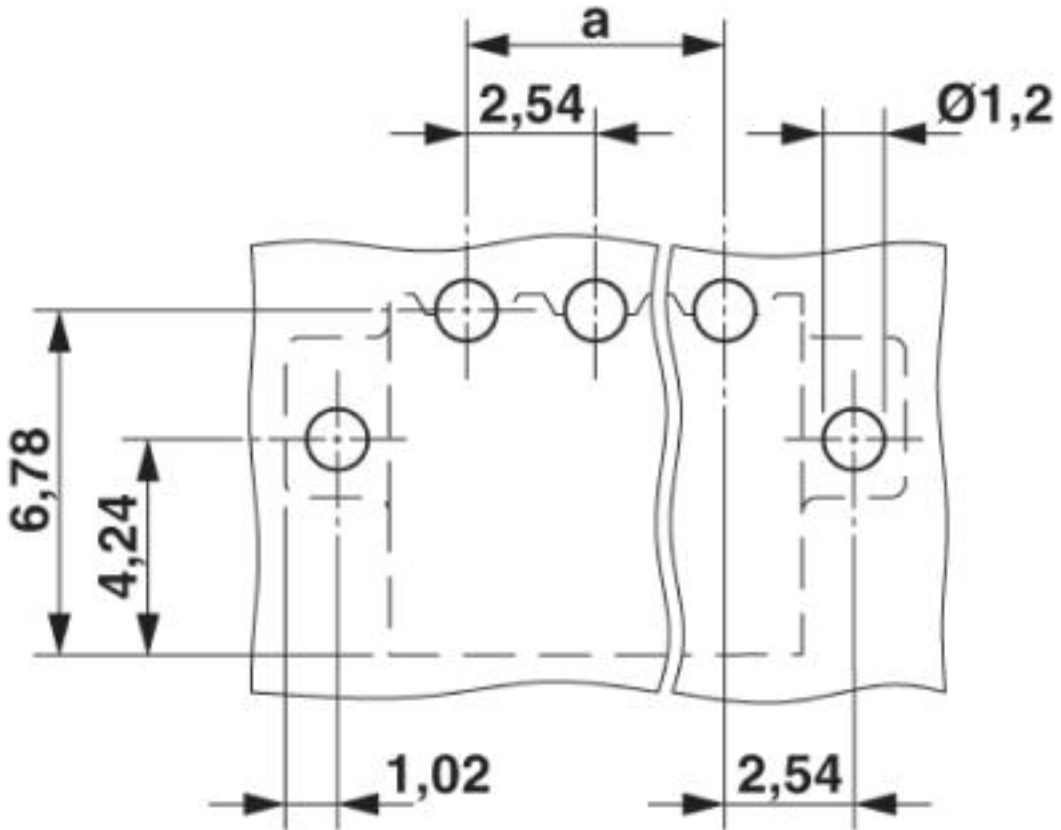

Printed-circuit board connector - MC 0,5/ 3-G-2,54 P20 THR R24 - 1821258

Diagram

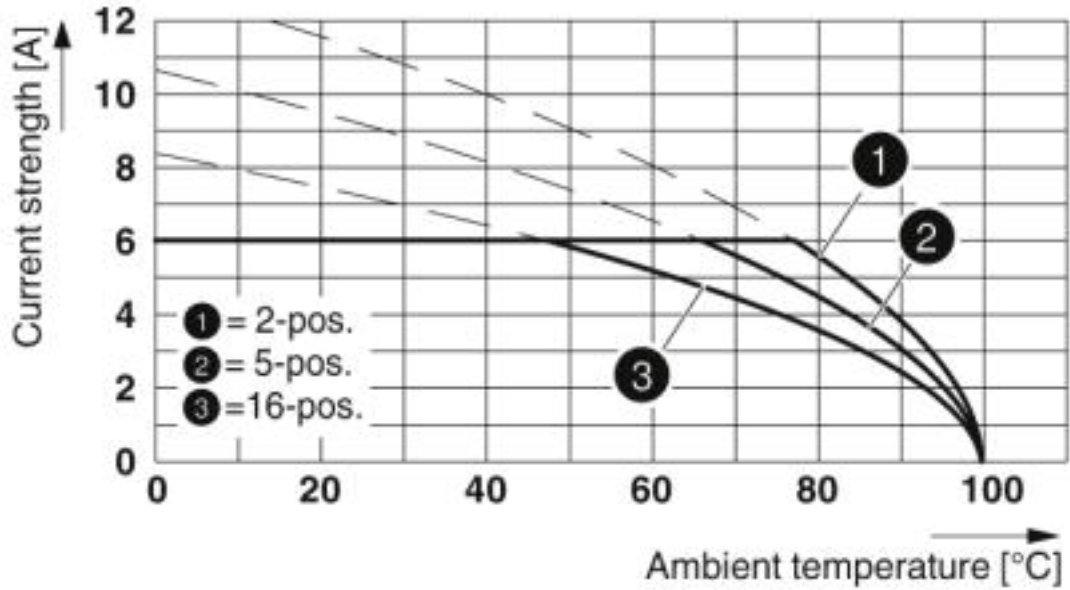

Type: FMC 0,5/...-ST-2,54 with MC 0,5/...-G-2,54 P20 THR R..

Diagram

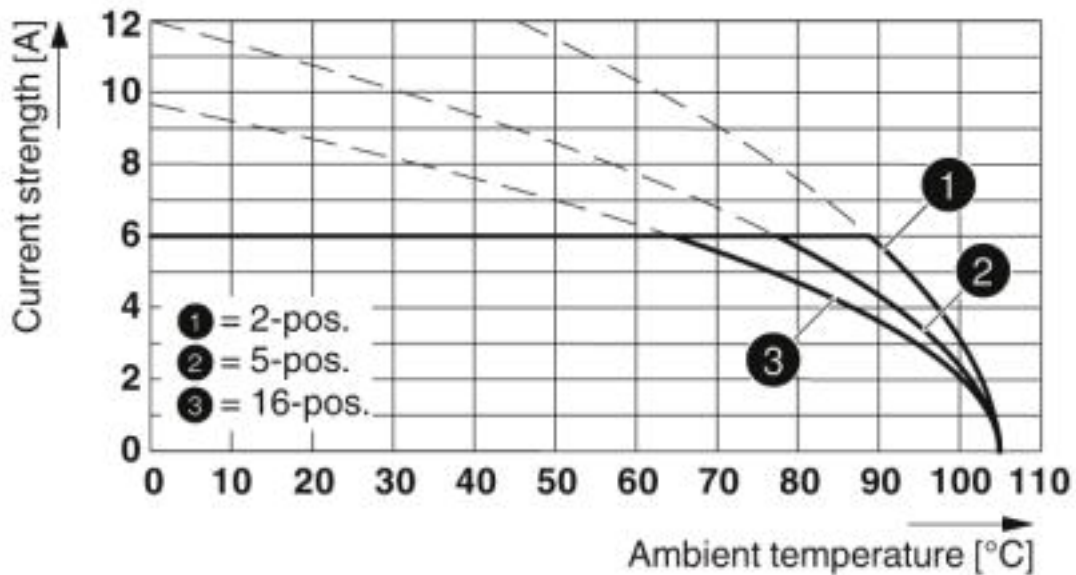

Type: MCC 0,5/...-ST-2,54 with MC 0,5/...-G-2,54 P20 THR R..

Printed-circuit board connector - MC 0,5/ 3-G-2,54 P20 THR R24 - 1821258

Dimensional drawing

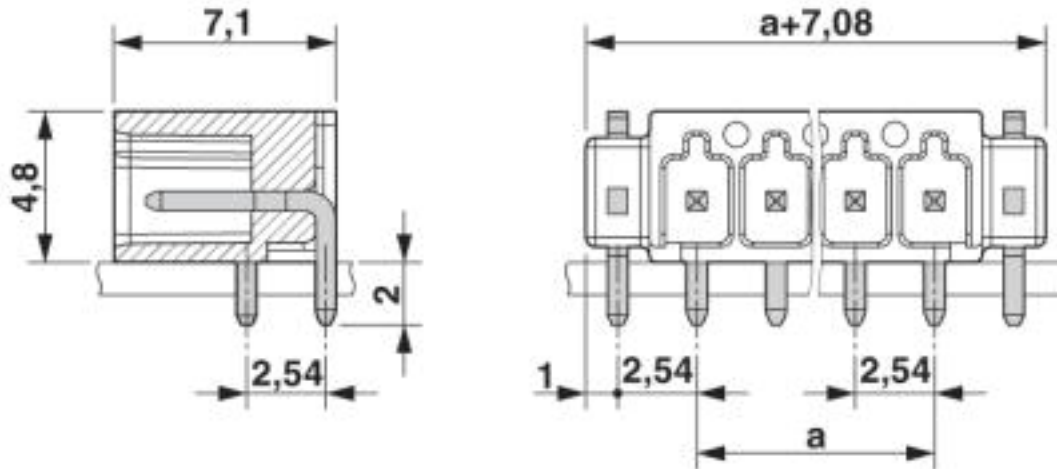

Classifications

eCl@ss

eCl@ss 4.0	27260700
eCl@ss 4.1	27260700
eCl@ss 5.0	27260700
eCl@ss 5.1	27260700
eCl@ss 6.0	27260700
eCl@ss 7.0	27440402
eCl@ss 8.0	27440402
eCl@ss 9.0	27440402

ETIM

ETIM 3.0	EC001121
ETIM 4.0	EC002637
ETIM 5.0	EC002637
ETIM 6.0	EC002637
ETIM 7.0	EC002637

UNSPSC

UNSPSC 6.01	30211810
UNSPSC 7.0901	39121409
UNSPSC 11	39121409
UNSPSC 12.01	39121409
UNSPSC 13.2	39121409

Printed-circuit board connector - MC 0,5/ 3-G-2,54 P20 THR R24 - 1821258

Approvals

Approvals

Approvals

IECEE CB Scheme / VDE Gutachten mit Fertigungsüberwachung / EAC / cULus Recognized

Ex Approvals

Approval details

IECEE CB Scheme		http://www.iecee.org/	DE1-55663-B1
Nominal voltage UN		160 V	
Nominal current IN		6 A	

VDE Gutachten mit Fertigungsüberwachung		http://www2.vde.com/de/Institut/Online-Service/VDE-gepruefteProdukte/Seiten/Online-Suche.aspx	40042258
Nominal voltage UN		160 V	
Nominal current IN		6 A	

EAC			B.01742
-----	---	--	---------

cULus Recognized		http://database.ul.com/cgi-bin/XYV/template/LISEXT/1FRAME/index.htm	E60425-19920306
Nominal voltage UN		B 150 V	C 50 V
Nominal current IN		6 A	6 A

Accessories

Accessories

Printed-circuit board connector - MC 0,5/ 3-G-2,54 P20 THR R24 - 1821258

Accessories

Labeled terminal marker

Marker card - SK 2,54/2,8:FORTL.ZAHLEN - 0804853



Marker card, Card, white, labeled, Horizontal: consecutive numbers 1 ... 10, 11 ... 20, etc. up to 91 ... 99, mounting type: adhesive, for terminal block width: 2.54 mm, lettering field size: 2.54 x 2.8 mm

PCB headers

Sample set - SAMPLE MC 0,5/ 3-G-2,54 P20THR - 1835972



PCB headers, nominal current: 6 A, number of positions: 3, pitch: 2.54 mm, color: black, contact surface: Gold, mounting: THR soldering

Additional products

Printed-circuit board connector - FMC 0,5/ 3-ST-2,54 - 1821106



PCB connector, nominal current: 6 A, number of positions: 3, pitch: 2.54 mm, connection method: Push-in spring connection, color: black, contact surface: Gold