

## Printed-circuit board connector - GMSTBVA 2,5 HC/ 3-G-7,62 - 1767979

Please be informed that the data shown in this PDF Document is generated from our Online Catalog. Please find the complete data in the user's documentation. Our General Terms of Use for Downloads are valid (<http://phoenixcontact.com/download>)

PCB headers, nominal current: 16 A, number of positions: 3, pitch: 7.62 mm, color: green, contact surface: Tin, mounting: Wave soldering



### Your advantages

- ✓ Well-known mounting principle allows worldwide use
- ✓ Larger pitch for increased voltage requirements
- ✓ Closed contour for optimum stability of the plug-in connection
- ✓ Vertical connection enables multi-row arrangement on the PCB

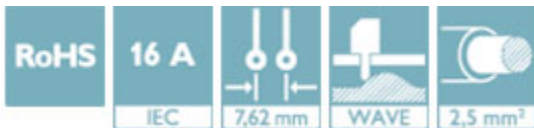

### Key Commercial Data

Packing unit	1 pc
Minimum order quantity	50 pc
GTIN	 4 046356 438483
GTIN	4046356438483
Weight per Piece (excluding packing)	4.000 g
Custom tariff number	85366930
Country of origin	Germany

### Technical data

#### Dimensions

Length [ l ]	8.6 mm
Width	22.86 mm
Pitch	7.62 mm
Dimension a	15.24 mm
Width [ w ]	22.86 mm

# Printed-circuit board connector - GMSTBVA 2,5 HC/ 3-G-7,62 - 1767979

## Technical data

### Dimensions

Height [ h ]	15.9 mm
Height	12 mm
Length of the solder pin	3.9 mm
Pin dimensions	1 x 1 mm
Length	8.6 mm

### General

Range of articles	GMSTBVA 2,5 HC/..-G
Insulating material group	I
Rated surge voltage (III/3)	6 kV
Rated surge voltage (III/2)	6 kV
Rated surge voltage (II/2)	6 kV
Rated voltage (III/3)	500 V
Rated voltage (III/2)	630 V
Rated voltage (II/2)	1000 V
Connection in acc. with standard	EN-VDE
Nominal current I <sub>N</sub>	16 A
Maximum load current	16 A
Insulating material	PA
Flammability rating according to UL 94	V0
Color	green
Number of positions	3

### Standards and Regulations

Connection in acc. with standard	EN-VDE
	CUL
Flammability rating according to UL 94	V0

### Environmental Product Compliance

China RoHS	Environmentally friendly use period: unlimited = EFUP-e
	No hazardous substances above threshold values

## Drawings

# Printed-circuit board connector - GMSTBVA 2,5 HC/ 3-G-7,62 - 1767979

Drilling diagram

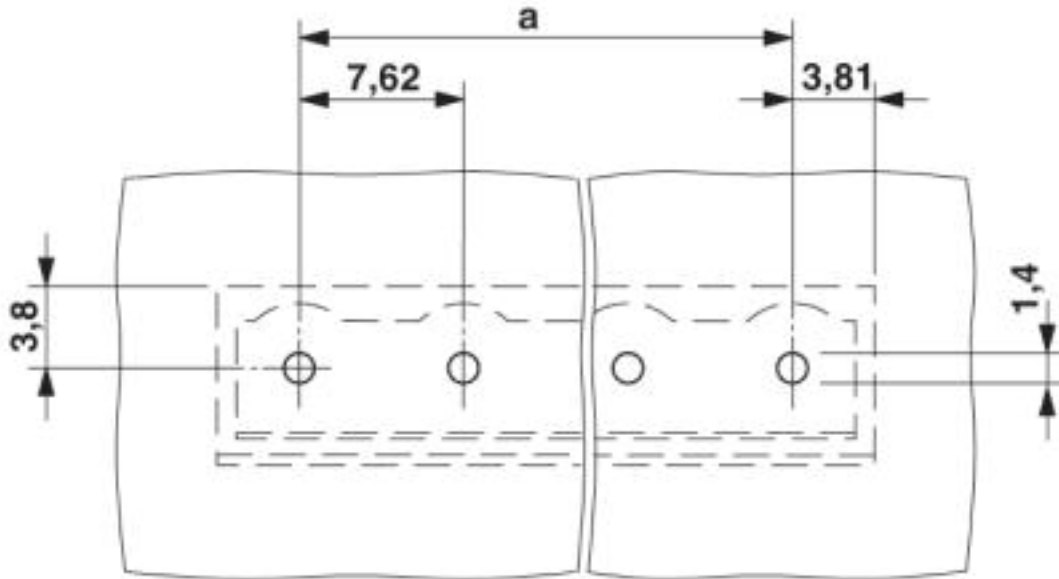

Diagram

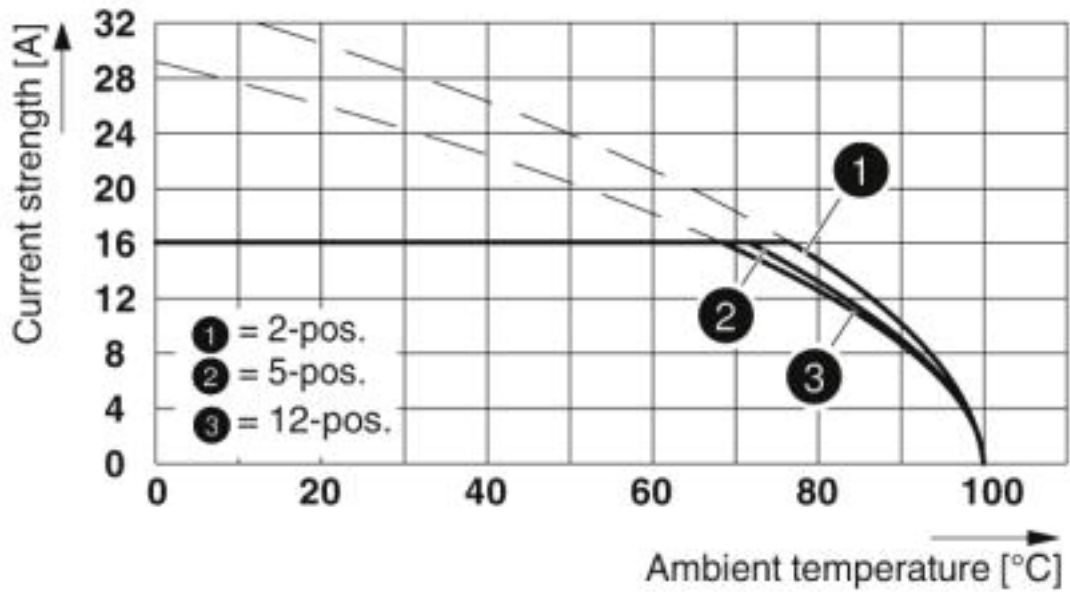

Type: GMSTB 2.5 HCV/...-ST-7.62(-LR) with GMSTBVA 2.5 HC/...-G-7.62(-LR)

# Printed-circuit board connector - GMSTBVA 2,5 HC/ 3-G-7,62 - 1767979

Dimensional drawing

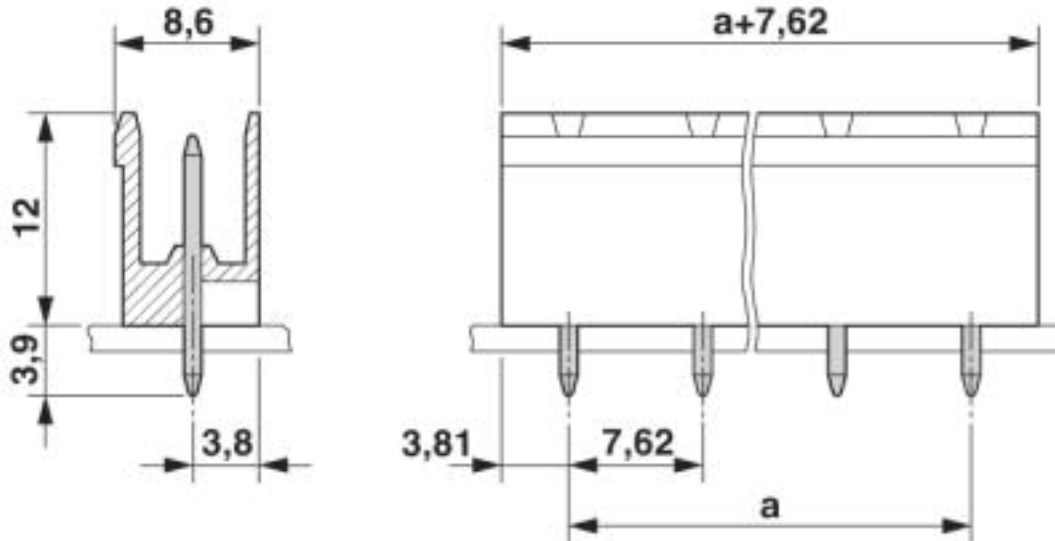

## Classifications

eCl@ss

eCl@ss 4.0	27260700
eCl@ss 4.1	27260700
eCl@ss 5.0	27260700
eCl@ss 5.1	27260700
eCl@ss 6.0	27260700
eCl@ss 7.0	27440402
eCl@ss 8.0	27440402
eCl@ss 9.0	27440402

ETIM

ETIM 3.0	EC001121
ETIM 4.0	EC002637
ETIM 5.0	EC002637
ETIM 6.0	EC002637
ETIM 7.0	EC002637

UNSPSC

UNSPSC 6.01	30211810
UNSPSC 7.0901	39121409
UNSPSC 11	39121409
UNSPSC 12.01	39121409

# Printed-circuit board connector - GMSTBVA 2,5 HC/ 3-G-7,62 - 1767979

## Classifications

### UNSPSC

UNSPSC 13.2	39121409
-------------	----------

## Approvals

### Approvals

#### Approvals

EAC / cULus Recognized / IECEE CB Scheme / VDE Zeichengenehmigung

#### Ex Approvals

## Approval details

EAC		B.01742
-----	--	---------

cULus Recognized		<a href="http://database.ul.com/cgi-bin/XYV/template/LISEXT/1FRAME/index.htm">http://database.ul.com/cgi-bin/XYV/template/LISEXT/1FRAME/index.htm</a>	E60425-19931013
	B	D	
Nominal voltage UN	300 V	300 V	
Nominal current IN	20 A	10 A	

IECEE CB Scheme		<a href="http://www.iecee.org/">http://www.iecee.org/</a>	DE1-60988-B1B2
Nominal voltage UN	400 V		
Nominal current IN	16 A		

VDE Zeichengenehmigung		<a href="http://www2.vde.com/de/Institut/Online-Service/VDE-gepruefteProdukte/Seiten/Online-Suche.aspx">http://www2.vde.com/de/Institut/Online-Service/VDE-gepruefteProdukte/Seiten/Online-Suche.aspx</a>	40050079
Nominal voltage UN	400 V		
Nominal current IN	16 A		

## Printed-circuit board connector - GMSTBVA 2,5 HC/ 3-G-7,62 - 1767979

### Accessories

#### Additional products

Plug - GMSTB 2,5 HCV/ 3-ST-7,62 - 1714281



PCB connector, nominal current: 16 A, number of positions: 3, pitch: 7.62 mm, connection method: Screw connection with tension sleeve, color: green, contact surface: Tin

---

Printed-circuit board connector - GMVSTBR 2,5 HV/ 3-ST-7,62 - 1993954



PCB connector, nominal current: 12 A, number of positions: 3, pitch: 7.62 mm, connection method: Screw connection with tension sleeve, color: green, contact surface: Tin

---

Printed-circuit board connector - GMVSTBW 2,5 HV/ 3-ST-7,62 - 1993967



PCB connector, nominal current: 12 A, number of positions: 3, pitch: 7.62 mm, connection method: Screw connection with tension sleeve, color: green, contact surface: Tin

---