

176275-2 ✓ ACTIVE

AMP Universal Power

TE Internal #: 176275-2

Rectangular Power Connectors, Housing, Plug, Wire-to-Wire, 8 Position, 3.96 mm [.156 in] Centerline, Wire & Cable, UL 94V-0, AMP Universal Power

[View on TE.com >](#)



Connectors > Power Connectors > Rectangular Power > Rectangular Power Connectors

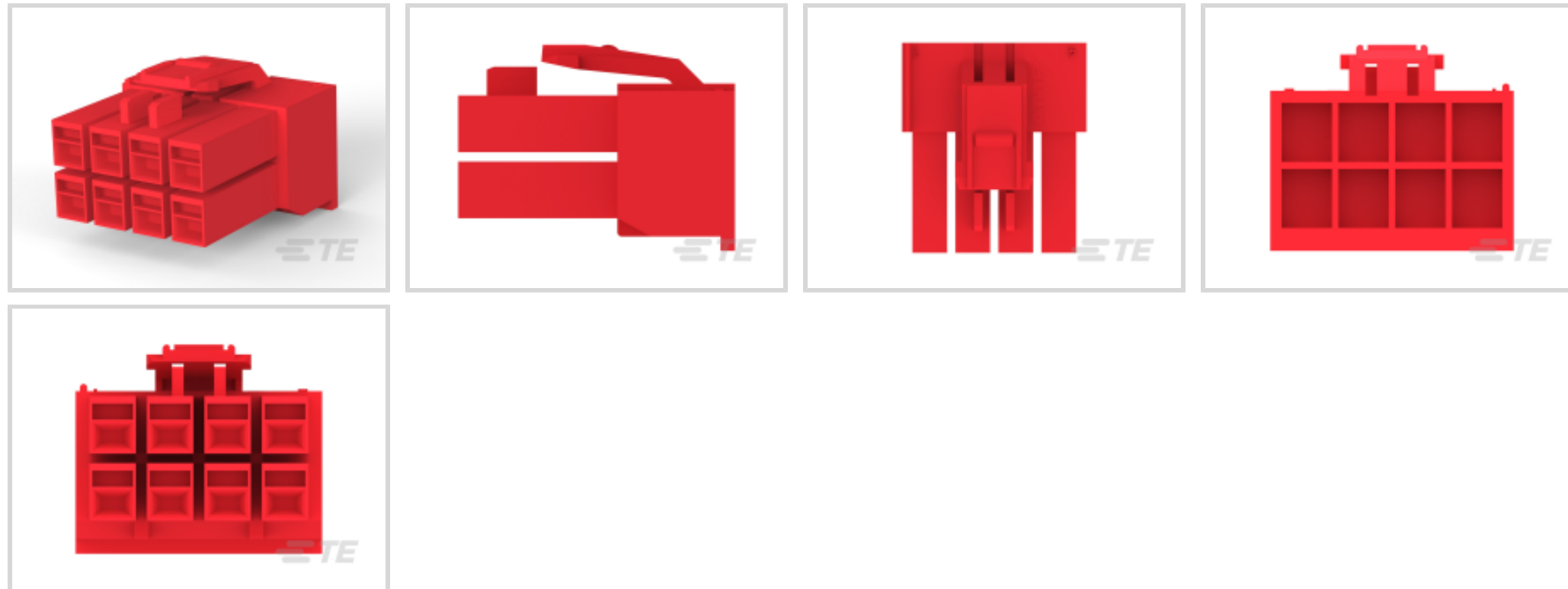

Rectangular Power Connector Type: **Housing**

Connector & Housing Type: **Plug**

Connector System: **Wire-to-Wire**

Number of Positions: **8**

Centerline (Pitch): **3.96 mm [.156 in]**

### Features

#### Product Type Features

Rectangular Power Connector Type	Housing
Connector & Housing Type	Plug
Connector System	Wire-to-Wire
Sealable	No
Connector & Contact Terminates To	Wire & Cable

#### Configuration Features

Number of Positions	8
Number of Rows	2

#### Electrical Characteristics

Insulation Resistance	1000 MΩ
Operating Voltage	300 VAC

#### Contact Features

Contact Layout	Matrix
Contact Base Material	Copper Alloy



Contact Current Rating (Max)	7 A
Contact Retention Within Housing	Without
Contact Type	Receptacle

#### Termination Features

Termination Method to Wire & Cable	Crimp
------------------------------------	-------

#### Mechanical Attachment

Strain Relief	Without
Mating Alignment Type	Polarization
Mating Retention	With
Mating Alignment	With
Panel Mount Feature	Without
PCB Mount Retention	Without
Mating Retention Type	Latch
Connector Mounting Type	Cable Mount (Free-Hanging)

#### Housing Features

Centerline (Pitch)	3.96 mm [.156 in]
Housing Color	Red
Housing Material	Nylon 6/6

#### Dimensions

Connector Height	14.35 mm [.46 in]
Product Length	19.3 mm [.76 in]
Row-to-Row Spacing	4.6 mm [.181 in]

#### Usage Conditions

Operating Temperature Range	-30 – 105 °C [-22 – 221 °F]
-----------------------------	-----------------------------

#### Operation/Application

Circuit Application	Power & Signal
---------------------	----------------

#### Industry Standards

UL Flammability Rating	UL 94V-0
Glow Wire Rating	Standard Part - Not Glow Wire

#### Packaging Features

Packaging Quantity	1000
--------------------	------



Packaging Method

Bag

### Product Compliance

[For compliance documentation, visit the product page on TE.com>](#)

EU RoHS Directive 2011/65/EU	Compliant
EU ELV Directive 2000/53/EC	Compliant
China RoHS 2 Directive MIIT Order No 32, 2016	No Restricted Materials Above Threshold
EU REACH Regulation (EC) No. 1907/2006	Current ECHA Candidate List: JUNE 2024 (241) Candidate List Declared Against: JAN 2024 (240) Does not contain REACH SVHC
Halogen Content	BFR/CFR/PVC Free, but Br/Cl >900 ppm in other sources.
Solder Process Capability	Not applicable for solder process capability

#### Product Compliance Disclaimer

This information is provided based on reasonable inquiry of our suppliers and represents our current actual knowledge based on the information they provided. This information is subject to change. The part numbers that TE has identified as EU RoHS compliant have a maximum concentration of 0.1% by weight in homogenous materials for lead, hexavalent chromium, mercury, PBB, PBDE, DBP, BBP, DEHP, DIBP, and 0.01% for cadmium, or qualify for an exemption to these limits as defined in the Annexes of Directive 2011/65/EU (RoHS2). Finished electrical and electronic equipment products will be CE marked as required by Directive 2011/65/EU. Components may not be CE marked. Additionally, the part numbers that TE has identified as EU ELV compliant have a maximum concentration of 0.1% by weight in homogenous materials for lead, hexavalent chromium, and mercury, and 0.01% for cadmium, or qualify for an exemption to these limits as defined in the Annexes of Directive 2000/53/EC (ELV). Regarding the REACH Regulation, the information TE provides on SVHC in articles for this part number is based on the latest European Chemicals Agency (ECHA) 'Guidance on requirements for substances in articles' posted at this URL: <https://echa.europa.eu/guidance-documents/guidance-on-reach>

### Compatible Parts

 <p>TE Part # 175156-2 U/P REC CONT L/P</p>	 <p>TE Part # 176286-1 UNIV POWER CAP HSG 8P F/H</p>	 <p>TE Part # 175155-1 UNIV POWER REC CONT L/P</p>	 <p>TE Part # 175151-1 AMP UNIVERSAL POWER REC CONT.</p>
--	--	---	---



TE Part # 175152-1  
UNIVERSAL POWER REC



TE Part # 175151-2  
AMP UNIV. POWER CONN REC CONT



TE Part # 175155-2  
U/P REC CONT L/P



TE Part # 175156-1  
UNIV POWER REC CONT L/P



TE Part # 176296-1  
UNIV POWER CAP HSG 8P PANEL MT



TE Part # 175152-2  
AMP UNIV. POWER CONN REC CONT



TE Part # 175151-5  
AMP UNIVERSAL POWER CONN.REC C



TE Part # 176286-2  
UNIV POWER CAP HSG 8P F/H



TE Part # 176286-9  
UNIV POWER CAP HSG 8P F/H



TE Part # 175151-4  
UNIVESAL POWER REC CONT #26-22



TE Part # 175152-3  
UNIV POWER REC CONT



TE Part # 175152-4  
UNIVESAL POWER REC CONT #20-16

### Also in the Series | AMP Universal Power



Connector Contacts(22)



Insertion & Extraction Tools(1)



Rectangular Power Connectors(163)

### Customers Also Bought



TE Part #206070-8  
CABLE CLAMP KIT #17



TE Part #DT04-2P  
REC, 2P, GRY, N



TE Part #DT06-2S  
PLG, 2P, GRY, N



TE Part #W2S  
Wedgelocks: DEUTSCH DT

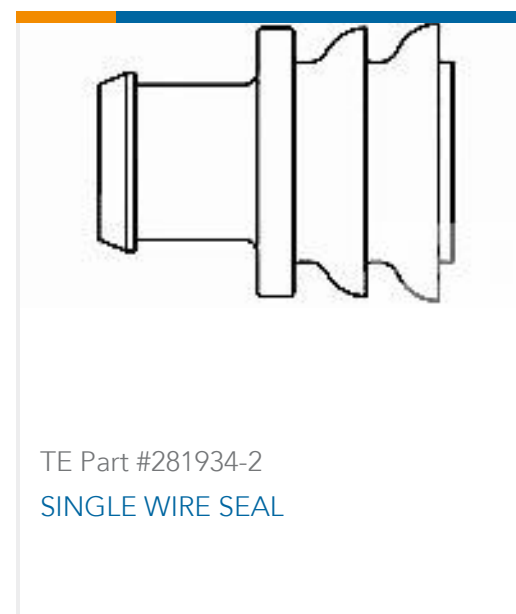

## Documents

### Product Drawings

UNIV POWER PLUG HSG 8P F/H

English

### CAD Files

3D PDF

3D

Customer View Model

[ENG\\_CVM\\_CVM\\_176275-2\\_F.2d\\_dxf.zip](#)

English

Customer View Model

[ENG\\_CVM\\_CVM\\_176275-2\\_F.3d\\_igs.zip](#)

English

Customer View Model

[ENG\\_CVM\\_CVM\\_176275-2\\_F.3d\\_stp.zip](#)

English

3D PDF

English

Customer View Model

[ENG\\_CVM\\_176275-2\\_B.3d\\_igs.zip](#)

English

Customer View Model

[ENG\\_CVM\\_176275-2\\_B.3d\\_stp.zip](#)

English

Customer View Model

[ENG\\_CVM\\_176275-2\\_B.2d\\_dxf.zip](#)

English

By downloading the CAD file I accept and agree to the [Terms and Conditions](#) of use.

### Product Specifications

Crimping of Universal Power Contact

English

Product Specification

Japanese

AMP Universal Power Connector



Japanese

---

**Instruction Sheets**

**AMP UNIVERSAL POWER CONNECTOR SERIES**

English

**Instruction Sheet (non U.S.)**

English

---

**Agency Approvals**

**UL Report**

English