

176271-6 ✓ ACTIVE



AMP Universal Power

TE Internal #: 176271-6

Rectangular Power Connectors, Housing, Plug, Wire-to-Wire, 2 Position, 3.96 mm [.156 in] Centerline, Wire & Cable, UL 94V-0, AMP Universal Power

[View on TE.com >](#)

Connectors > Power Connectors > Rectangular Power > Rectangular Power Connectors

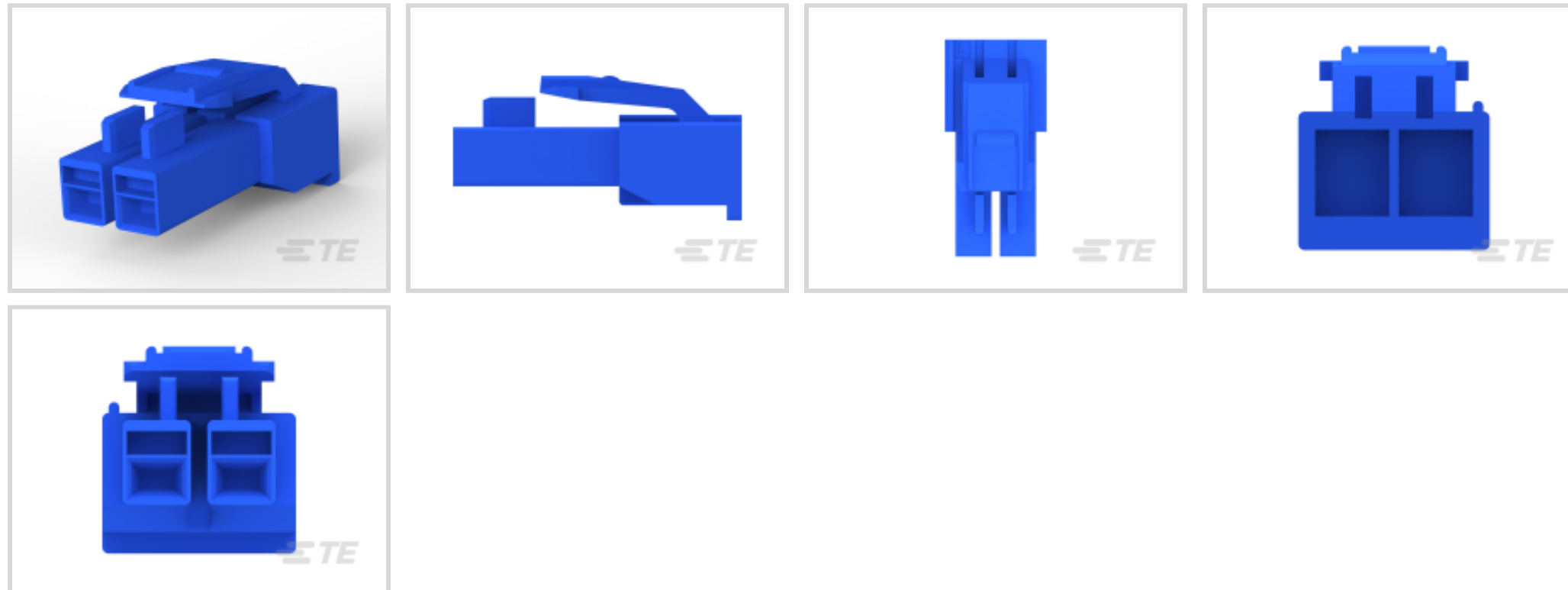

Rectangular Power Connector Type: **Housing**

Connector & Housing Type: **Plug**

Connector System: **Wire-to-Wire**

Number of Positions: **2**

Centerline (Pitch): **3.96 mm [.156 in]**

Features

Product Type Features

| | |
|-----------------------------------|--------------|
| Rectangular Power Connector Type | Housing |
| Connector & Housing Type | Plug |
| Connector System | Wire-to-Wire |
| Sealable | No |
| Connector & Contact Terminates To | Wire & Cable |

Configuration Features

| | |
|----------------------------|---|
| Number of Positions | 2 |
| Number of Power Positions | 0 |
| Number of Signal Positions | 0 |
| Number of Rows | 1 |

Electrical Characteristics

| | |
|-------------------|---------|
| Operating Voltage | 300 VAC |
|-------------------|---------|

Contact Features

| | |
|----------------|--------|
| Contact Layout | Inline |
|----------------|--------|



| | |
|----------------------------------|------------|
| Contact Retention Within Housing | Without |
| Contact Type | Receptacle |

Termination Features

| | |
|------------------------------------|-------|
| Termination Method to Wire & Cable | Crimp |
|------------------------------------|-------|

Mechanical Attachment

| | |
|-------------------------|----------------------------|
| Strain Relief | Without |
| Mating Alignment Type | Polarization |
| Mating Retention | With |
| Mating Alignment | Without |
| Panel Mount Feature | Without |
| PCB Mount Retention | Without |
| Mating Retention Type | Latch |
| Connector Mounting Type | Cable Mount (Free-Hanging) |

Housing Features

| | |
|--------------------|-------------------|
| Centerline (Pitch) | 3.96 mm [.156 in] |
| Housing Color | Blue |
| Housing Material | PA 6/6 |

Dimensions

| | |
|------------------|----------|
| Connector Height | 10.05 mm |
| Product Length | 9.06 mm |

Usage Conditions

| | |
|-----------------------------|-----------------------------|
| Operating Temperature Range | -30 – 105 °C [-22 – 221 °F] |
|-----------------------------|-----------------------------|

Operation/Application

| | |
|---------------------|----------------|
| Circuit Application | Power & Signal |
|---------------------|----------------|

Industry Standards

| | |
|------------------------|-------------------------------|
| UL Flammability Rating | UL 94V-0 |
| Glow Wire Rating | Standard Part - Not Glow Wire |

Packaging Features

| | |
|--------------------|------|
| Packaging Quantity | 1000 |
| Packaging Method | Bag |

Product Compliance



[For compliance documentation, visit the product page on TE.com>](#)

| | |
|-----------------------------------------------|---------------------------------------------------------------------------------------------------------------------------------|
| EU RoHS Directive 2011/65/EU | Compliant |
| EU ELV Directive 2000/53/EC | Compliant |
| China RoHS 2 Directive MIIT Order No 32, 2016 | No Restricted Materials Above Threshold |
| EU REACH Regulation (EC) No. 1907/2006 | Current ECHA Candidate List: JUNE 2023 (235) Candidate List Declared Against: JUNE 2023 (235) Does not contain REACH SVHC |
| Halogen Content | Low Halogen - Br, Cl, F, I < 900 ppm per homogenous material. Also BFR/CFR/PVC Free |
| Solder Process Capability | Not applicable for solder process capability |

Product Compliance Disclaimer

This information is provided based on reasonable inquiry of our suppliers and represents our current actual knowledge based on the information they provided. This information is subject to change. The part numbers that TE has identified as EU RoHS compliant have a maximum concentration of 0.1% by weight in homogenous materials for lead, hexavalent chromium, mercury, PBB, PBDE, DBP, BBP, DEHP, DIBP, and 0.01% for cadmium, or qualify for an exemption to these limits as defined in the Annexes of Directive 2011/65/EU (RoHS2). Finished electrical and electronic equipment products will be CE marked as required by Directive 2011/65/EU. Components may not be CE marked. Additionally, the part numbers that TE has identified as EU ELV compliant have a maximum concentration of 0.1% by weight in homogenous materials for lead, hexavalent chromium, and mercury, and 0.01% for cadmium, or qualify for an exemption to these limits as defined in the Annexes of Directive 2000/53/EC (ELV). Regarding the REACH Regulation, the information TE provides on SVHC in articles for this part number is based on the latest European Chemicals Agency (ECHA) 'Guidance on requirements for substances in articles' posted at this URL: <https://echa.europa.eu/guidance-documents/guidance-on-reach>

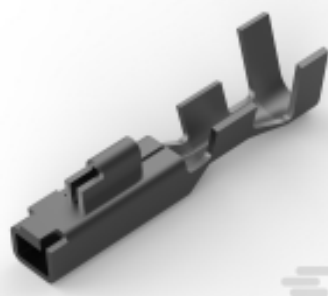
Compatible Parts

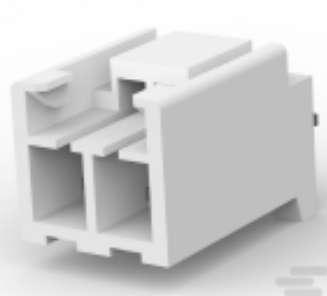
| | | | |
|------------------------------------------------------------------------------------------------------------------------------------|-------------------------------------------------------------------------------------------------------------------------------------------|--------------------------------------------------------------------------------------------------------------------------------------------|------------------------------------------------------------------------------------------------------------------------------------------------------|
|  <p>TE Part # 175156-2 U/P REC CONT L/P</p> |  <p>TE Part # 175155-1 UNIV POWER REC CONT L/P</p> |  <p>TE Part # 178495-1 UP 3.96 2P DIP HDR NAT</p> |  <p>TE Part # 9-176975-1 AMP UNIVERSAL POWER PLG 2P PCB</p> |
|------------------------------------------------------------------------------------------------------------------------------------|-------------------------------------------------------------------------------------------------------------------------------------------|--------------------------------------------------------------------------------------------------------------------------------------------|------------------------------------------------------------------------------------------------------------------------------------------------------|



TE Part # 176282-4
AMP UNIVERSAL POWER CAP 2P



TE Part # 176282-1
AMP UNIVERSAL POWER CAP 2P



TE Part # 175151-1
AMP UNIVERSAL POWER REC CONT.



TE Part # 175152-1
UNIVERSAL POWER REC



TE Part # 175151-2
AMP UNIVE. POWER CONN REC CONT



TE Part # 175155-2
U/P REC CONT L/P



TE Part # 175156-1
UNIV POWER REC CONT L/P



TE Part # 176282-2
AMP UNIVERSAL POWER CAP 2P



TE Part # 178495-9
UP 3.96 2P DIP HDR BLACK



TE Part # 176292-1
UNIV POWER CAP HSG 2P P/MOUNT



TE Part # 176282-6
AMP UNIVERSAL POWER CAP 2P



TE Part # 175152-2
AMP UNIVE. POWER CONN REC CONT



TE Part # 175151-5
AMP UNIVERSAL POWER CONN.REC C

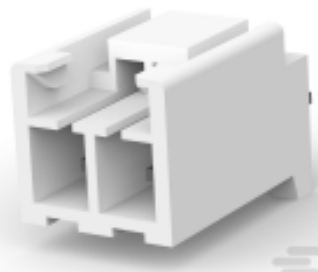

TE Part # 1-176975-1
AMP UNIVERSAL POWER PLG 2P PCB



TE Part # 1-176975-9
UNIV POWER HDR ASSY 2P BLACK



TE Part # 176975-2
UNIV POWER HDR ASSY 2P RED

Also in the Series | AMP Universal Power



Connector Contacts(22)



Insertion & Extraction Tools(1)



Rectangular Power Connectors(163)

Customers Also Bought

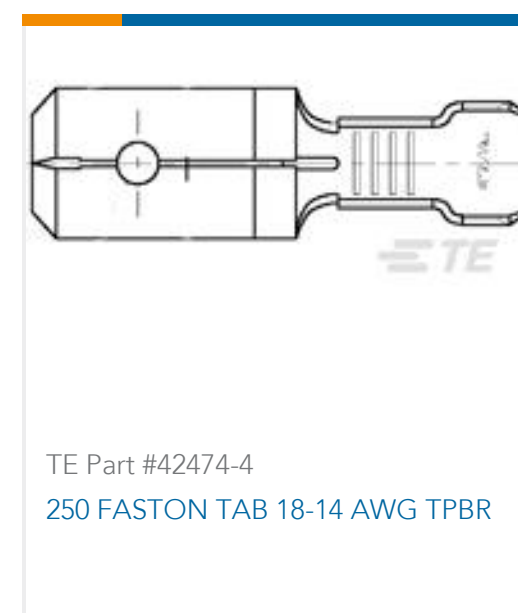

Documents

Product Drawings

AMP UNIVERSAL POWER PLUG 2P

English

CAD Files

Customer View Model

[ENG_CVM_CVM_176271-6_H.2d_dxf.zip](#)

English

3D PDF

3D

Customer View Model

[ENG_CVM_CVM_176271-6_H.3d_igs.zip](#)

English

Customer View Model

[ENG_CVM_CVM_176271-6_H.3d_stp.zip](#)

English

By downloading the CAD file I accept and agree to the [Terms and Conditions](#) of use.

Product Specifications

Crimping of Universal Power Contact

English

Product Specification

Japanese

AMP Universal Power Connector

Japanese

Instruction Sheets

AMP UNIVERSAL POWER CONNECTOR SERIES

English

Instruction Sheet (non U.S.)

English

Agency Approvals

UL Report

English

176271-6

Rectangular Power Connectors, Housing, Plug, Wire-to-Wire, 2 Position, 3.96 mm [.156 in] Centerline, Wire & Cable, UL 94V-0, AMP Universal Power

