

## Product Compliance

[For compliance documentation, visit the product page on TE.com>](#)

EU RoHS Directive 2011/65/EU	Compliant
EU ELV Directive 2000/53/EC	Compliant
China RoHS 2 Directive MIIT Order No 32, 2016	No Restricted Materials Above Threshold
EU REACH Regulation (EC) No. 1907/2006	Current ECHA Candidate List: JUNE 2023 (235) Candidate List Declared Against: JUN 2016 (169) SVHC > Threshold: Not Yet Reviewed
Halogen Content	Not Yet Reviewed for halogen content
Solder Process Capability	Not applicable for solder process capability

### Product Compliance Disclaimer

This information is provided based on reasonable inquiry of our suppliers and represents our current actual knowledge based on the information they provided. This information is subject to change. The part numbers that TE has identified as EU RoHS compliant have a maximum concentration of 0.1% by weight in homogenous materials for lead, hexavalent chromium, mercury, PBB, PBDE, DBP, BBP, DEHP, DIBP, and 0.01% for cadmium, or qualify for an exemption to these limits as defined in the Annexes of Directive 2011/65/EU (RoHS2). Finished electrical and electronic equipment products will be CE marked as required by Directive 2011/65/EU. Components may not be CE marked. Additionally, the part numbers that TE has identified as EU ELV compliant have a maximum concentration of 0.1% by weight in homogenous materials for lead, hexavalent chromium, and mercury, and 0.01% for cadmium, or qualify for an exemption to these limits as defined in the Annexes of Directive 2000/53/EC (ELV). Regarding the REACH Regulations, TE's information on SVHC in articles for this part number is still based on the European Chemical Agency (ECHA) 'Guidance on requirements for substances in articles' (Version: 2, April 2011), applying the 0.1% weight on weight concentration threshold at the finished product level. TE is aware of the European Court of Justice ruling of September 10th, 2015 also known as O5A (Once An Article Always An Article) stating that, in case of 'complex object', the threshold for a SVHC must be applied to both the product as a whole and simultaneously to each of the articles forming part of its composition. TE has evaluated this ruling based on the new ECHA "Guidance on requirements for substances in articles" (June 2017, version 4.0) and will be updating its statements accordingly.

## Compatible Parts

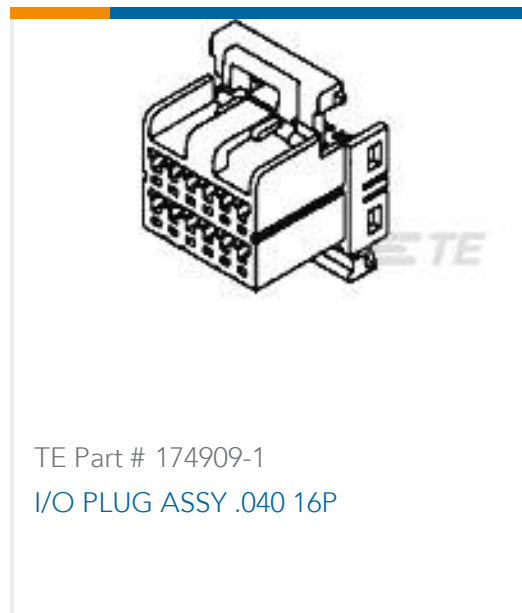

## Also in the Series | Multilock Connector System

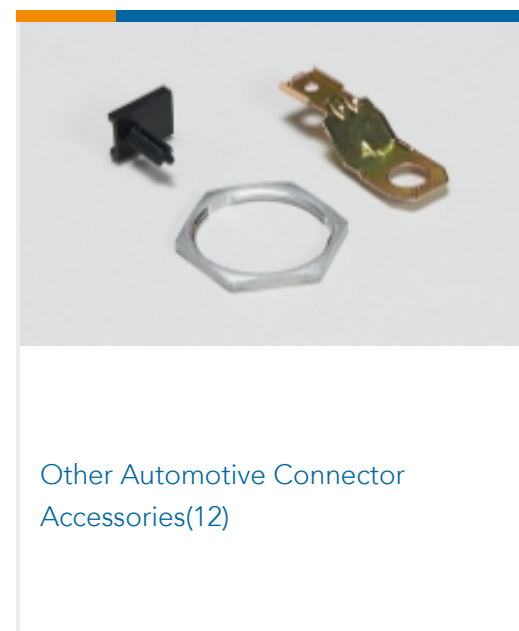
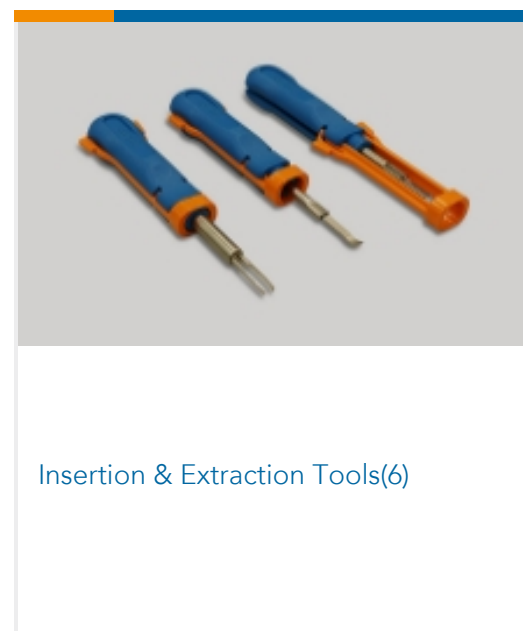
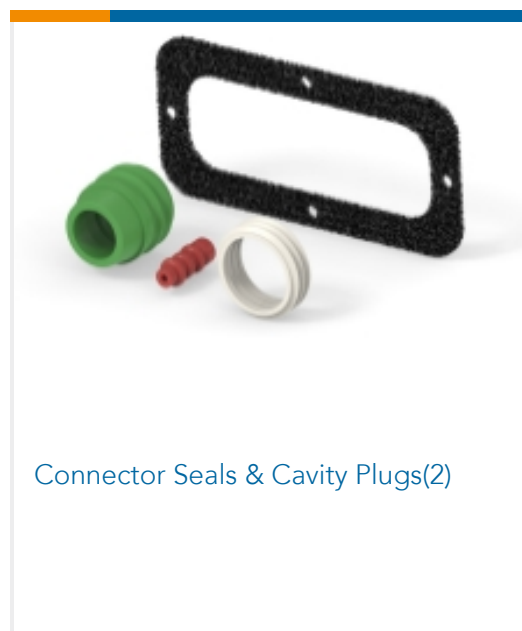
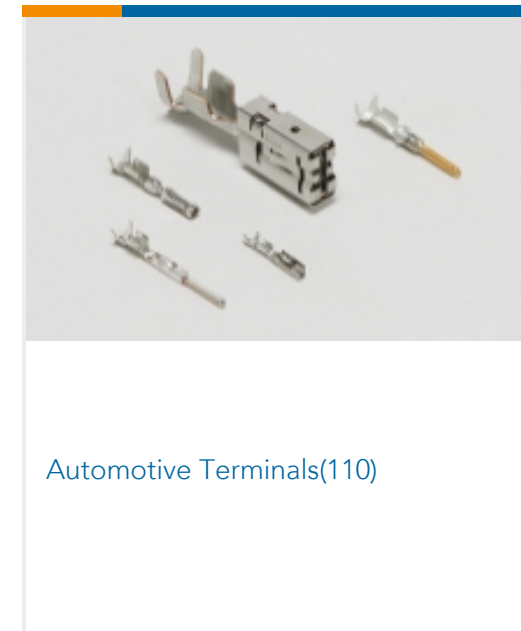
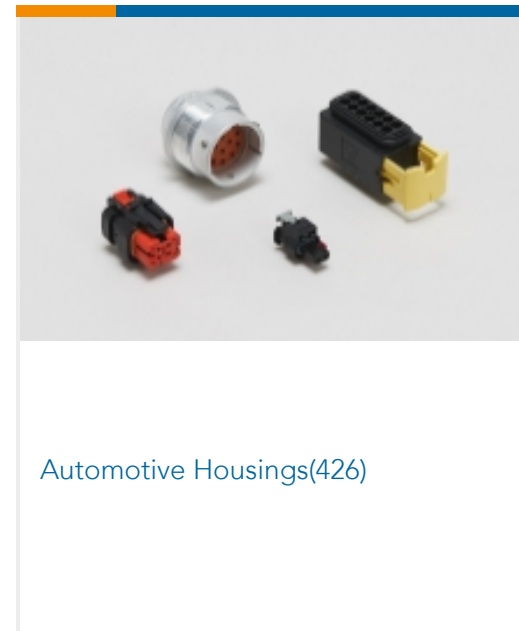
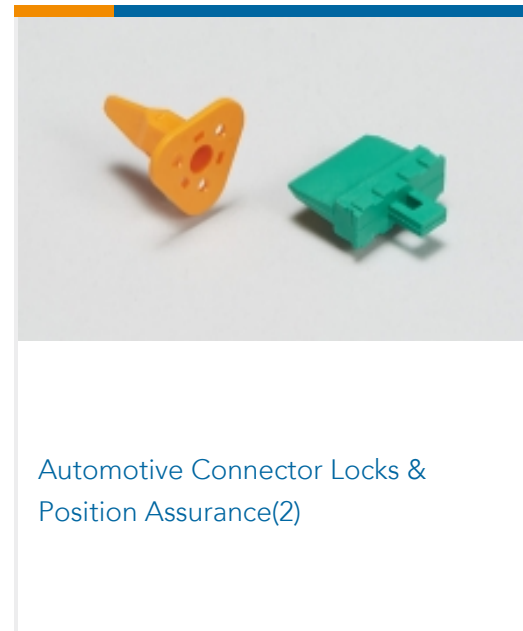
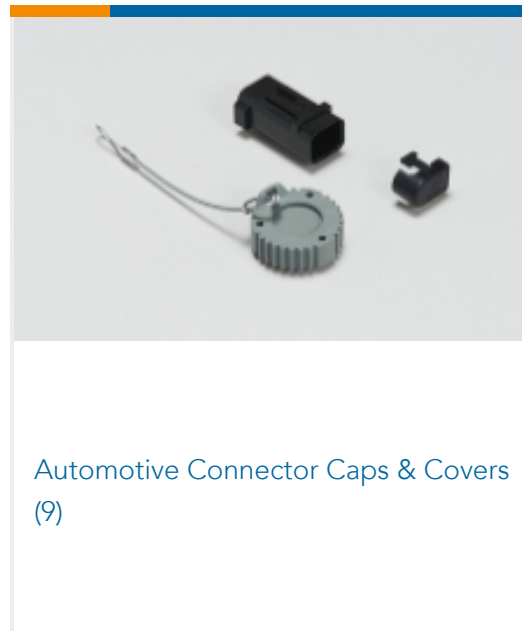

## Documents

### CAD Files

#### Customer View Model

[ENG\\_CVM\\_175615-1\\_K.3d\\_igs.zip](#)

English

#### Customer View Model

[ENG\\_CVM\\_175615-1\\_K.3d\\_stp.zip](#)

English

#### Customer View Model

[ENG\\_CVM\\_175615-1\\_K.2d\\_dxf.zip](#)

English

### 3D PDF

English

### 3D PDF

3D

#### Customer View Model



[ENG\\_CVM\\_CVM\\_175615-1\\_H.2d\\_dxf.zip](#)

English

**Customer View Model**

[ENG\\_CVM\\_CVM\\_175615-1\\_H.3d\\_igs.zip](#)

English

**Customer View Model**

[ENG\\_CVM\\_CVM\\_175615-1\\_H.3d\\_stp.zip](#)

English

By downloading the CAD file I accept and agree to the [Terms and Conditions](#) of use.

---

## Product Specifications

**Product Specification**

Japanese

**Product Specification**

English

**.040 SERIES MULTI LOCK I/O CONNECTOR (NON INERTIA TYPE)**

English

**.040 SERIES MULTI LOCK I/O CONNECTOR (NON INERTIA TYPE)**

Japanese

**Product Specification**

Japanese

---

## Instruction Sheets

**Customer Manual (non U.S.)**

Japanese

**.040 Series Multilock I/O Connector Mark II**

Japanese

**Customer Manual (non U.S.)**

Japanese

**.040 Series, Multilock I/O Connector, Mark II**

Japanese