

FKCN 2,5/16-ST - PCB connector



1732878

<https://www.phoenixcontact.com/pc/products/1732878>

Please be informed that the data shown in this PDF document is generated from our Online Catalog. Please find the complete data in the user documentation. Our General Terms of Use for Downloads are valid.



PCB connector, nominal cross section: 2.5 mm², color: green, nominal current: 12 A, rated voltage (III/2): 320 V, contact surface: Tin, type of contact: Socket, number of potentials: 16, number of rows: 1, number of positions: 16, number of connections: 16, product range: FKCN 2,5/..-ST, pitch: 5 mm, connection method: Push-in spring connection, conductor/PCB connection direction: 0 °, locking clip: - Locking clip, plug-in system: COMBICON MSTB 2,5, locking: without, mounting: without, type of packaging: packed in cardboard

Your advantages

- Time saving push-in connection, tools not required
- Intuitive use through colour coded actuation lever
- Extremely small design for the respective conductor cross section
- Defined contact force ensures that contact remains stable over the long term
- Can be combined with the MSTB 2,5 range

Commercial Data

Item number	1732878
Packing unit	50 pc
Minimum order quantity	1 pc
Product Key	AACFEA
Catalog Page	Page 278 (C-1-2013)
GTIN	4046356163873
Weight per Piece (including packing)	20.794 g
Weight per Piece (excluding packing)	20.029 g
Customs tariff number	85366990
Country of origin	BG

FKCN 2,5/16-ST - PCB connector



1732878

<https://www.phoenixcontact.com/pc/products/1732878>

Technical Data

Product properties

Type	Standard
Product line	COMBICON Connectors M
Product type	PCB connector
Product family	FKCN 2,5/...-ST
Number of positions	16
Pitch	5 mm
Number of connections	16
Number of rows	1
Mounting flange	without
Number of potentials	16

Electrical properties

Nominal current I_N	12 A
Nominal voltage U_N	320 V
Degree of pollution	3
Contact resistance	1.1 m Ω
Rated voltage (III/3)	320 V
Rated surge voltage (III/3)	4 kV
Rated voltage (III/2)	320 V
Rated surge voltage (III/2)	4 kV
Rated voltage (II/2)	630 V
Rated surge voltage (II/2)	4 kV

Connection data

Connection technology

Type	Standard
Connector system	COMBICON MSTB 2,5
Nominal cross section	2.5 mm ²
Type of contact	Socket

Interlock

Locking type	without
Mounting flange	without

Conductor connection

Connection method	Push-in spring connection
Conductor/PCB connection direction	0 °
Conductor cross section rigid	0.2 mm ² ... 1.5 mm ²
Conductor cross section flexible	0.2 mm ² ... 2.5 mm ²
Conductor cross section AWG	24 ... 16
Conductor cross section flexible, with ferrule without plastic	0.25 mm ² ... 1.5 mm ²

FKCN 2,5/16-ST - PCB connector

1732878

<https://www.phoenixcontact.com/pc/products/1732878>

sleeve	
Conductor cross section, flexible, with ferrule, with plastic sleeve	0.25 mm ² ... 1.5 mm ²
Cylindrical gauge a x b / diameter	2.4 mm x 1.5 mm / 1.6 mm
Stripping length	10 mm

Material specifications

Material data - contact

Note	WEEE/RoHS-compliant, free of whiskers according to IEC 60068-2-82/JEDEC JESD 201
Contact material	Cu alloy
Surface characteristics	hot-dip tin-plated
Metal surface terminal point (top layer)	Tin (4 - 8 µm Sn)
Metal surface contact area (top layer)	Tin (4 - 8 µm Sn)

Material data - housing

Color (Housing)	green (6021)
Insulating material	PBT
Insulating material group	I
CTI according to IEC 60112	600
Flammability rating according to UL 94	V0

Material data – actuating element

Insulating material	PA
Insulating material group	I
CTI according to IEC 60112	600
Flammability rating according to UL 94	V0

Dimensions

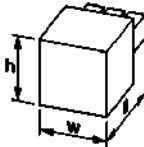
Dimensional drawing	
Pitch	5 mm
Width [w]	80 mm
Height [h]	10.9 mm
Length [l]	27.1 mm

Mounting

Connection method	Push-in spring connection
-------------------	---------------------------

Notes

Notes on operation	In accordance with IEC 61984, COMBICON connectors have no switching power (COC). During designated use, they must not be plugged in or disconnected when carrying voltage or under load.
--------------------	--

Mechanical tests

Conductor connection

Specification	IEC 60999-1:1999-11
Result	Test passed

Test for conductor damage and slackening

Specification	IEC 60999-1:1999-11
Result	Test passed

Repeated connection and disconnection

Specification	IEC 60999-1:1999-11
Result	Test passed

Pull-out test

Specification	IEC 60999-1:1999-11
Conductor cross section/conductor type/tractive force setpoint/actual value	0.2 mm ² / solid / > 10 N
	0.2 mm ² / flexible / > 10 N
	1.5 mm ² / solid / > 40 N
	2.5 mm ² / flexible / > 50 N

Insertion and withdrawal forces

Result	Test passed
No. of cycles	25
Insertion strength per pos. approx.	8 N
Withdraw strength per pos. approx.	6 N

Resistance of inscriptions

Specification	IEC 60068-2-70:1995-12
Result	Test passed

Polarization and coding

Specification	IEC 60512-13-5:2006-02
Result	Test passed

Visual inspection

Specification	IEC 60512-1-1:2002-02
Result	Test passed

Dimension check

Specification	IEC 60512-1-2:2002-02
Result	Test passed

Environmental and real-life conditions

Vibration test

Specification	IEC 60068-2-6:2007-12
Frequency	10 - 150 - 10 Hz

FKCN 2,5/16-ST - PCB connector



1732878

<https://www.phoenixcontact.com/pc/products/1732878>

Sweep speed	1 octave/min
Amplitude	0.35 mm (10 Hz ... 60.1 Hz)
Sweep speed	5g (60.1 Hz ... 150 Hz)
Test duration per axis	2.5 h

Durability test

Specification	IEC 60512-9-1:2010-03
Impulse withstand voltage at sea level	4.8 kV
Contact resistance R_1	1.1 m Ω
Contact resistance R_2	1.1 m Ω
Insertion/withdrawal cycles	25
Insulation resistance, neighboring positions	> 5 M Ω

Climatic test

Specification	ISO 6988:1985-02
Corrosive stress	0.2 dm ³ SO ₂ on 300 dm ³ /40 °C/1 cycle
Thermal stress	100 °C/168 h
Power-frequency withstand voltage	2.21 kV

Ambient conditions

Ambient temperature (operation)	-40 °C ... 100 °C (dependent on the derating curve)
Ambient temperature (storage/transport)	-40 °C ... 70 °C
Relative humidity (storage/transport)	30 % ... 70 %
Ambient temperature (assembly)	-5 °C ... 100 °C

Electrical tests

Thermal test | Test group C

Specification	IEC 60512-5-1:2002-02
Tested number of positions	18

Insulation resistance

Specification	IEC 60512-3-1:2002-02
Insulation resistance, neighboring positions	> 5 M Ω

Air clearances and creepage distances |

Specification	IEC 60664-1:2007-04
Insulating material group	I
Comparative tracking index (IEC 60112)	CTI 600
Rated insulation voltage (III/3)	320 V
Rated surge voltage (III/3)	4 kV
minimum clearance value - non-homogenous field (III/3)	3 mm
minimum creepage distance (III/3)	4 mm
Rated insulation voltage (III/2)	320 V
Rated surge voltage (III/2)	4 kV
minimum clearance value - non-homogenous field (III/2)	3 mm
minimum creepage distance (III/2)	3 mm

FKCN 2,5/16-ST - PCB connector



1732878

<https://www.phoenixcontact.com/pc/products/1732878>

Rated insulation voltage (II/2)	630 V
Rated surge voltage (II/2)	4 kV
minimum clearance value - non-homogenous field (II/2)	3 mm
minimum creepage distance (II/2)	3.2 mm

Drawings

Diagram

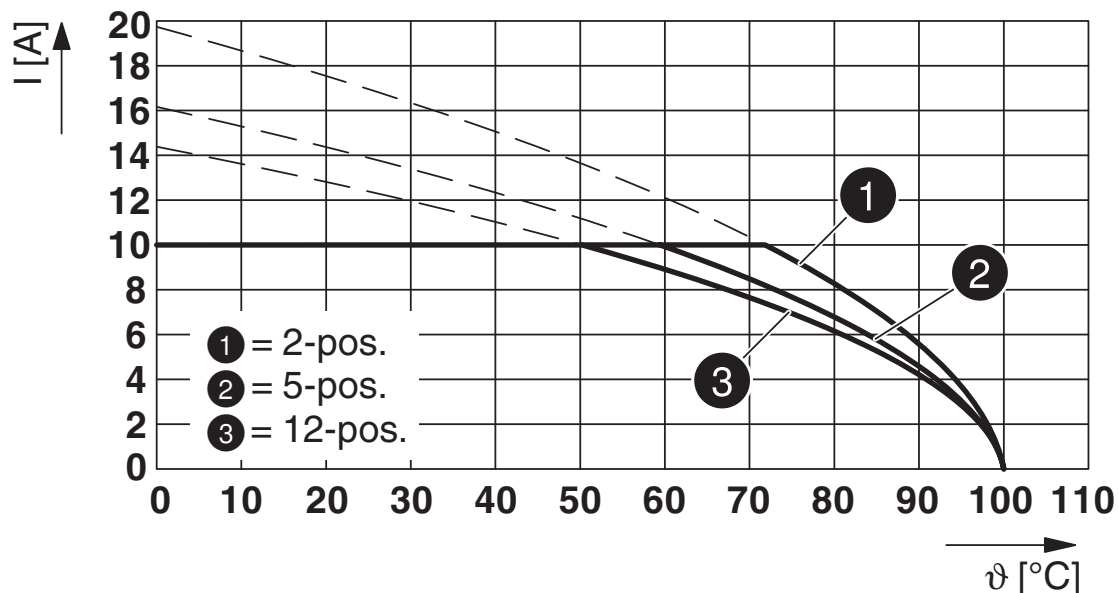

Type: FKCN 2,5/...-ST with MDSTBV 2,5/...-G

Diagram

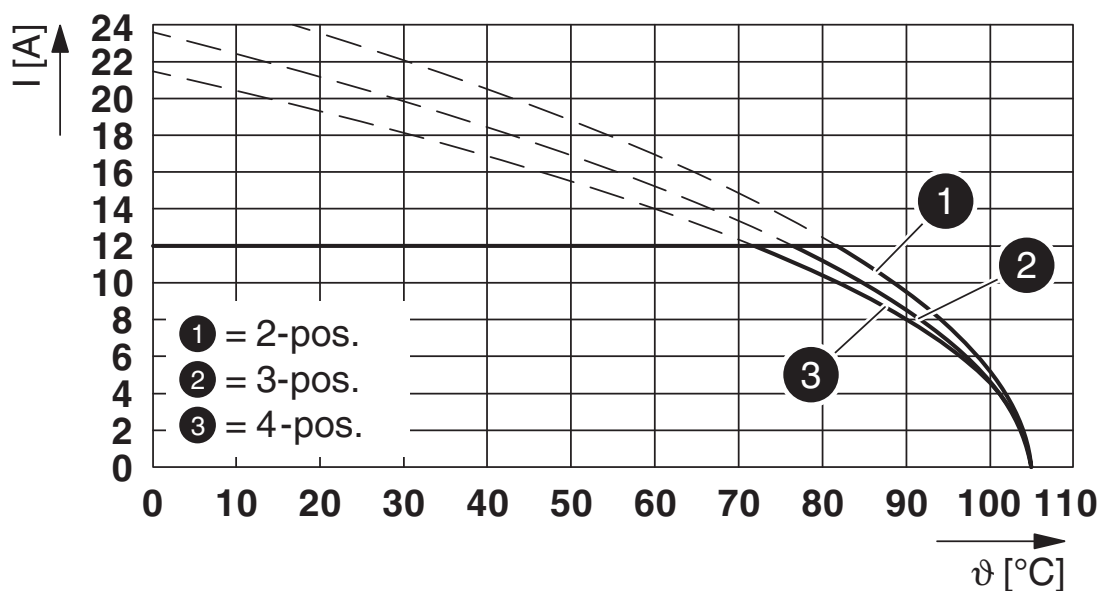

Type: FKCN 2,5/...-ST with MSTBO 2,5/...-G1L

FKCN 2,5/16-ST - PCB connector



1732878

<https://www.phoenixcontact.com/pc/products/1732878>

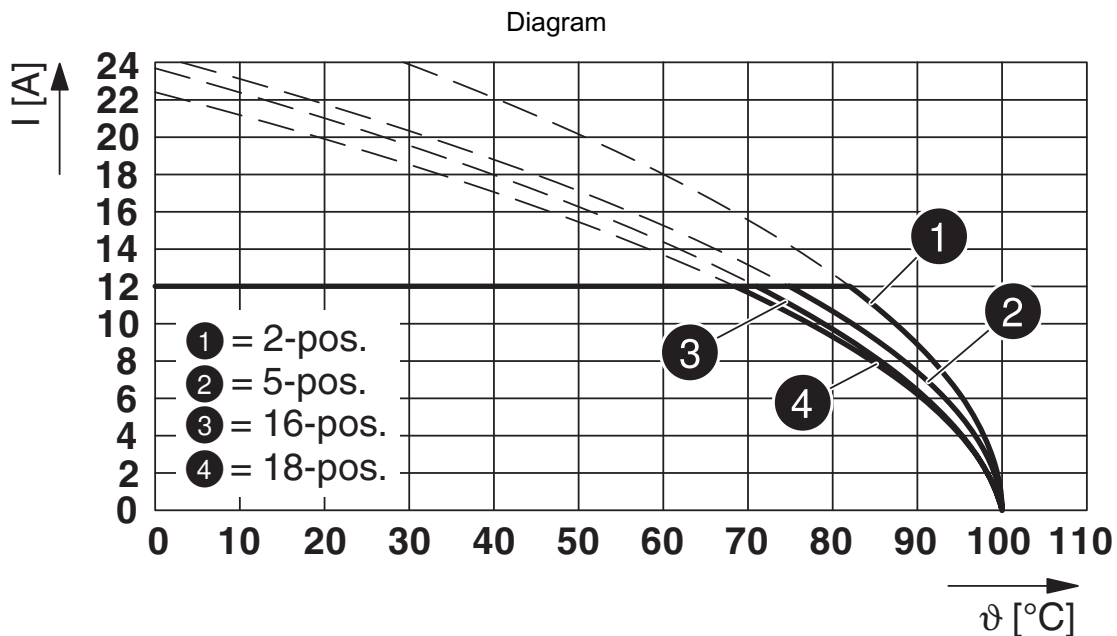

Type: FKCN 2,5/...-ST with MSTB 2,5/...-G

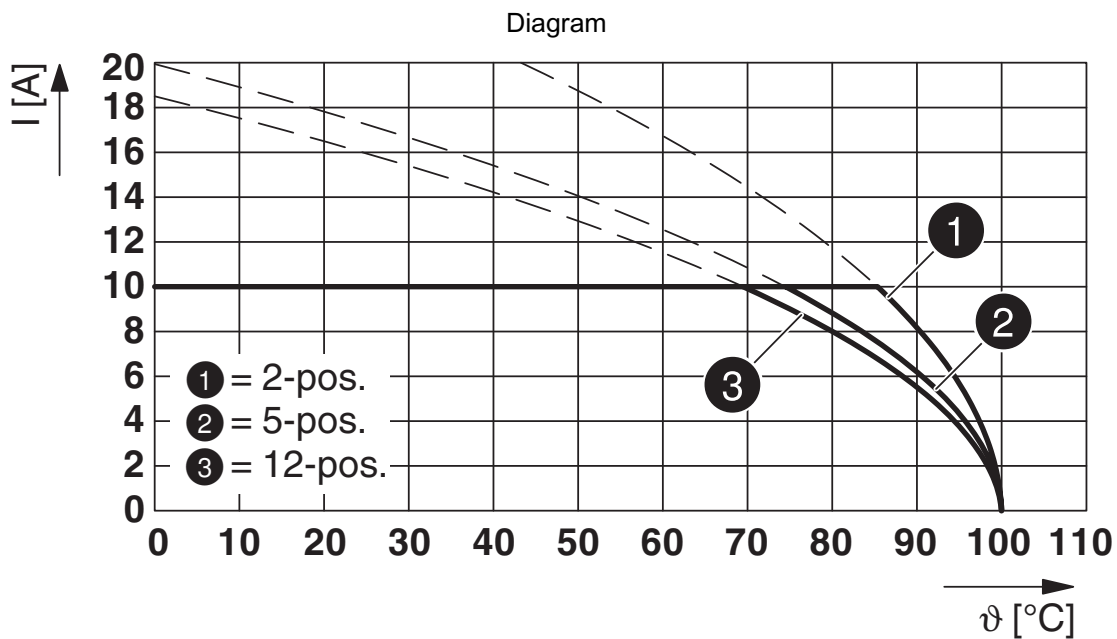

Type: FKCN 2,5/...-ST with MDSTB 2,5/...-G

FKCN 2,5/16-ST - PCB connector



1732878

<https://www.phoenixcontact.com/pc/products/1732878>

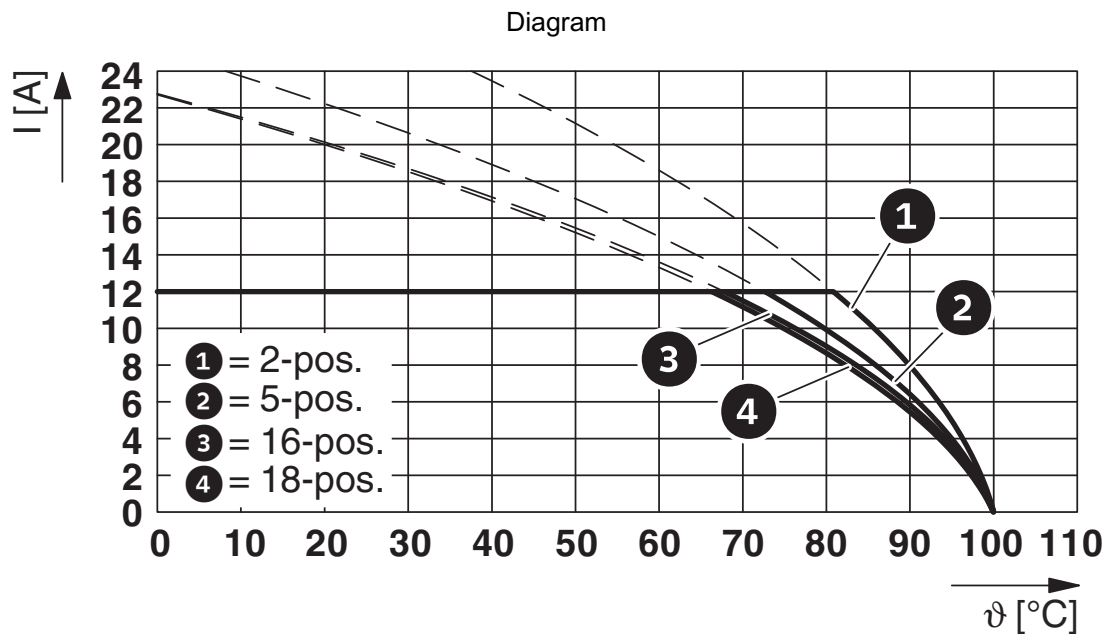

Type: FKCN 2,5/...-ST with MSTBW 2,5/...-G

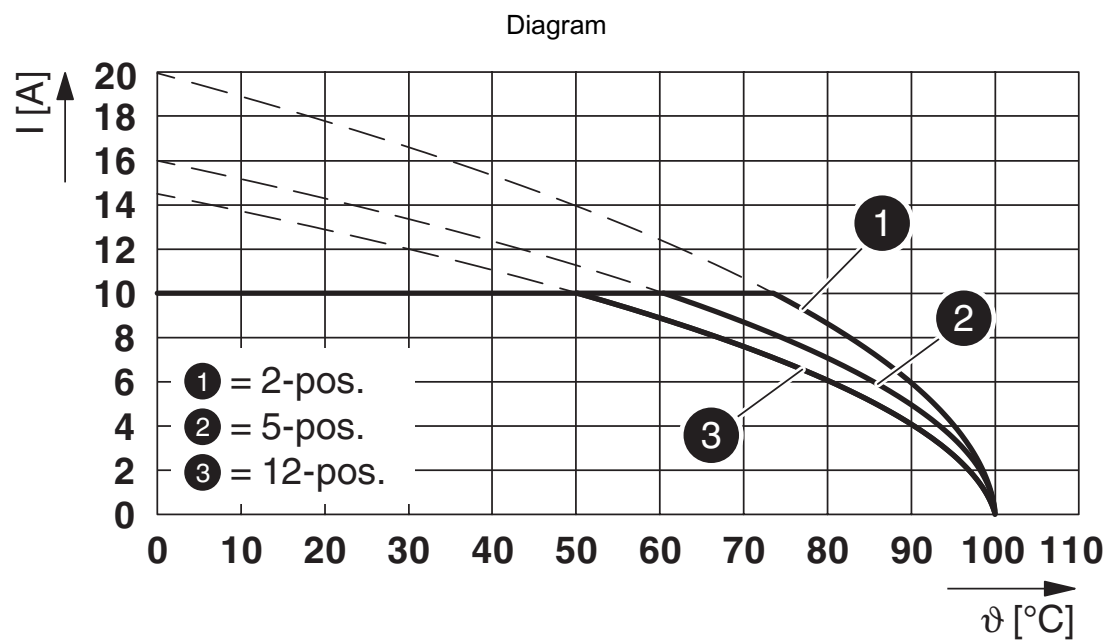

Type: FKCN 2,5/...-ST with MDSTBVA 2,5/...-G

FKCN 2,5/16-ST - PCB connector



1732878

<https://www.phoenixcontact.com/pc/products/1732878>

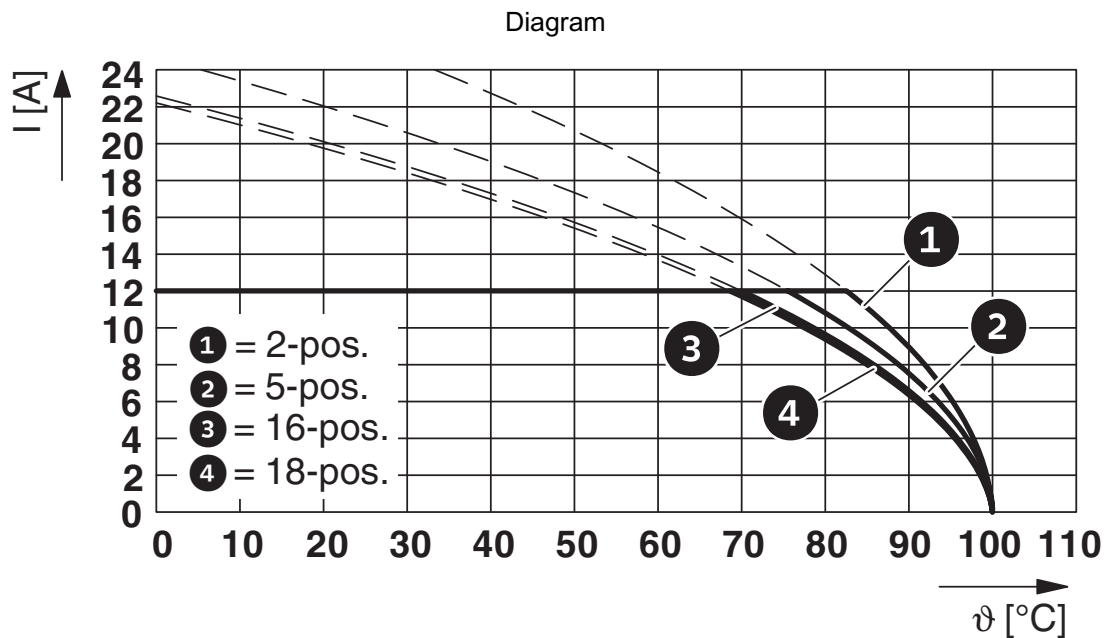

Type: FKCN 2,5/...-ST with SMSTB 2,5/...-G

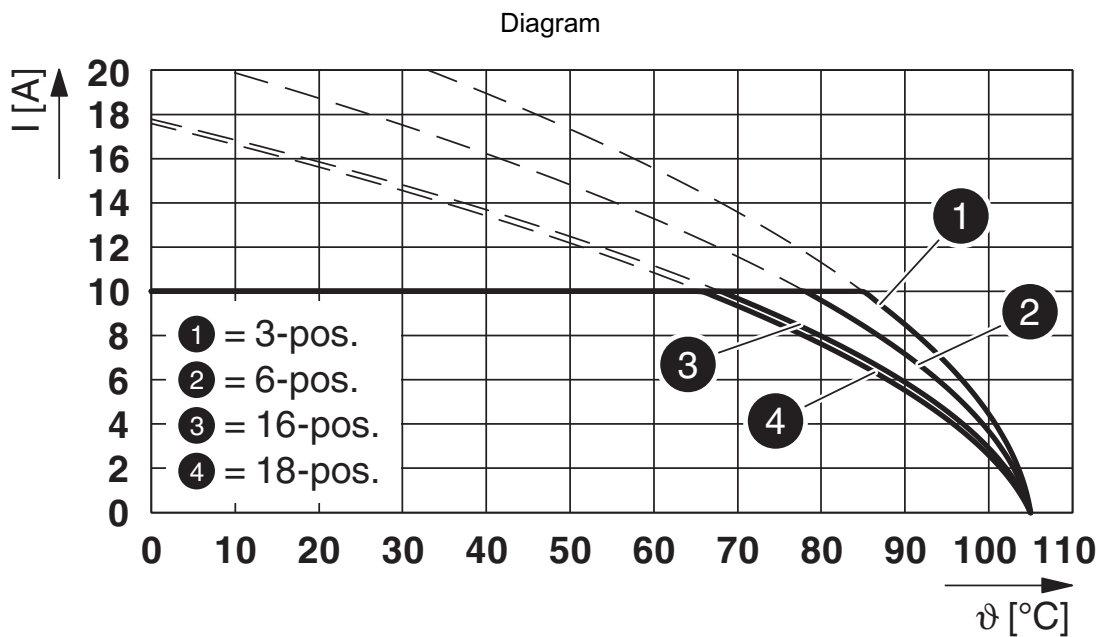

Type: FKCN 2,5/...-ST with MDSTB 2,5/...-G1

FKCN 2,5/16-ST - PCB connector



1732878

<https://www.phoenixcontact.com/pc/products/1732878>

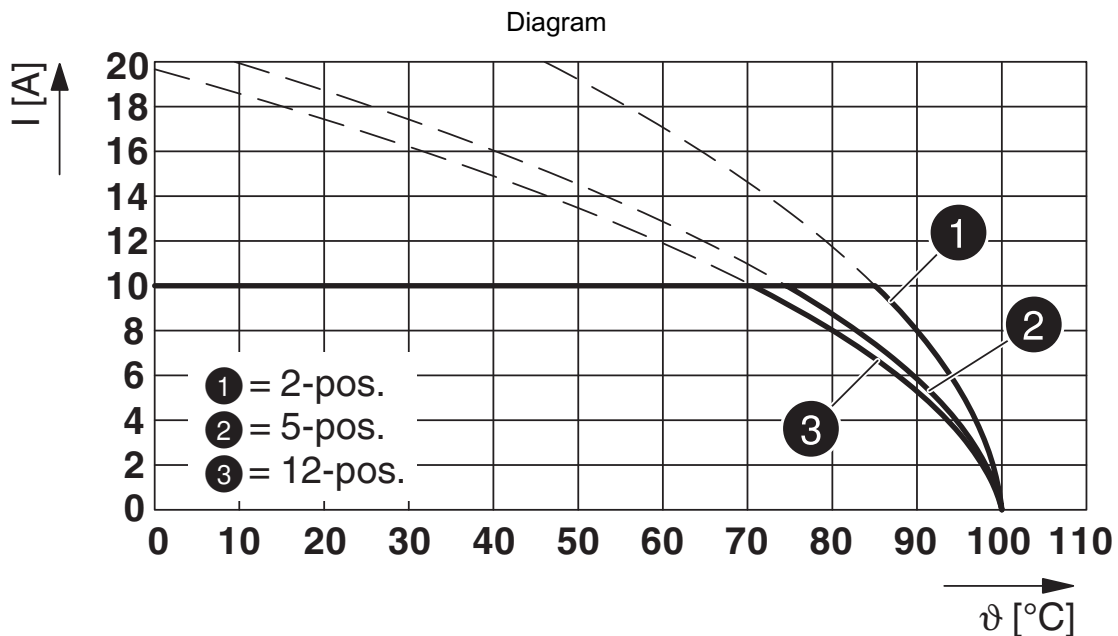

Type: FKCN 2,5/...-ST with MDSTBA 2,5/...-G

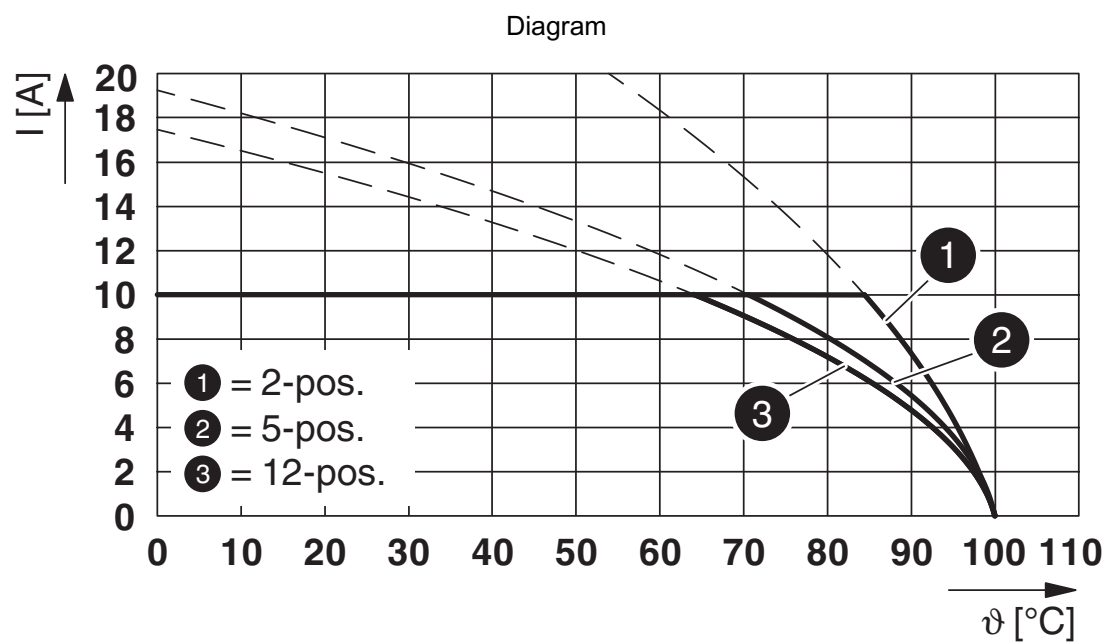

Type: FKCN 2,5/...-ST with MDSTBW 2,5/...-G

FKCN 2,5/16-ST - PCB connector



1732878

<https://www.phoenixcontact.com/pc/products/1732878>

Diagram

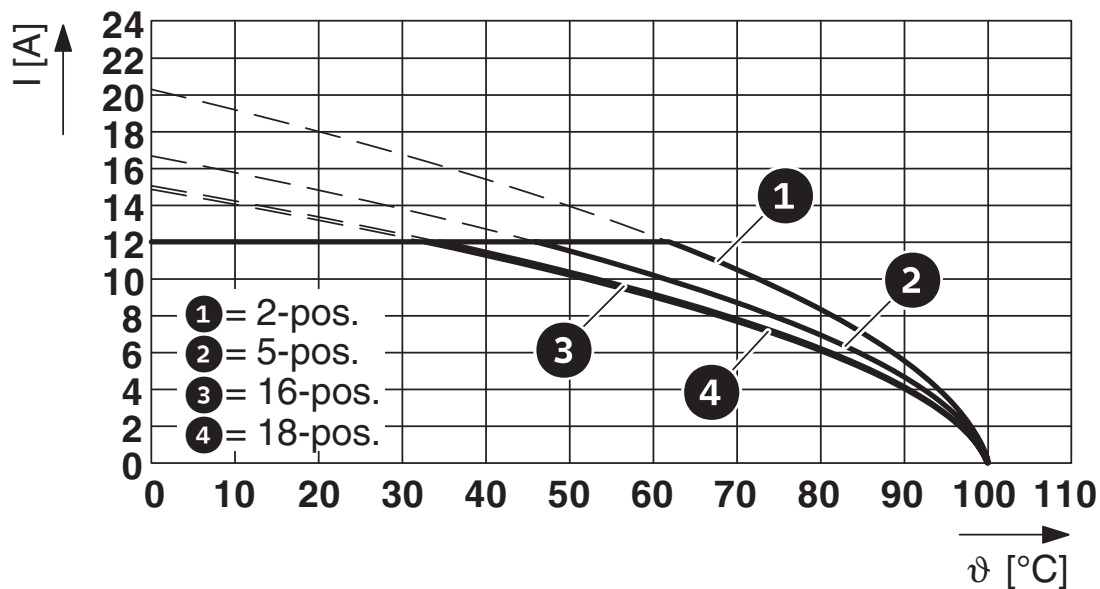

Type: FKCN 2,5/...-ST with MSTBV 2,5/...-G

Diagram

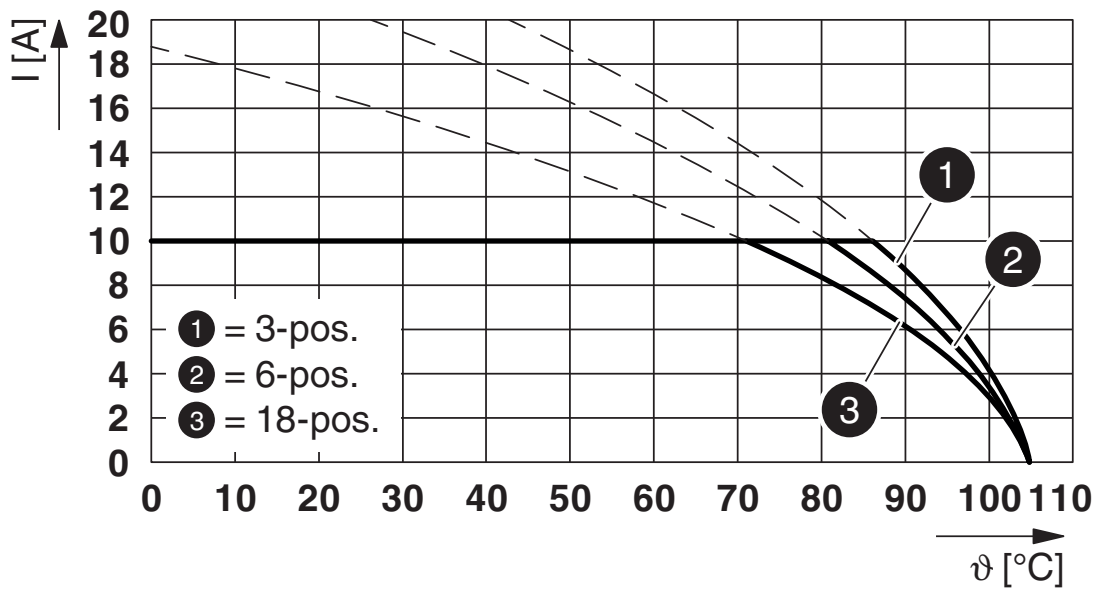

Type: FKCN 2,5/...-ST with MDSTBV 2,5/...-G1

FKCN 2,5/16-ST - PCB connector



1732878

<https://www.phoenixcontact.com/pc/products/1732878>

Diagram

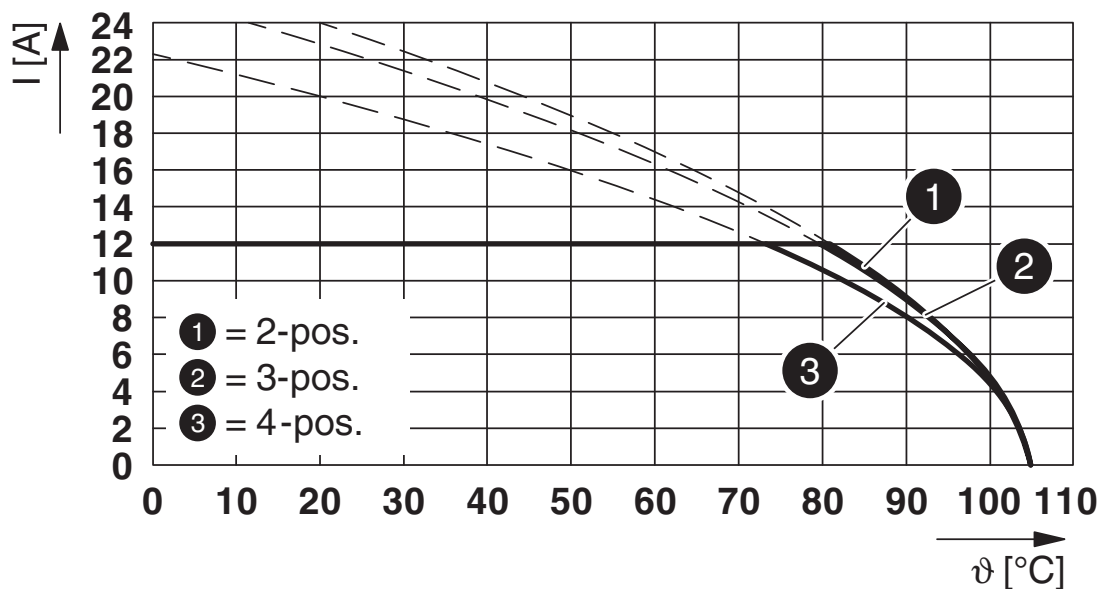

Type: FKCN 2,5/...-ST with MSTBO 2,5/...-G1R

Diagram

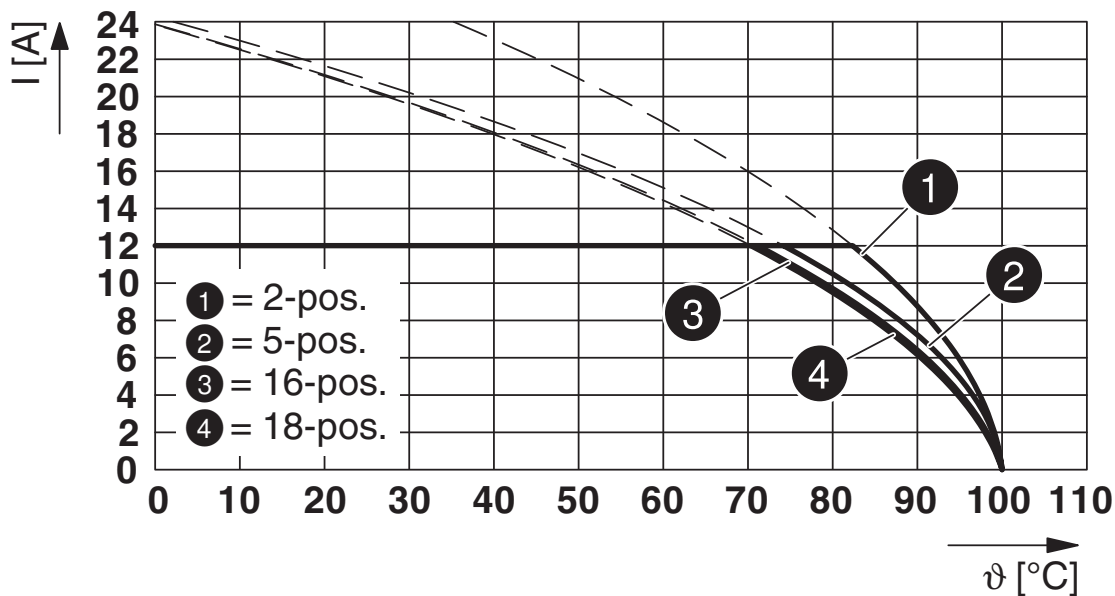

Type: FKCN 2,5/...-ST with SMSTBA 2,5/...-G

FKCN 2,5/16-ST - PCB connector



1732878

<https://www.phoenixcontact.com/pc/products/1732878>

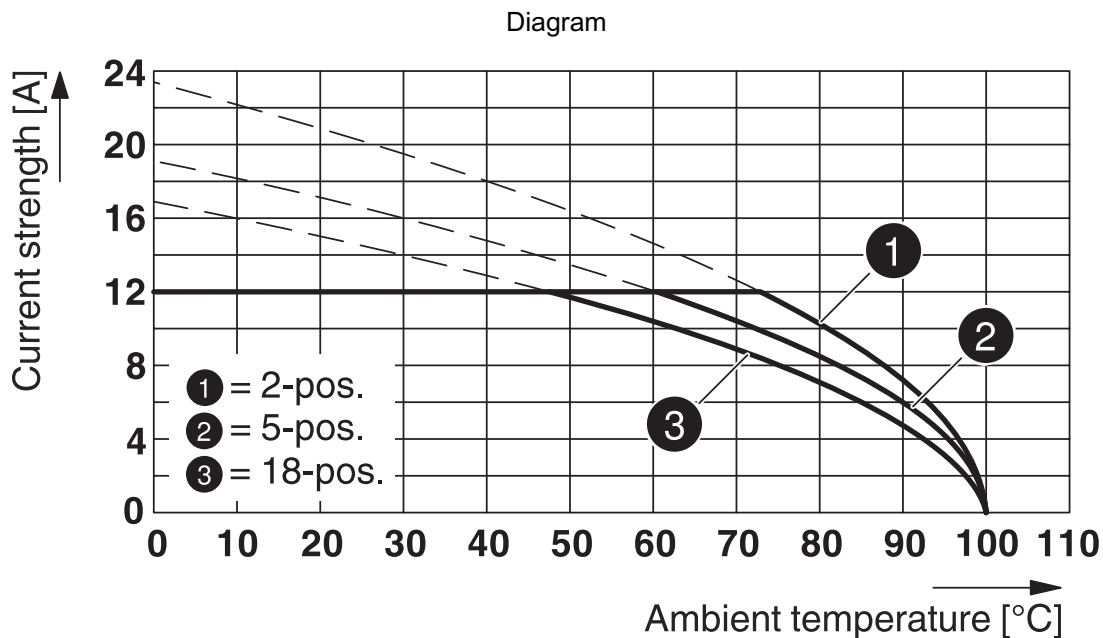

Type: FKCN 2,5/...-ST with CCDN 2,5/...-G1 P26 THR

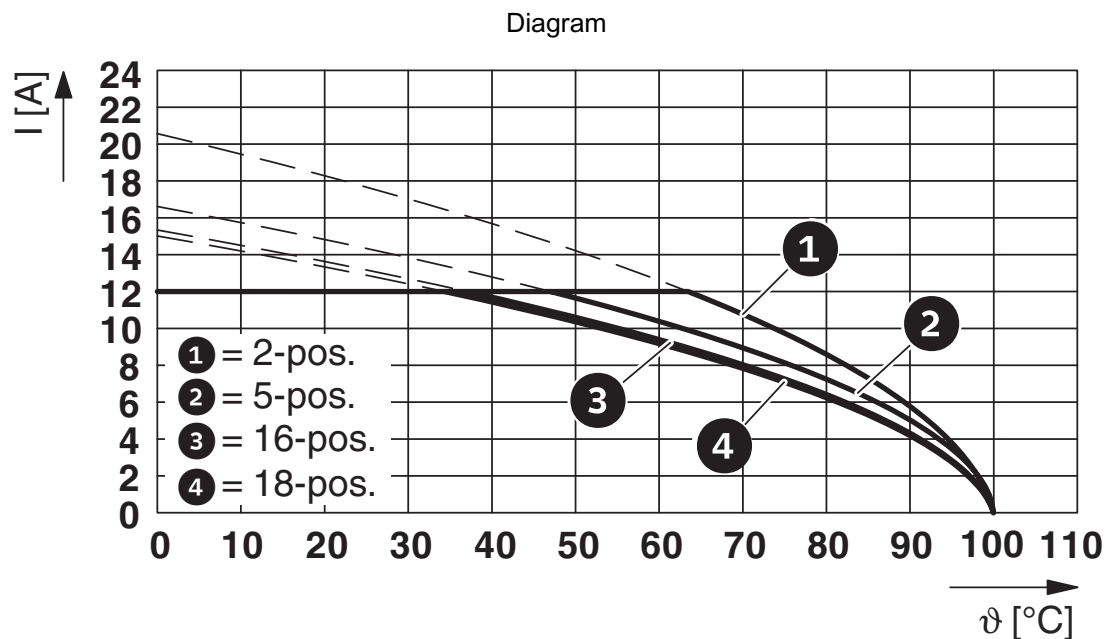

Type: FKCN 2,5/...-ST with MSTBVA 2,5/...-G

FKCN 2,5/16-ST - PCB connector



1732878

<https://www.phoenixcontact.com/pc/products/1732878>

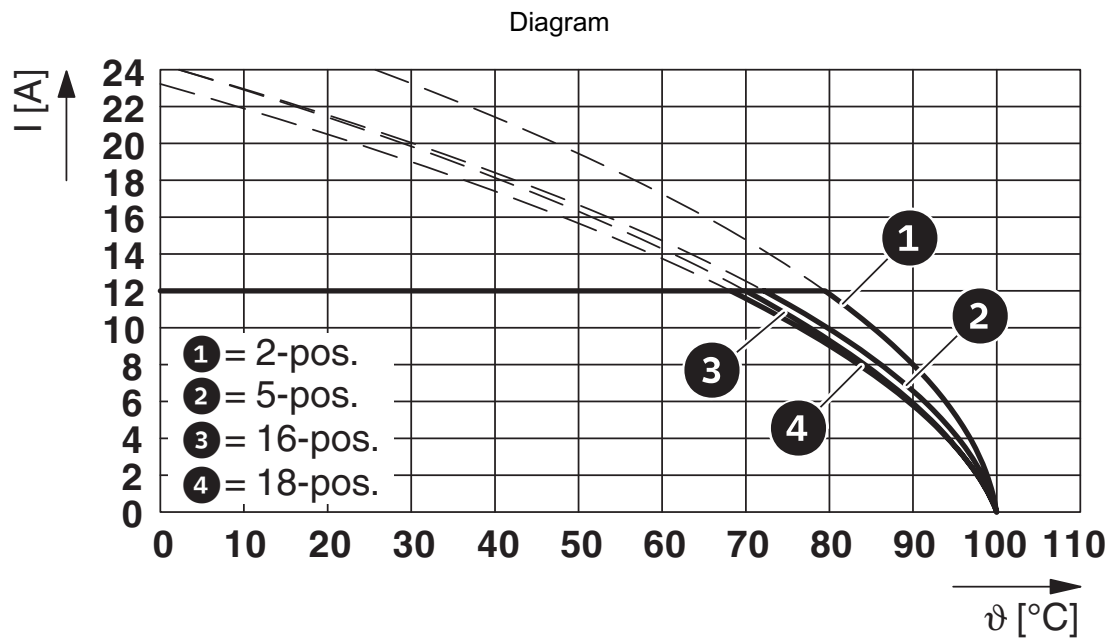

Type: FKCN 2,5/...-ST with MSTBA 2,5/...-G

FKCN 2,5/16-ST - PCB connector





1732878

<https://www.phoenixcontact.com/pc/products/1732878>

Approvals

To download certificates, visit the product detail page: <https://www.phoenixcontact.com/pc/products/1732878>

 IECEE CB Scheme Approval ID: DE1-58427				
	Nominal Voltage U_N	Nominal Current I_N	Cross Section AWG	Cross Section mm^2
	400 V	12 A	-	0.2 - 2.5

 EAC Approval ID: B.01687				
--	--	--	--	--

 VDE Gutachten mit Fertigungsüberwachung Approval ID: 40041908				
	Nominal Voltage U_N	Nominal Current I_N	Cross Section AWG	Cross Section mm^2
	400 V	12 A	-	0.2 - 2.5

FKCN 2,5/16-ST - PCB connector



1732878

<https://www.phoenixcontact.com/pc/products/1732878>

Classifications

ECLASS

ECLASS-11.0	27460202
ECLASS-12.0	27460202
ECLASS-13.0	27460202

ETIM

ETIM 8.0	EC002638
----------	----------

UNSPSC

UNSPSC 21.0	39121400
-------------	----------

FKCN 2,5/16-ST - PCB connector



1732878

<https://www.phoenixcontact.com/pc/products/1732878>

Environmental Product Compliance

China RoHS	Environmentally friendly use period: unlimited = EFUP-e
	No hazardous substances above threshold values

FKCN 2,5/16-ST - PCB connector

1732878

<https://www.phoenixcontact.com/pc/products/1732878>

Accessories

CP-MSTB - Coding profile

1734634

<https://www.phoenixcontact.com/pc/products/1734634>

Coding profile, is inserted into the slot on the plug or inverted header, red insulating material



CRIMPFOX 6 - Crimping pliers

1212034

<https://www.phoenixcontact.com/pc/products/1212034>

Crimping pliers, for ferrules without insulating collar according to DIN 46228 Part 1 and ferrules with insulating collar according to DIN 46228 Part 4, 0.25 mm² ... 6.0 mm², lateral entry, trapezoidal crimp



FKCN 2,5/16-ST - PCB connector

1732878

<https://www.phoenixcontact.com/pc/products/1732878>



AI 0,5 -10 WH - Ferrule

3201275

<https://www.phoenixcontact.com/pc/products/3201275>



Ferrule, sleeve length: 10 mm, length: 16 mm, color: white

AI 0,75-10 GY - Ferrule

3201288

<https://www.phoenixcontact.com/pc/products/3201288>



Ferrule, sleeve length: 10 mm, length: 16 mm, color: gray

FKCN 2,5/16-ST - PCB connector

1732878

<https://www.phoenixcontact.com/pc/products/1732878>

AI 1 -10 RD - Ferrule

3200182

<https://www.phoenixcontact.com/pc/products/3200182>



Ferrule, sleeve length: 10 mm, length: 16 mm, color: red

AI 1,5 -10 BK - Ferrule

3200195

<https://www.phoenixcontact.com/pc/products/3200195>



Ferrule, sleeve length: 10 mm, length: 16 mm, color: black

FKCN 2,5/16-ST - PCB connector

1732878

<https://www.phoenixcontact.com/pc/products/1732878>

A 0,5 -10 - Ferrule

3202494

<https://www.phoenixcontact.com/pc/products/3202494>



Ferrule, length: 10 mm, color: silver

A 0,75-10 - Ferrule

3200234

<https://www.phoenixcontact.com/pc/products/3200234>



Ferrule, length: 10 mm, color: silver

FKCN 2,5/16-ST - PCB connector

1732878

<https://www.phoenixcontact.com/pc/products/1732878>

A 1 -10 - Ferrule

3200250

<https://www.phoenixcontact.com/pc/products/3200250>



Ferrule, length: 10 mm, color: silver

A 1,5 -10 - Ferrule

3200276

<https://www.phoenixcontact.com/pc/products/3200276>



Ferrule, length: 10 mm, color: silver

FKCN 2,5/16-ST - PCB connector

1732878

<https://www.phoenixcontact.com/pc/products/1732878>



SZS 0,6X3,5 - Screwdriver

1205053

<https://www.phoenixcontact.com/pc/products/1205053>



Actuation tool, for ST terminal blocks, insulated, also suitable for use as a bladed screwdriver, size: 0.6 x 3.5 x 100 mm, 2-component grip, with non-slip grip

CCDN 2,5/16-G1 P26 THR - PCB header

1734410

<https://www.phoenixcontact.com/pc/products/1734410>



PCB headers, nominal cross section: 2.5 mm², color: black, nominal current: 12 A, rated voltage (III/2): 320 V, contact surface: Tin, type of contact: Pin, number of potentials: 32, number of rows: 2, number of positions: 16, number of connections: 32, product range: CCDN 2,5/..-G1-THR, pitch: 5 mm, mounting: THR soldering, pin layout: Linear pinning, solder pin [P]: 2.6 mm, number of solder pins per potential: 1, plug-in system: COMBICON MSTB 2,5, Pin connector pattern alignment: Standard, locking: without, mounting: without, type of packaging: packed in cardboard

FKCN 2,5/16-ST - PCB connector

1732878

<https://www.phoenixcontact.com/pc/products/1732878>



MSTBW 2,5/16-G - PCB header

1735976

<https://www.phoenixcontact.com/pc/products/1735976>



PCB headers, nominal cross section: 2.5 mm², color: green, nominal current: 12 A, rated voltage (III/2): 320 V, contact surface: Tin, type of contact: Pin, number of potentials: 16, number of rows: 1, number of positions: 16, number of connections: 16, product range: MSTBW 2,5/..-G, pitch: 5 mm, mounting: Wave soldering, pin layout: Linear pinning, solder pin [P]: 3.5 mm, number of solder pins per potential: 1, plug-in system: COMBICON MSTB 2,5, Pin connector pattern alignment: Standard, locking: without, mounting: without, type of packaging: packed in cardboard

Phoenix Contact 2023 © - all rights reserved

<https://www.phoenixcontact.com>

PHOENIX CONTACT GmbH & Co. KG

Flachsmarktstraße 8

D-32825 Blomberg

+49 (0) 5235-3 00

info@phoenixcontact.com