

PLEASE CHECK WWW.MOLEX.COM FOR LATEST PART INFORMATION

Part Number: [1731120827](#)
Status: **Active**
Overview: [FCT D-Sub Connectors](#)
Description: FCT Coaxial Contact, 3 Pins, Male, Straight, PCB Through Hole, 50 Ohms, 0.20µm Gold Plating

Documents:

[Brochure \(PDF\)](#) [RoHS Certificate of Compliance \(PDF\)](#)

General

Product Family	D-Sub Products
Series	173112
Contact Type	Coaxial
Overview	FCT D-Sub Connectors
Product Category	Contacts
Product Name	FCT Products
Type	Mixed Layout
UPC	191128907385

Physical

Durability (mating cycles max)	200
Gender	Male
Material - Contact	Copper Alloy
Net Weight	3.600/g
Orientation	Straight
Packaging Type	Adhesive Tape on Reel
Plating - Contact	Gold over Nickel
Plating min - Mating	0.200µm
Plating min - Termination	0.200µm
Temperature Range - Operating	-55° to +135°C
Termination Style	Through Hole

Electrical

Current - Maximum per Contact	2.0A
Impedance	50Ω

Material Info

Engineering Number	FME010P101
--------------------	------------

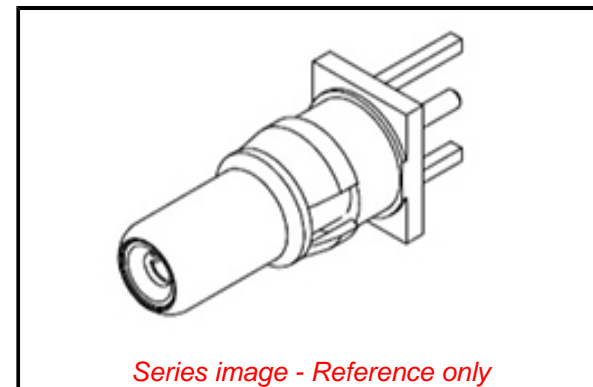

Series image - Reference only

EU ELV

Not Relevant

EU RoHS

Compliant with Exemption 6(c)

REACH SVHC

Not Reviewed

Halogen-Free

Status

Not Reviewed

For more information, please visit [Contact US](#)

China ROHS

ELV

RoHS Phthalates

China RoHS

50 Image

Not Relevant

Not Contained

Search Parts in this Series

[173112 Series](#)

Use With

FCT Mixed Layout Connectors