

PLEASE CHECK WWW.MOLEX.COM FOR LATEST PART INFORMATION

Part Number: [1731120171](#)
Status: **Active**
Overview: [FCT D-Sub Connectors](#)
Description: FCT Coaxial Contact, Female, Straight, Solder Cable Termination, 75 Ohms, 1.30µm Gold Plating, Short Version, for RG-179BU or RG-187AU Cable

Documents:

[Brochure \(PDF\)](#) [RoHS Certificate of Compliance \(PDF\)](#)

General

Product Family	D-Sub Products
Series	173112
Contact Type	Coaxial
Overview	FCT D-Sub Connectors
Product Category	Contacts
Product Name	FCT Products
Type	Mixed Layout
UPC	889056489263
Wire/Cable Type	RG-179BU, RG-187AU

Physical

Durability (mating cycles max)	200
Gender	Female
Material - Contact	Copper Alloy
Net Weight	1.100/g
Orientation	Straight
Packaging Type	Bag
Plating - Contact	Gold over Nickel
Plating min - Mating	0.800µm
Plating min - Termination	1.300µm
Temperature Range - Operating	-55° to +135°C
Termination Style	Solder

Electrical

Current - Maximum per Contact	2.0A
Impedance	75Ω

Material Info

Engineering Number	FMX002S102
--------------------	------------

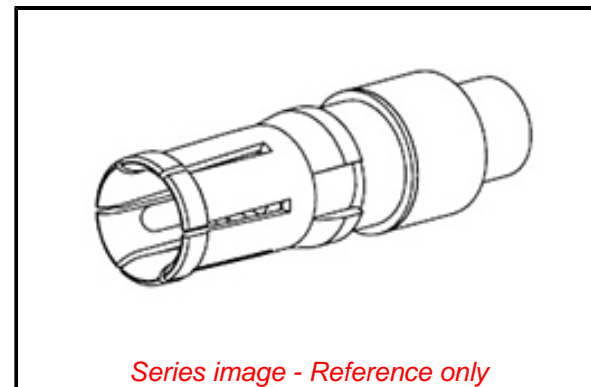

Series image - Reference only

EU ELV

Not Relevant

EU RoHS

Compliant with Exemption 6(c)

REACH SVHC

Not Reviewed

Halogen-Free

Status

Not Reviewed

For more information, please visit [Contact US](#)

China ROHS

50 Image

ELV

Not Relevant

RoHS Phthalates

Not Contained

Search Parts in this Series

[173112 Series](#)

Use With

FCT Mixed Layout Connectors