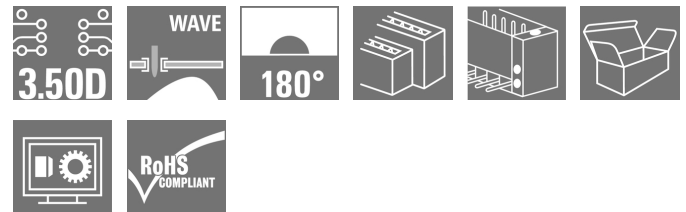

**OMNIMATE Signal - series B2L/S2L 3.50 - 2-row
S2L 3.50/20/180F 3.5SN OR BX**

Weidmüller Interface GmbH & Co. KG
Klingenbergstraße 16
D-32758 Detmold
Germany
Fon: +49 5231 14-0
Fax: +49 5231 14-292083
www.weidmueller.com

Product image

Similar to illustration

Straight, double-row pin header available in closed-sided or flange version (open-sided pin headers on request). The male headers with a pin length of 3.5mm are designed for wave soldering and are packed in a box. They can be screwed on to the PCB. The male headers provide space for labelling and can be coded.

General ordering data

Type	S2L 3.50/20/180F 3.5SN OR BX
Order No.	1729500000
Version	PCB plug-in connector, male header, Flange, THT solder connection, 3.50 mm, No. of poles: 20, 180°, Solder pin length (l): 3.5 mm, tinned, Orange, Box
GTIN (EAN)	4032248036929
Qty.	42 pc(s).
Product data	IEC: 250 V / 10 A UL: 150 V / 10 A
Packaging	Box

**OMNIMATE Signal - series B2L/S2L 3.50 - 2-row
S2L 3.50/20/180F 3.5SN OR BX**

Weidmüller Interface GmbH & Co. KG
Klingenbergstraße 16
D-32758 Detmold
Germany
Fon: +49 5231 14-0
Fax: +49 5231 14-292083
www.weidmueller.com

Technical data**Dimensions and weights**

Width	42 mm	Width (inches)	1.654 inch
Height	17.7 mm	Height (inches)	0.697 inch
Height of lowest version	14.2 mm	Depth	10.5 mm
Depth (inches)	0.413 inch	Net weight	5.63 g

System specifications

Product family	OMNIMATE Signal - series B2L/S2L 3.50 - 2-row	Type of connection	Board connection
Mounting onto the PCB	THT solder connection	Pitch in mm (P)	3.5 mm
Pitch in inches (P)	0.138 inch	Outgoing elbow	180°
No. of poles	20	Number of solder pins per pole	1
Solder pin length (l)	3.5 mm	Tolerance of solder pin position	± 0.20 mm
Solder pin dimensions	d = 1.0 mm, Octagonal	Solder eyelet hole diameter (D)	1.3 mm
Solder eyelet hole diameter tolerance (D)+ 0,1 mm		L1 in mm	31.5 mm
L1 in inches	1.24 inch	Number of rows	1
Pin series quantity	2	Touch-safe protection acc. to DIN VDE 57 106	Safe from back-of-hand touch
Touch-safe protection acc. to DIN VDE 0470	IP 10	Can be coded	Yes
Plugging cycles	25	Plugging force/pole, max.	5 N
Pulling force/pole, max.	4 N		

Material data

Insulating material	PBT	Colour	Orange
Colour chart (similar)	RAL 2000	Insulating material group	IIIa
CTI	≥ 200	Insulation resistance	≥ 10 ⁸ Ω
UL 94 flammability rating	V-0	Contact material	Copper alloy
Contact surface	tinned	Layer structure of solder connection	2-3 μm Ni / 5-7 μm Sn glossy
Storage temperature, min.	-25 °C	Storage temperature, max.	55 °C
Max. relative humidity during storage	80 %	Operating temperature, min.	-50 °C
Operating temperature, max.	100 °C	Temperature range, installation, min.	-30 °C
Temperature range, installation, max.	100 °C		

Rated data acc. to IEC

tested acc. to standard	IEC 60664-1, IEC 61984	Rated current, min. no. of poles (Tu=20°C)	10 A
Rated current, max. no. of poles (Tu=20°C)	10 A	Rated current, min. no. of poles (Tu=40°C)	9 A
Rated current, max. no. of poles (Tu=40°C)	8.5 A	Rated voltage for surge voltage class / pollution degree II/2	250 V
Rated voltage for surge voltage class / pollution degree III/2	125 V	Rated voltage for surge voltage class / pollution degree III/3	80 V
Rated impulse voltage for surge voltage class/ pollution degree II/2	2.5 kV	Rated impulse voltage for surge voltage class/ pollution degree III/2	2.5 kV
Rated impulse voltage for surge voltage class/ contamination degree III/3	2.5 kV	Short-time withstand current resistance	3 x 1s with 77 A

Data sheet

**OMNIMATE Signal - series B2L/S2L 3.50 - 2-row
S2L 3.50/20/180F 3.5SN OR BX**

Weidmüller Interface GmbH & Co. KG
Klingenbergstraße 16
D-32758 Detmold
Germany
Fon: +49 5231 14-0
Fax: +49 5231 14-292083
www.weidmueller.com

Technical data

Rated data acc. to CSA

Institute (CSA)		Certificate No. (CSA)	200039-1488444
Rated voltage (Use group B / CSA)	150 V	Rated current (Use group B / CSA)	5 A
Reference to approval values	Specifications are maximum values, details - see approval certificate.		

Rated data acc. to UL 1059

Institute (UR)		Certificate No. (UR)	E60693
Rated voltage (Use group B / UL 1059)	150 V	Rated voltage (Use group C / UL 1059)	50 V
Rated current (Use group B / UL 1059)	10 A	Rated current (Use group C / UL 1059)	10 A
Reference to approval values	Specifications are maximum values, details - see approval certificate.		

Packaging

Packaging	Box	VPE length	30 mm
VPE width	135 mm	VPE height	350 mm

Classifications

ETIM 4.0	EC002637	ETIM 5.0	EC002637
ETIM 6.0	EC002637	UNSPSC	30-21-18-10
eClass 5.1	27-26-07-01	eClass 6.2	27-26-07-04
eClass 7.1	27-44-04-02	eClass 8.1	27-44-04-02
eClass 9.0	27-44-04-02	eClass 9.1	27-44-04-02

Notes

Notes	<ul style="list-style-type: none"> • Additional colours on request • Gold-plated contact surfaces on request • Spacing between rows: see hole layout • Rated current related to rated cross-section & min. No. of poles. • P on drawing = pitch • Rated data refer only to the component itself. Clearance and creepage distances to other components are to be designed in accordance with the relevant application standards. • For additional mechanical support for male connectors with screw flange (...F), we recommend an additional cable gland with fastening screws (sheet metal screw ISO 1481-ST 2.2x4.5 C or ISO 7049-ST 2.2x4.5 C - see Accessories). Cable gland only permitted before soldering.
-------	--

IPC conformity	Conformity: The products are developed, manufactured and delivered according international recognized standards and norms and comply with the assured properties in the data sheet resp. fulfill decorative properties in accordance with IPC-A-610 "Class 2". Further claims on the products can be evaluated on request.
----------------	--

Creation date January 16, 2019 1:25:46 PM CET

Data sheet

**OMNIMATE Signal - series B2L/S2L 3.50 - 2-row
S2L 3.50/20/180F 3.5SN OR BX**

Weidmüller Interface GmbH & Co. KG
Klingenbergstraße 16
D-32758 Detmold
Germany
Fon: +49 5231 14-0
Fax: +49 5231 14-292083
www.weidmueller.com

Technical data

Approvals

Approvals



ROHS

Conform

Downloads

Approval/Certificate/Document of Conformity

[Declaration of the Manufacturer](#)

Brochure/Catalogue

- [FL DRIVES EN](#)
- [MB DEVICE MANUF. EN](#)
- [FL DRIVES DE](#)
- [CAT 2 PORTFOLIOGUIDE EN](#)
- [FL BUILDING SAFETY EN](#)
- [FL APPL LED LIGHTING EN](#)
- [FLIndustr.CONTROLS EN](#)
- [FL MACHINE SAFETY EN](#)
- [FL HEATING ELECTR EN](#)
- [FL APPL INVERTER EN](#)
- [FL_BASE_STATION_EN](#)
- [FL ELEVATOR EN](#)
- [FL POWER SUPPLY EN](#)
- [FL 72H SAMPLE SER EN](#)
- [PO OMNIMATE EN](#)

Engineering Data

[EPLAN_WSCAD](#)

Engineering Data

[S2L-SMT.zip](#)
[STEP](#)

Data sheet

**OMNIMATE Signal - series B2L/S2L 3.50 - 2-row
S2L 3.50/20/180F 3.5SN OR BX**

Weidmüller Interface GmbH & Co. KG
 Klingenbergstraße 16
 D-32758 Detmold
 Germany
 Fon: +49 5231 14-0
 Fax: +49 5231 14-292083
 www.weidmueller.com

Drawings

Dimensional drawing

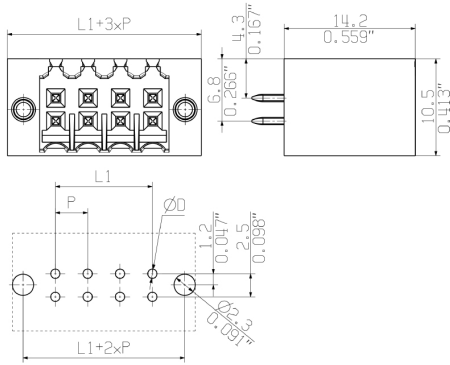

The reproduction, distribution and utilization of this document as well as the communication of its contents to others without explicit authorization is prohibited. Offenders will be held liable for the payment of damages. Weidmüller exclusively reserves the right to file for patents, utility models or designs.

© Weidmüller Interface GmbH & Co. KG

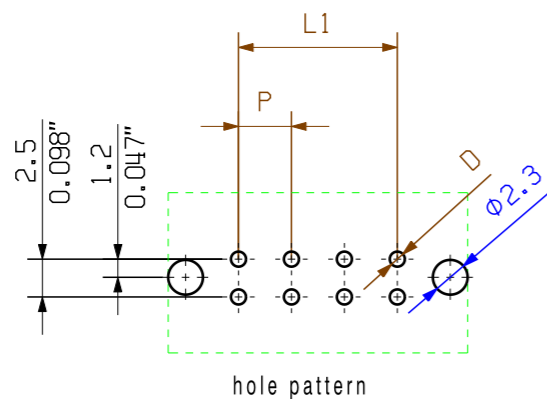
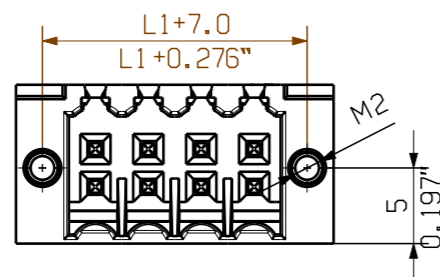
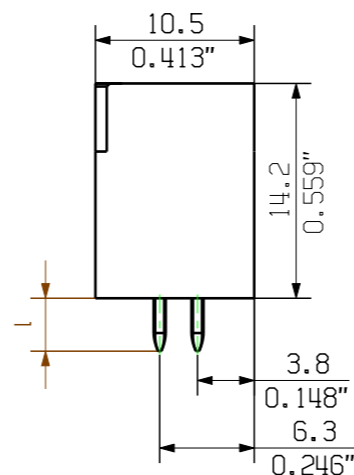
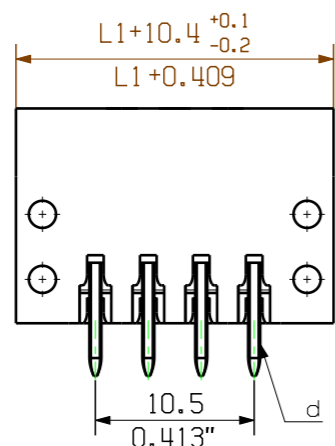

hole pattern

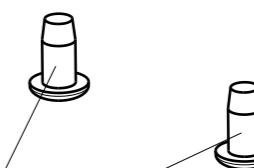
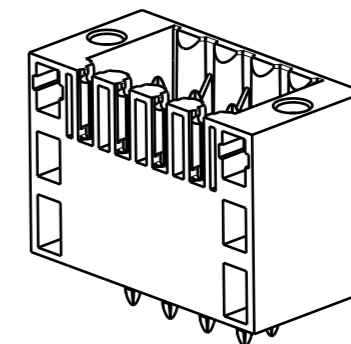

optional fixing screw
order no.: 161074 0000

P = 3.50 Raster Pitch
D = Ø1,3^{+0.1}
Ø0.051^{+0.1}
d = 1mm oktogonal
0.039" octogonal

shown S2L 3.50/././180F

pin length l	tolerance
3,5	0,2 -0,2
2,6	0,2 -0,2

46	77.0	+/-0.2
44	73.5	
42	70.0	
40	66.5	
38	63.0	
36	59.5	
34	56.0	+/-0.15
32	52.5	
30	49.0	
28	45.5	
26	42.0	
24	38.5	
22	35.0	+/-0.1
20	31.5	
18	28.0	
16	24.5	
14	21.0	
12	17.5	
10	14.0	
8	10.5	
6	7.0	
4	3.5	
n Polzahl/ no of poles	L1	Toleranz/ tolerance L1

For the mounting of PCBs, it should be noted that the rated data given in the catalogue relates only to the connection elements. The necessary creepage and clearance paths must be observed in connection with the respective applicant in accordance with VDE 0110. The current-carrying capacity and pitch tolerance is to be determined according to DIN IEC 326 part 3 very fine.

Weidmüller connectors are tested to the DIN VDE 0627 standard, and are valid for its field of application. Provided that the connectors are used to the intended purpose, all requirements with respect to the occurring of electrical, mechanical, thermic and corrosive stress will be satisfied.

General tolerance: DIN ISO 2768-mK		98746/5 29.11.17 HELIS_MA 01		Cat.no.: .									
		Modification											
		<table border="1"> <thead> <tr> <th>Date</th> <th>Name</th> </tr> </thead> <tbody> <tr> <td>Drawn 28.11.2008</td> <td>HELIS_MA</td> </tr> <tr> <td>Responsible</td> <td>AMANN_A</td> </tr> <tr> <td>Checked 04.12.2017</td> <td>HELIS_MA</td> </tr> <tr> <td>Approved</td> <td>LANG_T</td> </tr> </tbody> </table>		Date	Name	Drawn 28.11.2008	HELIS_MA	Responsible	AMANN_A	Checked 04.12.2017	HELIS_MA	Approved	LANG_T
Date	Name												
Drawn 28.11.2008	HELIS_MA												
Responsible	AMANN_A												
Checked 04.12.2017	HELIS_MA												
Approved	LANG_T												
Scale: 5/1		Supersedes: .		S2L 3.50/././... STIFTLISTE MALE HEADER Product file: S2L 3.50 7110									

Recommended wave soldering profiles

Weidmüller Interface GmbH & Co. KG
 Klängenbergstraße 16
 D-32758 Detmold
 Germany
 Fon: +49 5231 14-0
 Fax: +49 5231 14-292083
 www.weidmueller.com

Single Wave:



Double Wave:



Wave soldering profiles

Wired connection elements should be processed in accordance with the DIN EN 61760-1 standard. We have included two recommendations for practical wave soldering profiles, with which Weidmüller PCB terminals and connectors are qualified.

When choosing a suitable profile for your application, the following factors also need to be considered:

- PCB thickness
- Proportion of Cu in the layers
- Single/double-sided assembly
- Product range
- Heating and cooling rates

The single and double wave profiles each indicate the recommended operating range, including the maximum soldering temperature of 260°C. In practice, the maximum soldering temperature is quite often well below the above maximum profile.