

DESCRIPTION: **FEMALE SOLDER CUP/MACHINED-PREMIUM**

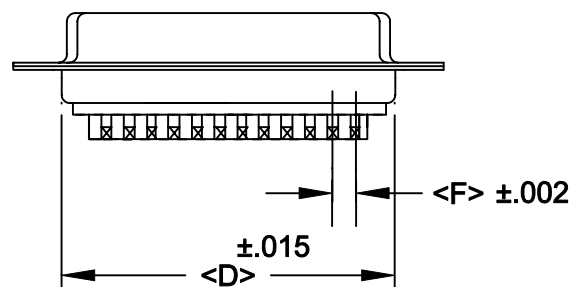
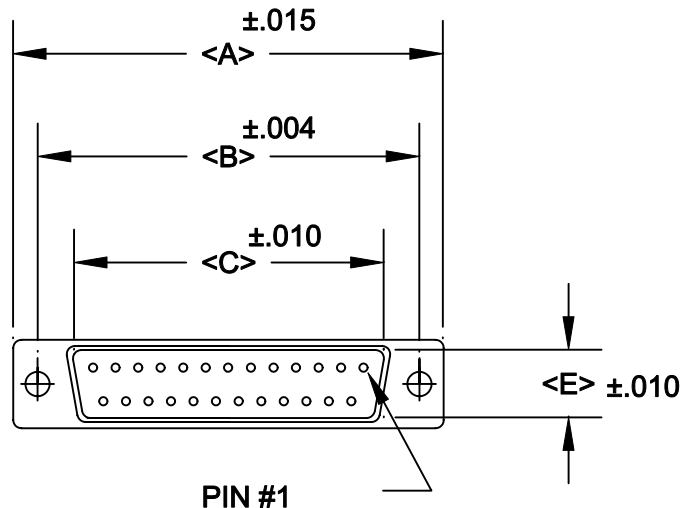

**SPECIFICATIONS:**

**MATERIALS:**

SHELL: STEEL, TIN PLATED

INSULATOR: UL 94V-0 RATED PBTP-BEIGE

+30% FIBER-GLASS - 260°C PROCESS TEMP.

CONTACTS: BRASS

RoHS COMPLIANT

**ELECTRICALS:**

CURRENT RATING: 5 AMPS

CONTACT RESISTANCE: 15 mOHMS MAX

INSULATOR RESISTANCE: 1000 MOHMS MIN

VOLTAGE: 500V AC FOR 1 MINUTE

TEMPERATURE: -50°C TO +100°C

POS.	A	B	C	D	E	F	G
09	1.213	0.984	0.642	0.756	0.311	0.109	0.496
	30.80	24.99	16.30	19.20	7.90	2.77	12.60
15	1.541	1.312	0.971	1.091	0.311	0.109	0.496
	39.14	33.32	24.65	27.70	7.90	2.77	12.60
25	2.087	1.852	1.512	1.618	0.311	0.109	0.496
	53.00	47.04	38.40	41.10	7.90	2.77	12.60
37	2.728	2.500	2.157	2.256	0.311	0.109	0.496
	69.29	63.50	54.80	57.30	7.90	2.77	12.60
50	2.638	2.406	2.055	2.169	0.429	0.109	0.602
	67.00	61.00	52.20	55.10	10.90	2.77	15.30

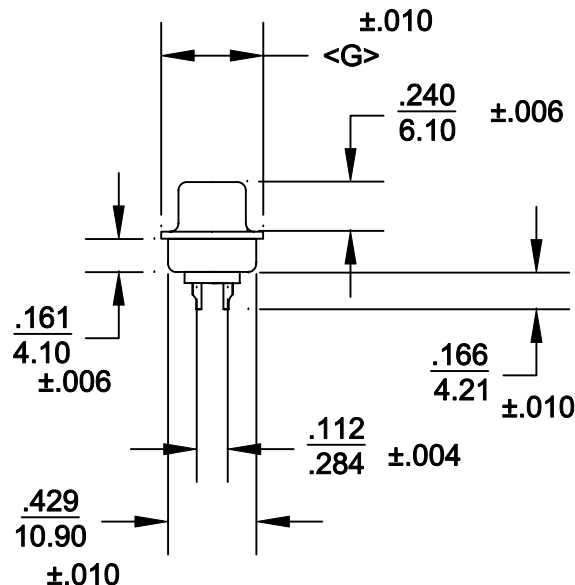

- 172-XXX-202RXX1
- SERIES \_\_\_\_\_
- POSITIONS \_\_\_\_\_
- 009  
015  
025  
037  
050
- GENDER \_\_\_\_\_
- 1 = MALE  
2 = FEMALE
- TERMINATION \_\_\_\_\_
- 0 = SOLDER CUP
- SHELL PLATING \_\_\_\_\_
- 2 = TIN
- HARDWARE OPTIONS \_\_\_\_\_
- 00 = NO HARDWARE  
01 = .065 4-40 CLINCH NUT BOARD SIDE  
02 = .250 4-40 CLINCH NUT BOARD SIDE  
03 = .250 4-40 CLINCH NUT MATING SIDE
- PLATING OPTIONS \_\_\_\_\_
- 1 = GOLD FLASH  
2 = 30 MICRO-INCH GOLD

**WILL ACCEPT 28-20 AWG CONDUCTORS**

	THESE DRAWINGS AND SPECIFICATIONS ARE THE PROPERTY OF NorComp AND SHALL NOT BE REPRODUCED, COPIED OR USED AS THE BASIS FOR THE MANUFACTURE OR SALE OF APPARATUS WITHOUT WRITTEN PERMISSION.	DRAWN: <b>PAM JENKINS</b>	DATE: <b>8-24-05</b>	
		CHECKED:	DATE:	
<h1>NorComp</h1>		SCALE:	SHEET OF	REV <b>3</b>
		DWG NO. <b>172-XXX-202RXX1</b>		

**DESCRIPTION: CLINCH NUT HARDWARE**

ALL CLINCH-NUTS ARE 4-40 INTERNAL THREADS

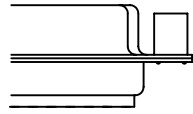

03X..... .250" (MATING SIDE) - CN8

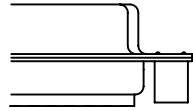

02X ..... .250" (BOARD SIDE) - CN2

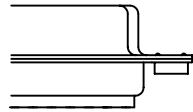

01X ..... .065" (BOARD SIDE) - CN1

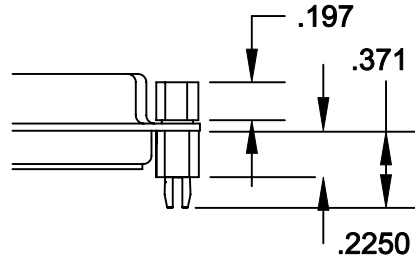

91X ..... .225" (BOARD SIDE) - .197 MATING SIDE - CN10/SFS0440

NOTE: 4-40 FEMALE SCREW LOCK IS REMOVABLE

	THESE DRAWINGS AND SPECIFICATIONS ARE THE PROPERTY OF NorComp AND SHALL NOT BE REPRODUCED, COPIED OR USED AS THE BASIS FOR THE MANUFACTURE OF SALE OF APPARATUS WITHOUT WRITTEN PERMISSION.		DRAWN: WAYNE ROBBINS	DATE: 8-23-98
	<b>NorComp</b>		CHECKED: PAM JENKINS	DATE: 8-24-98
SCALE:			SHEET 1 OF 1	REV 3
DWG NO. 172-XXX-202RXX1				