

PLEASE CHECK WWW.MOLEX.COM FOR LATEST PART INFORMATION

Part Number: [171574-1815](#)
Status: **Active**
Overview: [Impact™ Backplane Connectors and Cable Assemblies](#)
Description: Impact™ 100 Ohm Right-Angle Orthogonal Direct Header, 4-Pair, Unguided, Dual Endwall, with Outrigger, 8 Column, 32 Differential Pair, Pin Length 5.50mm, .46 Plated Through-Hole, Lead-Free

Documents:

[Drawing \(PDF\)](#) [RoHS Certificate of Compliance \(PDF\)](#)
[Product Specification PS-76060-999 \(PDF\)](#)

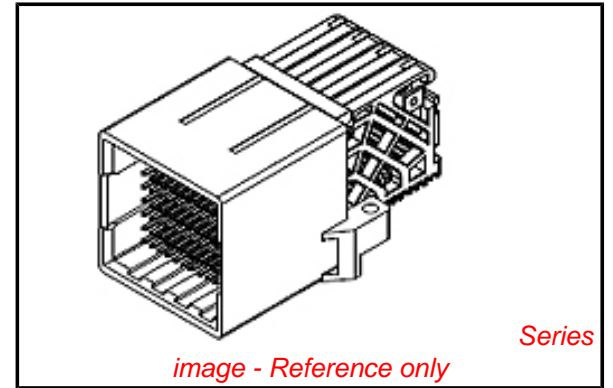

General

Product Family	Backplane Connectors
Series	171574
Application	Orthogonal Direct
Component Type	PCB Header
Overview	Impact™ Backplane Connectors and Cable Assemblies
Product Name	Impact™
Style	N/A
UPC	887191307282

Physical

Circuits (Loaded)	96
Circuits (maximum)	96
Color - Resin	Black
Durability (mating cycles max)	200
First Mate / Last Break	No
Guide to Mating Part	No
Keying to Mating Part	None
Material - Metal	High Performance Alloy (HPA)
Material - Plating Mating	Gold
Material - Plating Termination	Tin
Material - Resin	High Temperature Thermoplastic
Net Weight	18.623/g
Number of Columns	8
Number of Pairs	4
Number of Rows	12
Orientation	Right Angle
PC Tail Length	1.20mm
PCB Locator	No
PCB Retention	Yes
PCB Thickness - Recommended	1.00mm
Packaging Type	Tray
Pitch - Mating Interface	1.35mm, 1.90mm, 2.15mm
Pitch - Termination Interface	1.35mm, 1.90mm, 2.15mm
Plating min - Mating	0.762µm
Polarized to PCB	Yes
Stackable	No
Surface Mount Compatible (SMC)	No
Temperature Range - Operating	-55°C to +85°C
Termination Interface: Style	Through Hole - Compliant Pin

Electrical

Current - Maximum per Contact	0.75A
Data Rate	25.0 Gbps
Impedance	100#

EU RoHS

ELV and RoHS Compliant

REACH SVHC

Not Reviewed

Low-Halogen Status

Not Low-Halogen

China RoHS



Need more information on product environmental compliance?

Email productcompliance@molex.com
 For a multiple part number RoHS Certificate of Compliance, [click here](#)

Please visit the [Contact Us](#) section for any non-product compliance questions.

Search Parts in this Series

[171574Series](#)

Mates With

76850 Impact™ 100 Ohm Right Angle Orthogonal Daughtercard

Application Tooling | FAQ

Tooling specifications and manuals are found by selecting the products below. Crimp Height Specifications are then contained in the Application Tooling Specification document.

Global

Description	Product #
Impact Daughter	0622024300
Card Extraction Tool	
Impact™ Orthogonal	0622030027
Direct Ram Module	
Installation Press-In Tool 4-Pair by 8 Column	

Shield Type	N/A
Shielded	No
Voltage - Maximum	30V AC (RMS)/DC

Material Info

Reference - Drawing Numbers

Product Specification	PS-76060-999
Sales Drawing	SD-171574-0001
Symbol/Footprint Data	SYM-171574-1815

This document was generated on 07/10/2013

PLEASE CHECK WWW.MOLEX.COM FOR LATEST PART INFORMATION