



PIDG

TE Internal #: 171507-2

Closed Ring Tongue Terminal, 22 – 18 AWG, M8 / 5/16 Stud Size, 8.33 mm [.328 in] Stud Diameter, Closed Barrel, Straight, Tin, PIDG

[View on TE.com >](#)

Terminals & Splices > Ring Terminals

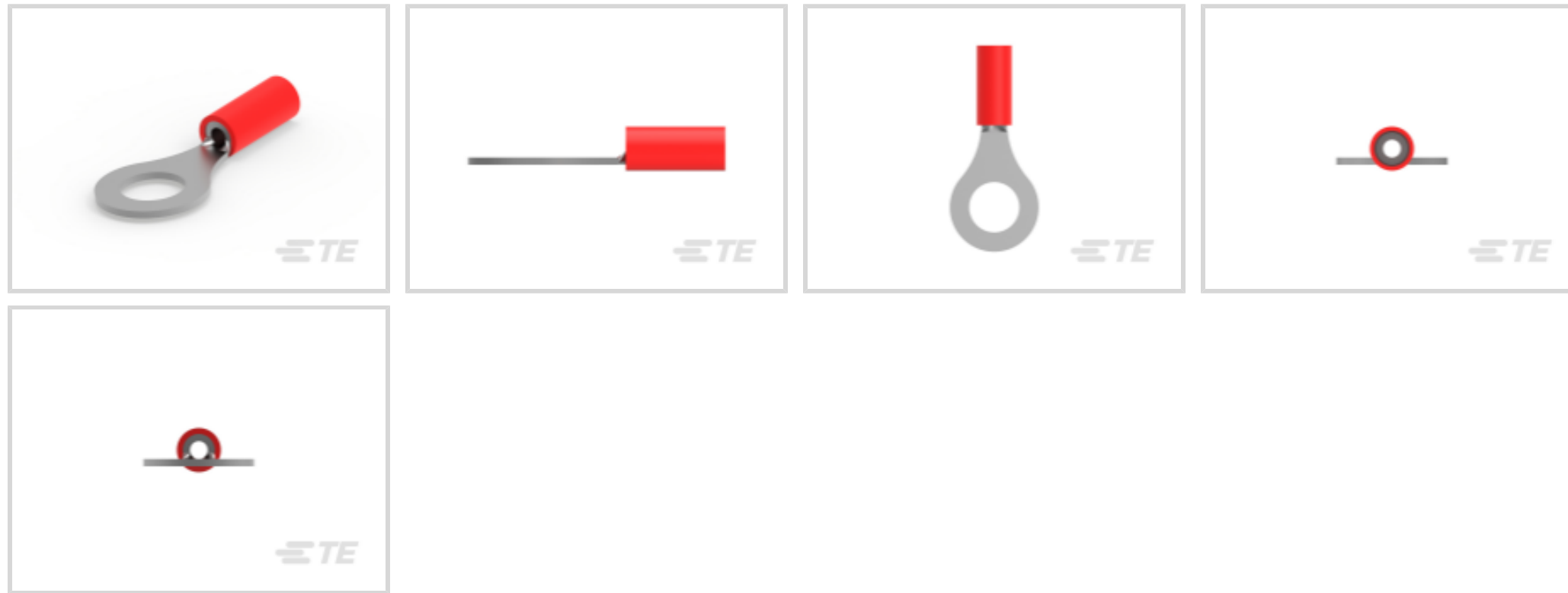

Ring Terminal Product Type: Closed Ring Tongue Terminal

Wire Size: 509 – 3260 CMA

Stud Size: 5/16, M8

Features

Product Type Features

Ring Terminal Product Type	Closed Ring Tongue Terminal
Stud Size	5/16, M8
Sealable	No
Wire Insulation Support Retention Type	Insulation Support

Configuration Features

Number of Holes	1
-----------------	---

Electrical Characteristics

Voltage Rating	300 V
----------------	-------

Body Features

Insulation Sleeve Color	Red
Stripe Color	Red

Contact Features

Barrel Type	Closed
Terminal Orientation	Straight
Terminal Plating Material	Tin



### Mechanical Attachment

Wire Insulation Support	With
-------------------------	------

### Dimensions

Wire Size	509 – 3260 CMA
Stud Diameter	8.33 mm [.328 in]
Tongue Thickness	.79 mm [.031 in]
Product Length	27.6 mm [1.076 in]
Compatible Insulation Diameter (Max)	3.18 mm [.125 in]
Compatible Insulation Diameter Range	2.03 – 3.18 mm [.08 – .125 in]

### Usage Conditions

Insulation Option	Partially Insulated
Operating Temperature Range	105 °C [221 °F]

### Operation/Application

Compatible With Wire Base Material	Copper
Compatible With Wire Plating Material	Tin

### Industry Standards

Government Qualified Terminal	No
-------------------------------	----

### Packaging Features

Packaging Quantity	100
Packaging Method	Bag

### Product Compliance

[For compliance documentation, visit the product page on TE.com>](#)

EU RoHS Directive 2011/65/EU	Compliant
EU ELV Directive 2000/53/EC	Compliant
China RoHS 2 Directive MIIT Order No 32, 2016	No Restricted Materials Above Threshold
EU REACH Regulation (EC) No. 1907/2006	Current ECHA Candidate List: JUNE 2023 (235) Candidate List Declared Against: JUNE 2023 (235) Does not contain REACH SVHC
Halogen Content	Not Low Halogen - contains Br or Cl > 900 ppm.
Solder Process Capability	Not applicable for solder process capability

Product Compliance Disclaimer

This information is provided based on reasonable inquiry of our suppliers and represents our current actual knowledge based on the information they provided. This information is subject to change. The part numbers that TE has identified as EU RoHS compliant have a maximum concentration of 0.1% by weight in homogenous materials for lead, hexavalent chromium, mercury, PBB, PBDE, DBP, BBP, DEHP, DIBP, and 0.01% for cadmium, or qualify for an exemption to these limits as defined in the Annexes of Directive 2011/65/EU (RoHS2). Finished electrical and electronic equipment products will be CE marked as required by Directive 2011/65/EU. Components may not be CE marked. Additionally, the part numbers that TE has identified as EU ELV compliant have a maximum concentration of 0.1% by weight in homogenous materials for lead, hexavalent chromium, and mercury, and 0.01% for cadmium, or qualify for an exemption to these limits as defined in the Annexes of Directive 2000/53/EC (ELV). Regarding the REACH Regulation, the information TE provides on SVHC in articles for this part number is based on the latest European Chemicals Agency (ECHA) 'Guidance on requirements for substances in articles' posted at this URL: <https://echa.europa.eu/guidance-documents/guidance-on-reach>

## Compatible Parts



REPRESENTATION ONLY

TE Part # 47386  
 DAHT PG PIDG 26-16 ASSY



TE Part # 58433-3  
 PRO CR ASSY, RBY IS9252



TE Part # 58423-1  
 DIE, RBY IS9252



TE Part # 47806-2  
 DIES PIDG 22-16 DIE SET



TE Part # 169404  
 CERTI-LOK DIE



TE Part # 1SET191001R0000  
 CRIMP-HT

## Also in the Series | PIDG



Compression Connectors(17)



Crimp Terminal Housings(1)



Crimp Wire Pins, Tabs & Ferrules(41)



Hand Crimping Tools(2)



Knife Disconnects(11)



PCB Terminals(5)

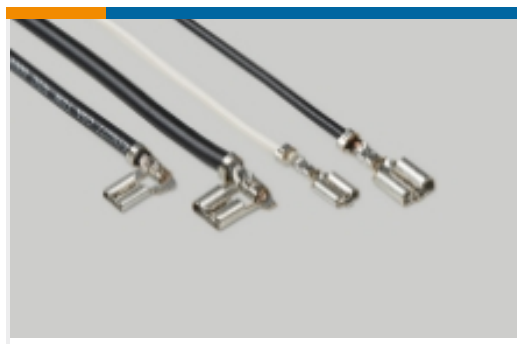

Quick Disconnects(47)



Ring Terminals(589)

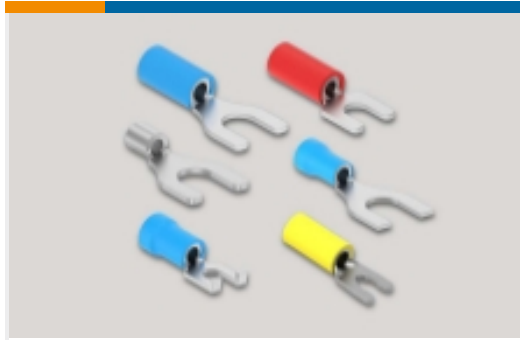

Spade Terminals(230)



Special Purpose Terminals(1)



Splices(43)

## Customers Also Bought



TE Part #2098251-1  
Contacts: Size 16, 13A



TE Part #213894-2  
CPC RECPT SEALED SIZE 17-10

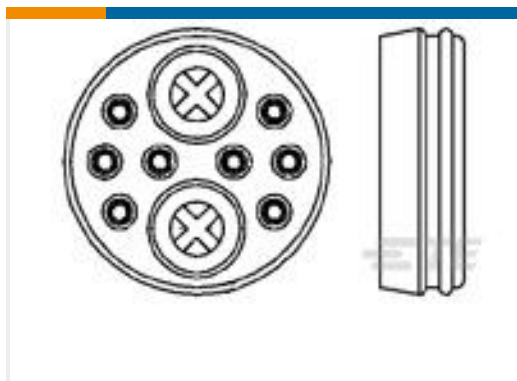

TE Part #213900-1  
CPC SEAL ASSY KIT,SRS 6,17-10

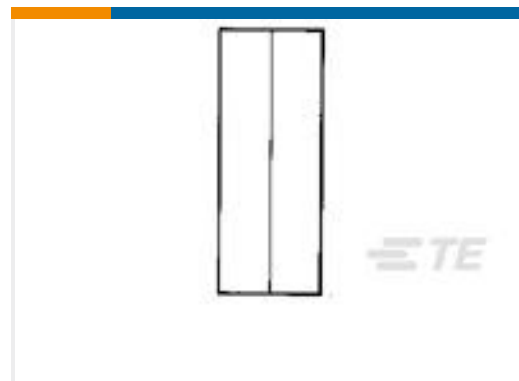

TE Part #34130  
SPLICE,SOLIS PARA 22-16



TE Part #770088-1  
06P .093 COMM P&S RECPT HSG



TE Part #1-1241418-3  
AMP MCP 6.3/4.8K, CONTACT, SWS



TE Part #YHDP26-24-19PEL024  
PLG, 19P, BLK, E, WTHD, 12/16, P



TE Part #696423-5  
TERMINAL,PIDG PVF2 R 16-14 8



TE Part #NB10332001  
ATUM-24/8-0-MS-STK

## Documents



### Product Drawings

#### PIDG RING UL.CSA(22-18)

English

---

### CAD Files

#### 3D PDF

3D

#### Customer View Model

[ENG\\_CVM\\_CVM\\_171507-2\\_D.2d\\_dxf.zip](#)

English

#### Customer View Model

[ENG\\_CVM\\_CVM\\_171507-2\\_D.3d\\_igs.zip](#)

English

#### Customer View Model

[ENG\\_CVM\\_CVM\\_171507-2\\_D.3d\\_stp.zip](#)

English

By downloading the CAD file I accept and agree to the [Terms and Conditions](#) of use.

---

### Product Specifications

English

#### PIDG Solderless Terminals and Splice with Insulation Sleeve

English

---

### Agency Approvals

#### UL Report

English