

PCB terminal block - MKDS 3/ 3 BK - 1714243

Please be informed that the data shown in this PDF Document is generated from our Online Catalog. Please find the complete data in the user's documentation. Our General Terms of Use for Downloads are valid (<http://phoenixcontact.com/download>)



PCB terminal block, Nominal current: 24 A, Nom. voltage: 400 V, Pitch: 5 mm, Number of positions: 3, Connection method: Screw connection, Mounting: Soldering, Conductor/PCB connection direction: 0 °, Color: black, The article can be aligned to create different nos. of positions!

The illustration shows a combination as a 15-position version, in green



Key Commercial Data

Packing unit	1 pc
Minimum order quantity	50 pc
Weight per Piece (excluding packing)	6.29 g
Custom tariff number	85369010
Country of origin	Germany

Technical data

Dimensions

Length	11.2 mm
Pitch	5.00 mm
Dimension a	10 mm
Constructional height	23 mm
Height	18 mm
Length of the solder pin	5 mm
Pin dimensions	0,9 x 0,9 mm
Pin spacing	5 mm
Hole diameter	1.3 mm

General

Range of articles	MKDS 3
Insulating material group	I
Rated surge voltage (III/3)	4 kV

PCB terminal block - MKDS 3/ 3 BK - 1714243

Technical data

General

Rated surge voltage (III/2)	4 kV
Rated surge voltage (II/2)	4 kV
Rated voltage (III/3)	250 V
Rated voltage (III/2)	400 V
Rated voltage (II/2)	630 V
Connection in acc. with standard	EN-VDE
Nominal current I_N	24 A
Nominal cross section	2.5 mm ²
Maximum load current	28 A (with 4 mm ² conductor cross section)
Insulating material	PA
Solder pin surface	Sn
Flammability rating according to UL 94	V0
Internal cylindrical gage	A3
Stripping length	8 mm
Number of positions	3
Screw thread	M3
Tightening torque, min	0.5 Nm
Tightening torque max	0.6 Nm

Connection data

Conductor cross section solid min.	0.2 mm ²
Conductor cross section solid max.	4 mm ²
Conductor cross section flexible min.	0.2 mm ²
Conductor cross section flexible max.	2.5 mm ²
Conductor cross section flexible, with ferrule without plastic sleeve min.	0.25 mm ²
Conductor cross section flexible, with ferrule without plastic sleeve max.	2.5 mm ²
Conductor cross section flexible, with ferrule with plastic sleeve min.	0.25 mm ²
Conductor cross section flexible, with ferrule with plastic sleeve max.	2.5 mm ²
Conductor cross section AWG min.	24
Conductor cross section AWG max.	12
2 conductors with same cross section, solid min.	0.2 mm ²
2 conductors with same cross section, solid max.	1.5 mm ²
2 conductors with same cross section, stranded min.	0.2 mm ²
2 conductors with same cross section, stranded max.	1.5 mm ²
2 conductors with same cross section, stranded, ferrules without plastic sleeve, min.	0.25 mm ²
2 conductors with same cross section, stranded, ferrules without plastic sleeve, max.	0.75 mm ²

PCB terminal block - MKDS 3/ 3 BK - 1714243

Technical data

Connection data

2 conductors with same cross section, stranded, TWIN ferrules with plastic sleeve, min.	0.5 mm ²
2 conductors with same cross section, stranded, TWIN ferrules with plastic sleeve, max.	1.5 mm ²

Standards and Regulations

Connection in acc. with standard	EN-VDE
	CSA
Flammability rating according to UL 94	V0

Classifications

eCl@ss

eCl@ss 4.0	27141109
eCl@ss 4.1	27141109
eCl@ss 5.0	27141190
eCl@ss 5.1	27141190
eCl@ss 6.0	27261101
eCl@ss 7.0	27440401
eCl@ss 8.0	27440401

ETIM

ETIM 3.0	EC001121
ETIM 4.0	EC002643
ETIM 5.0	EC002643

UNSPSC

UNSPSC 6.01	30211801
UNSPSC 7.0901	39121432
UNSPSC 11	39121432
UNSPSC 12.01	39121432
UNSPSC 13.2	39121432

Approvals

Approvals

Approvals

CSA / UL Recognized / SEV / cUL Recognized / CCA / EAC / cULus Recognized

PCB terminal block - MKDS 3/ 3 BK - 1714243

Approvals

Ex Approvals

Approvals submitted

Approval details

CSA		
	B	D
mm ² /AWG/kcmil	28-12	28-12
Nominal current I _N	10 A	10 A
Nominal voltage U _N	300 V	300 V

UL Recognized		
	B	D
mm ² /AWG/kcmil	30-12	30-12
Nominal current I _N	15 A	10 A
Nominal voltage U _N	300 V	300 V

SEV	
mm ² /AWG/kcmil	4
Nominal voltage U _N	250 V

cUL Recognized		
	B	D
mm ² /AWG/kcmil	30-12	30-12
Nominal current I _N	15 A	10 A
Nominal voltage U _N	300 V	300 V

PCB terminal block - MKDS 3/ 3 BK - 1714243

Approvals

CCA	
mm ² /AWG/kcmil	4
Nominal voltage UN	250 V

EAC

cULus Recognized  US

Drawings

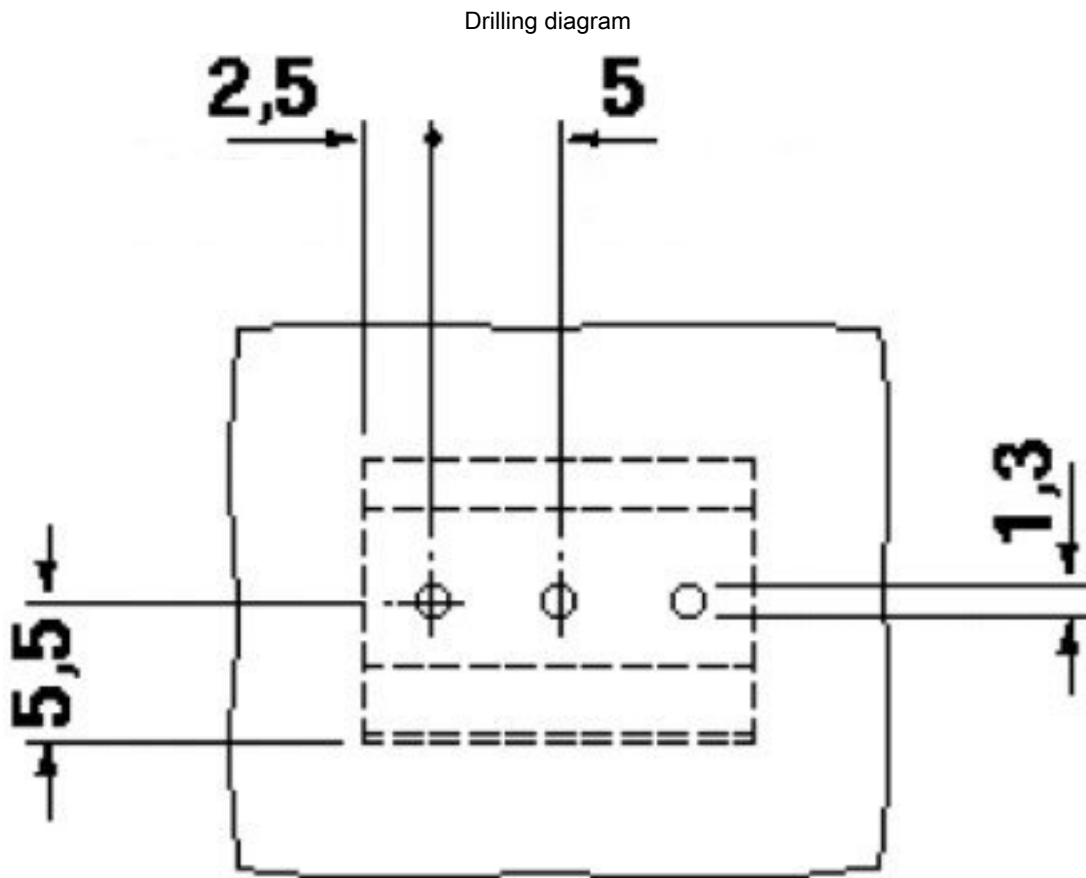

PCB terminal block - MKDS 3/ 3 BK - 1714243

Dimensional drawing

