

SPC 16/ 3-ST-10,16 - PCB connector



1711271

<https://www.phoenixcontact.com/pc/products/1711271>

Please be informed that the data shown in this PDF document is generated from our Online Catalog. Please find the complete data in the user documentation. Our General Terms of Use for Downloads are valid.



PCB connector, nominal cross section: 16 mm², color: green, nominal current: 76 A, rated voltage (III/2): 1000 V, contact surface: Silver, type of contact: Socket, number of potentials: 3, number of rows: 1, number of positions: 3, number of connections: 3, product range: SPC 16/..-ST, pitch: 10.16 mm, connection method: Push-in spring connection, conductor/PCB connection direction: 0 °, locking clip: - without locking clip, plug-in system: COMBICON PC 16, locking: without, mounting: without, type of packaging: packed in cardboard

Your advantages

- Time saving push-in connection, tools not required
- Defined contact force ensures that contact remains stable over the long term
- Clamping space opened by means of fixed screwdriver enables convenient conductor connection
- Integrated double steel spring provides additional safety in the event of temperature and power fluctuations
- Optimized for tight installation situations: operation and conductor connection from one direction

Commercial Data

Item number	1711271
Packing unit	50 pc
Minimum order quantity	50 pc
Product Key	AAEFAA
Catalog Page	Page 562 (C-1-2013)
GTIN	4046356080859
Weight per Piece (including packing)	24.8 g
Weight per Piece (excluding packing)	23.687 g
Customs tariff number	85366990
Country of origin	IN

SPC 16/ 3-ST-10,16 - PCB connector



1711271

<https://www.phoenixcontact.com/pc/products/1711271>

Technical Data

Product properties

Type	Plug component
Product line	COMBICON Connectors XL
Product type	PCB connector
Product family	SPC 16/...-ST
Number of positions	3
Pitch	10.16 mm
Number of connections	3
Number of rows	1
Mounting flange	without
Number of potentials	3

Electrical properties

Nominal current I_N	76 A
Nominal voltage U_N	1000 V
Degree of pollution	3
Contact resistance	0.5 m Ω
Rated voltage (III/3)	1000 V
Rated surge voltage (III/3)	8 kV
Rated voltage (III/2)	1000 V
Rated surge voltage (III/2)	8 kV
Rated voltage (II/2)	1000 V
Rated surge voltage (II/2)	6 kV

Connection data

Connection technology

Type	Standard
Connector system	COMBICON PC 16
Nominal cross section	16 mm ²
Type of contact	Socket

Interlock

Locking type	without
Mounting flange	without

Conductor connection

Connection method	Push-in spring connection
Conductor/PCB connection direction	0 °
Conductor cross section rigid	0.75 mm ² ... 16 mm ²
Conductor cross section flexible	0.75 mm ² ... 16 mm ²
Conductor cross section AWG	18 ... 4
Conductor cross section flexible, with ferrule without plastic	0.75 mm ² ... 16 mm ²

SPC 16/ 3-ST-10,16 - PCB connector

1711271

<https://www.phoenixcontact.com/pc/products/1711271>

sleeve	
Conductor cross section, flexible, with ferrule, with plastic sleeve	0.75 mm ² ... 10 mm ²
2 conductors with the same cross section, flexible, with TWIN ferrule with plastic sleeve	0.75 mm ² ... 4 mm ²
Cylindrical gauge a x b / diameter	- / 5.4 mm
Stripping length	18 mm

Material specifications

Material data - contact

Note	WEEE/RoHS-compliant, free of whiskers according to IEC 60068-2-82/JEDEC JESD 201
Contact material	Cu alloy
Surface characteristics	Silver-plated strip
Metal surface terminal point (top layer)	Silver (4 - 8 µm Ag)
Metal surface contact area (top layer)	Silver (4 - 8 µm Ag)

Material data - housing

Color (Housing)	green (6021)
Insulating material	PA
Insulating material group	I
CTI according to IEC 60112	600
Flammability rating according to UL 94	V0
Glow wire flammability index GWFI according to EN 60695-2-12	850
Glow wire ignition temperature GWIT according to EN 60695-2-13	775
Temperature for the ball pressure test according to EN 60695-10-2	125 °C

Dimensions

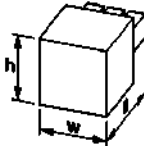
Dimensional drawing	
Pitch	10.16 mm
Width [w]	30.48 mm
Height [h]	25.1 mm
Length [l]	44.5 mm

Mounting

Connection method	Push-in spring connection
-------------------	---------------------------

Notes

Notes on operation	In accordance with IEC 61984, COMBICON connectors have no switching power (COC). During designated use, they must not be
--------------------	--

SPC 16/ 3-ST-10,16 - PCB connector



1711271

<https://www.phoenixcontact.com/pc/products/1711271>

plugged in or disconnected when carrying voltage or under load.

Mechanical tests

Conductor connection

Specification	IEC 60999-1:1999-11
Result	Test passed

Test for conductor damage and slackening

Specification	IEC 60999-1:1999-11
Result	Test passed

Repeated connection and disconnection

Specification	IEC 60999-1:1999-11
Result	Test passed

Pull-out test

Specification	IEC 60999-1:1999-11
Conductor cross section/conductor type/tractive force setpoint/actual value	0.75 mm ² / solid / > 30 N
	0.75 mm ² / flexible / > 30 N
	16 mm ² / solid / > 100 N
	16 mm ² / flexible / > 100 N

Insertion and withdrawal forces

Result	Test passed
No. of cycles	50
Insertion strength per pos. approx.	7 N
Withdraw strength per pos. approx.	7 N

Resistance of inscriptions

Specification	IEC 60068-2-70:1995-12
Result	Test passed

Polarization and coding

Specification	IEC 60512-13-5:2006-02
Result	Test passed

Visual inspection

Specification	IEC 60512-1-1:2002-02
Result	Test passed

Dimension check

Specification	IEC 60512-1-2:2002-02
Result	Test passed

Environmental and real-life conditions

Vibration test

Specification	IEC 60068-2-6:2007-12
---------------	-----------------------

SPC 16/ 3-ST-10,16 - PCB connector



1711271

<https://www.phoenixcontact.com/pc/products/1711271>

Frequency	10 - 150 - 10 Hz
Sweep speed	1 octave/min
Amplitude	0.35 mm (10 Hz ... 60.1 Hz)
Sweep speed	5g (60.1 Hz ... 150 Hz)
Test duration per axis	2.5 h

Durability test

Specification	IEC 60512-9-1:2010-03
Impulse withstand voltage at sea level	9.8 kV
Contact resistance R ₁	0.5 mΩ
Contact resistance R ₂	0.5 mΩ
Insertion/withdrawal cycles	50
Insulation resistance, neighboring positions	> 5 MΩ

Climatic test

Specification	ISO 6988:1985-02
Corrosive stress	0.2 dm ³ SO ₂ on 300 dm ³ /40 °C/1 cycle
Thermal stress	100 °C/168 h
Power-frequency withstand voltage	4.26 kV

Ambient conditions

Ambient temperature (operation)	-40 °C ... 100 °C (dependent on the derating curve)
Ambient temperature (storage/transport)	-40 °C ... 70 °C
Relative humidity (storage/transport)	30 % ... 70 %
Ambient temperature (assembly)	-5 °C ... 100 °C

Electrical tests

Thermal test | Test group C

Specification	IEC 60512-5-1:2002-02
Tested number of positions	9

Insulation resistance

Specification	IEC 60512-3-1:2002-02
Insulation resistance, neighboring positions	> 5 MΩ

Temperature cycles

Specification	IEC 60999-1:1999-11
Result	Test passed

Air clearances and creepage distances |

Specification	IEC 60664-1:2007-04
Insulating material group	I
Comparative tracking index (IEC 60112)	CTI 600
Rated insulation voltage (III/3)	1000 V
Rated surge voltage (III/3)	8 kV
minimum clearance value - non-homogenous field (III/3)	8 mm

SPC 16/ 3-ST-10,16 - PCB connector



1711271

<https://www.phoenixcontact.com/pc/products/1711271>

minimum creepage distance (III/3)	12.5 mm
Rated insulation voltage (III/2)	1000 V
Rated surge voltage (III/2)	8 kV
minimum clearance value - non-homogenous field (III/2)	8 mm
minimum creepage distance (III/2)	8 mm
Rated insulation voltage (II/2)	1000 V
Rated surge voltage (II/2)	6 kV
minimum clearance value - non-homogenous field (II/2)	5.5 mm
minimum creepage distance (II/2)	5.5 mm

Drawings

Diagram

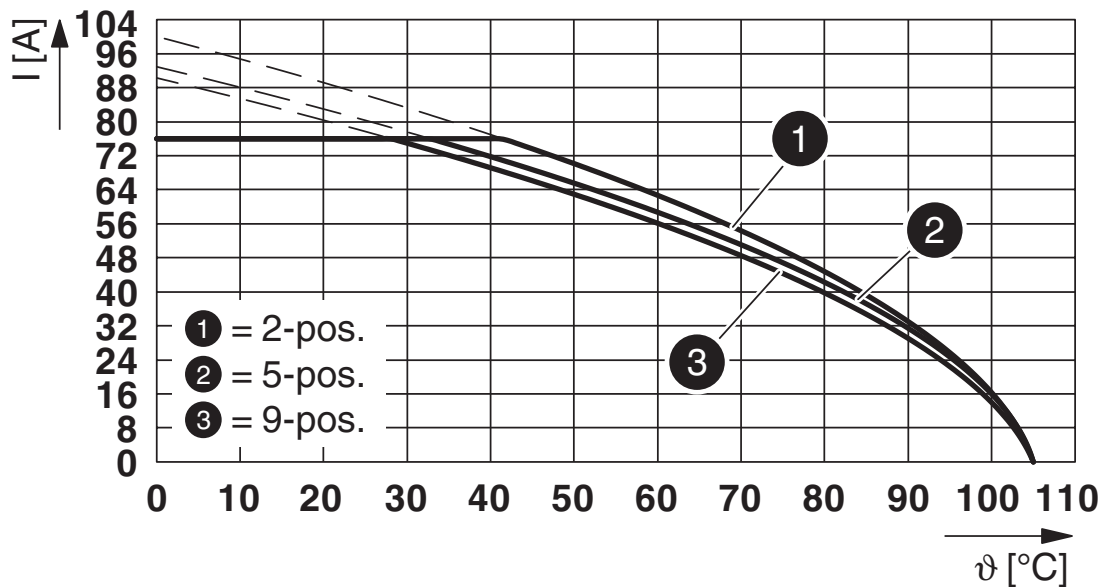

Type: SPC 16/...-ST-10,16 with IPC 16/...-ST-10,16

Diagram

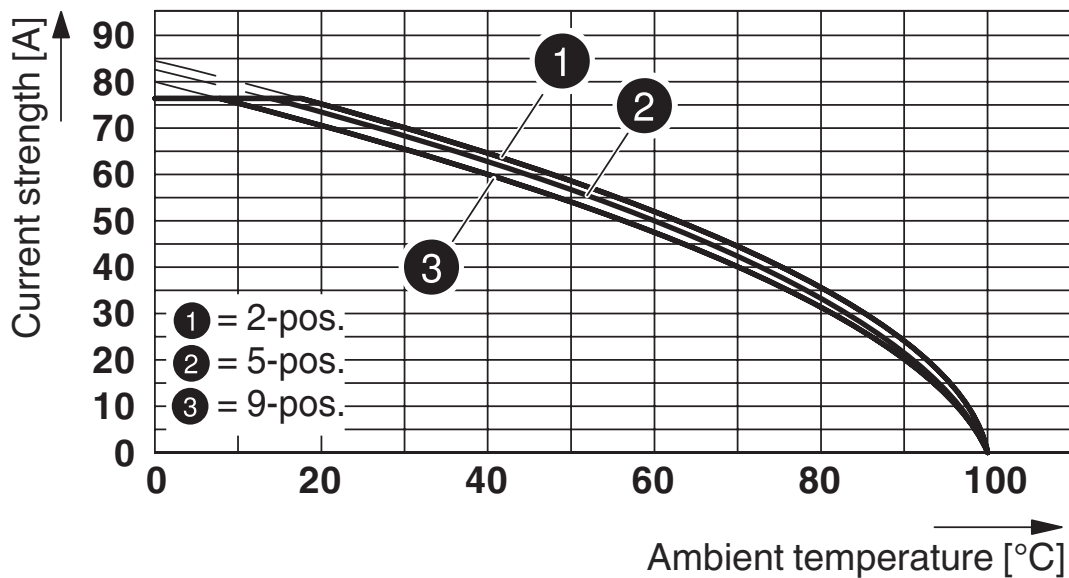

Type: SPC 16/...-ST(F)-10,16 with DFK-PC 16/...-ST(F)-10,16

Diagram

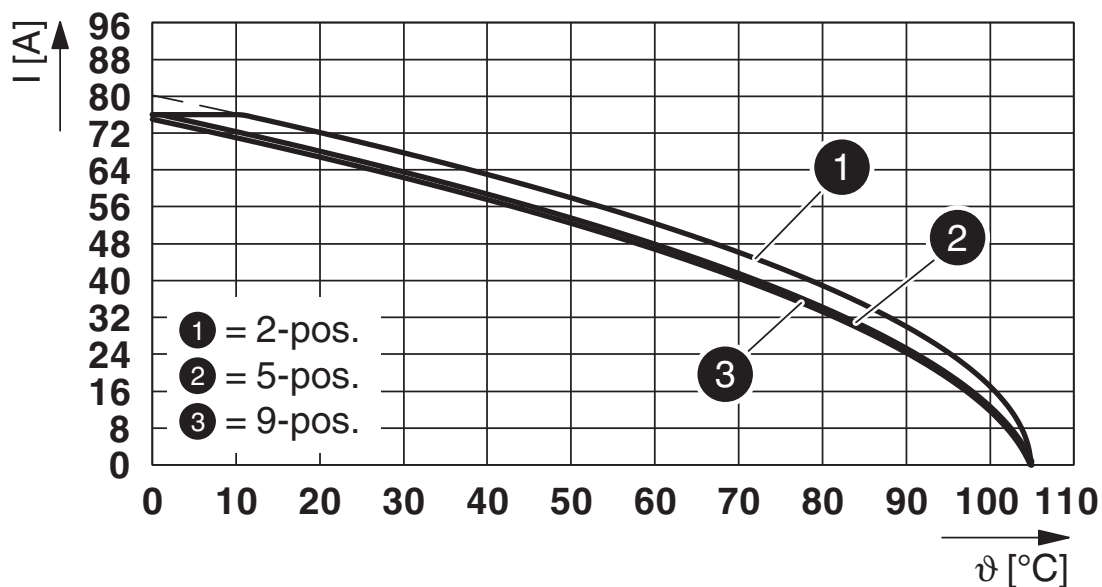

Type: SPC 16/...-ST-10,16 with PCV 6-16/...-G-10,16

Diagram

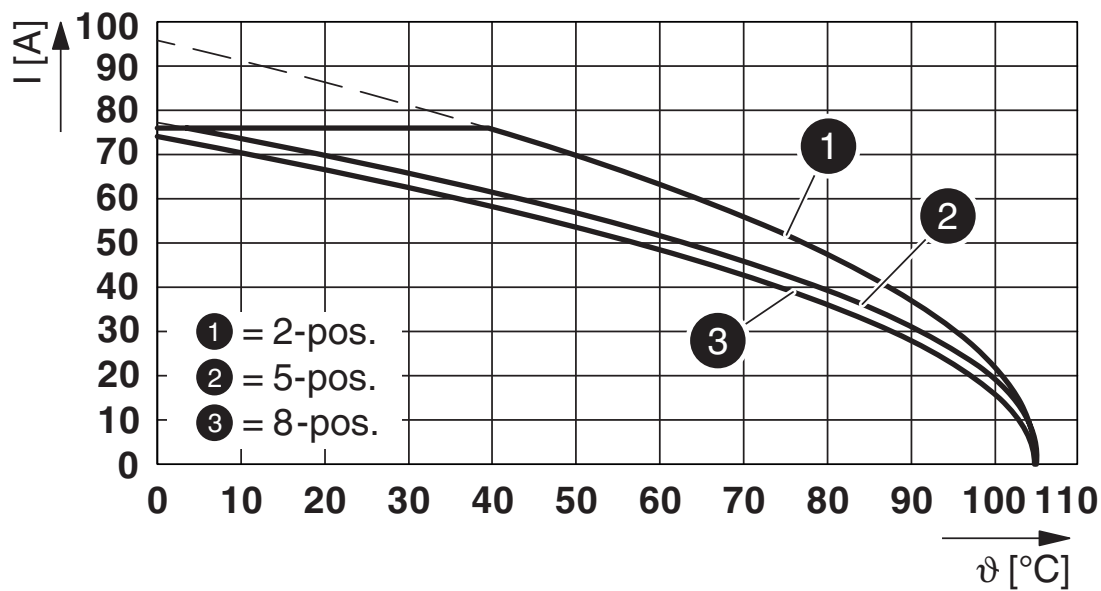

Type: SPC 16/...-ST-10,16 with PC 6-16/...-G-10,16

SPC 16/ 3-ST-10,16 - PCB connector



1711271

<https://www.phoenixcontact.com/pc/products/1711271>

Diagram

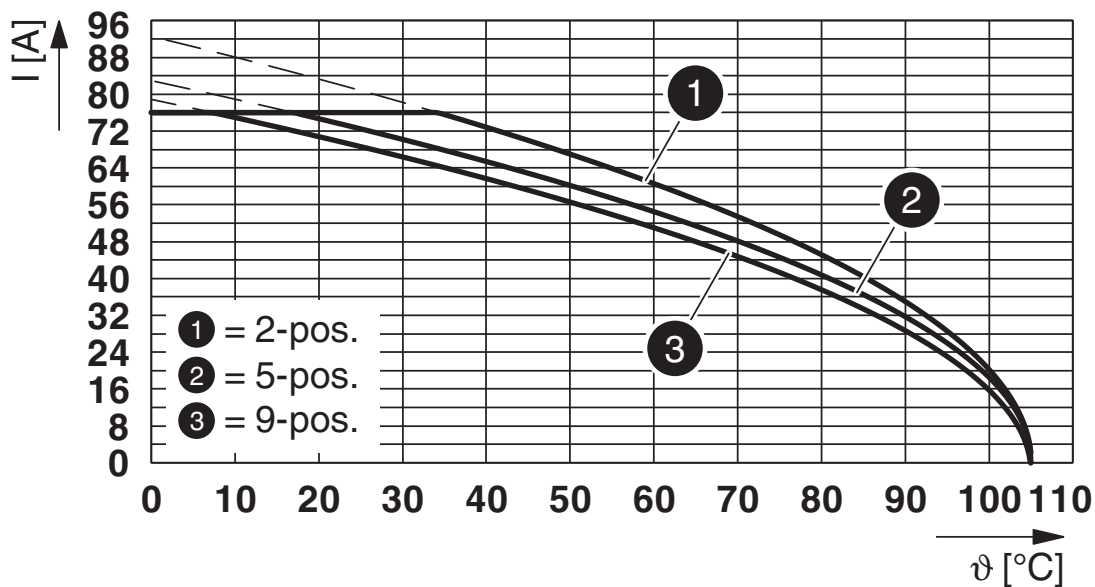

Type: SPC 16/...-ST-10,16 with PCV 6-16/...-G1-10,16

Diagram

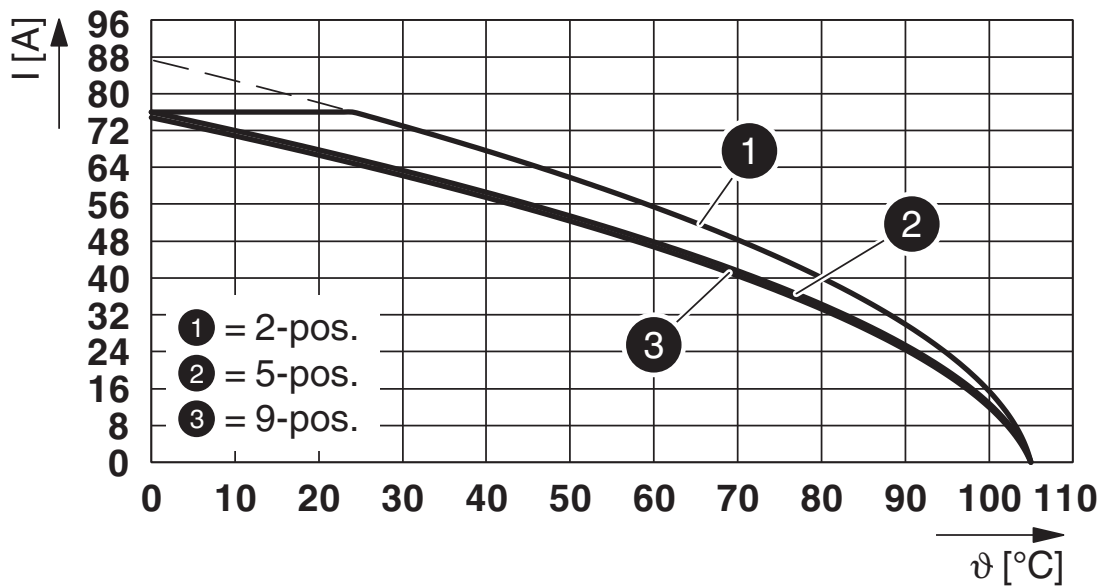

Type: SPC 16/...-ST-10,16 with PC 6-16/...-G1-10,16

SPC 16/ 3-ST-10,16 - PCB connector



1711271

<https://www.phoenixcontact.com/pc/products/1711271>

Diagram

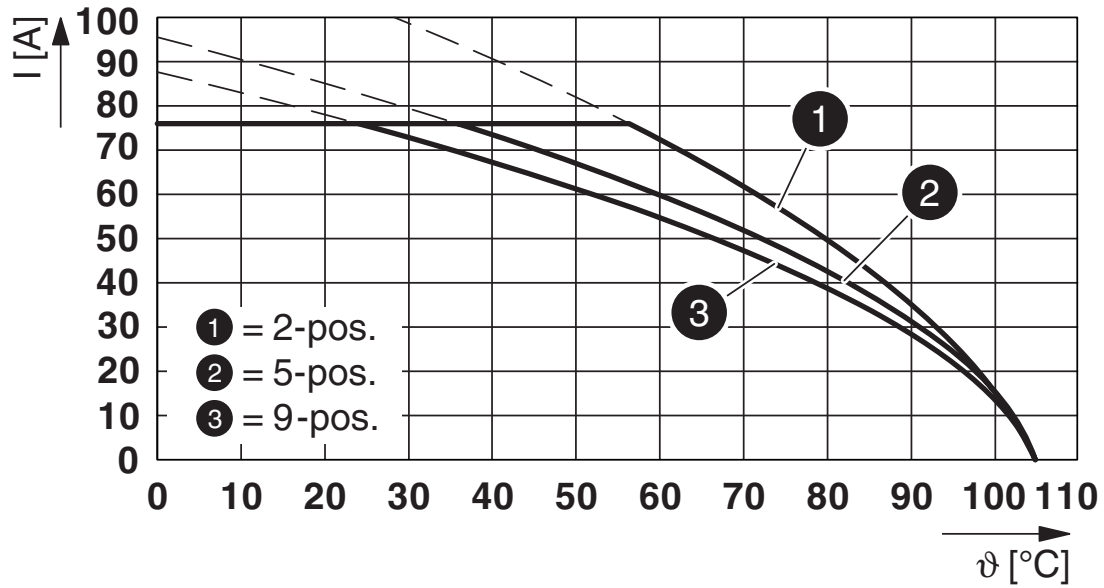

Type: SPC 16/...-ST-10,16 with ISPC 16/...-ST-10,16

SPC 16/ 3-ST-10,16 - PCB connector





1711271

<https://www.phoenixcontact.com/pc/products/1711271>

Approvals

To download certificates, visit the product detail page: <https://www.phoenixcontact.com/pc/products/1711271>

 **EAC**
Approval ID: B.01687

 **cULus Recognized**
Approval ID: E60425-20040202

	Nominal Voltage U_N	Nominal Current I_N	Cross Section AWG	Cross Section mm^2
Use group B	600 V	66 A	20 - 4	-
Use group C	600 V	66 A	20 - 4	-

 **IECEE CB Scheme**
Approval ID: DE1-66677

	Nominal Voltage U_N	Nominal Current I_N	Cross Section AWG	Cross Section mm^2
	1000 V	76 A	-	0.75 - 16

 **VDE Zeichengenehmigung**
Approval ID: 40055586

	Nominal Voltage U_N	Nominal Current I_N	Cross Section AWG	Cross Section mm^2
	1000 V	76 A	-	0.75 - 16

SPC 16/ 3-ST-10,16 - PCB connector



1711271

<https://www.phoenixcontact.com/pc/products/1711271>

Classifications

ECLASS

ECLASS-11.0	27460202
ECLASS-12.0	27460202
ECLASS-13.0	27460202

ETIM

ETIM 8.0	EC002638
----------	----------

UNSPSC

UNSPSC 21.0	39121400
-------------	----------

SPC 16/ 3-ST-10,16 - PCB connector



1711271

<https://www.phoenixcontact.com/pc/products/1711271>

Environmental Product Compliance

China RoHS	Environmentally friendly use period: unlimited = EFUP-e
	No hazardous substances above threshold values

SPC 16/ 3-ST-10,16 - PCB connector

1711271

<https://www.phoenixcontact.com/pc/products/1711271>

Accessories

CP-PC RD - Coding profile

1701967

<https://www.phoenixcontact.com/pc/products/1701967>

Coding profile, for plugging into the coding ribs of the plug at a later date, insulating material, color: Red



SZF 2-0,8X4,0 - Screwdriver

1204520

<https://www.phoenixcontact.com/pc/products/1204520>

Actuation tool, for ST terminal blocks, also suitable for use as a bladed screwdriver, size: 0.8 x 4.0 x 100 mm, 2-component grip, with non-slip grip



SPC 16/ 3-ST-10,16 - PCB connector

1711271

<https://www.phoenixcontact.com/pc/products/1711271>

SK 5,0 WH:REEL - Marker strip

0805221

<https://www.phoenixcontact.com/pc/products/0805221>



Marker strip, Roll, white, unlabeled, can be labeled with: THERMOMARK E.300 (D)/600 (D), THERMOMARK ROLL 2.0, THERMOMARK ROLL, THERMOMARK ROLL X1, THERMOMARK ROLLMASTER 300/600, THERMOMARK X1.2, mounting type: adhesive, for terminal block width: 5 mm, lettering field size: continuous x 5 mm, Number of individual labels: 90000

CRIMPFOX 6 - Crimping pliers

1212034

<https://www.phoenixcontact.com/pc/products/1212034>



Crimping pliers, for ferrules without insulating collar according to DIN 46228 Part 1 and ferrules with insulating collar according to DIN 46228 Part 4, 0.25 mm² ... 6.0 mm², lateral entry, trapezoidal crimp

SPC 16/ 3-ST-10,16 - PCB connector

1711271

<https://www.phoenixcontact.com/pc/products/1711271>

PCV 6-16/ 3-G1-10,16 - PCB header

1998797

<https://www.phoenixcontact.com/pc/products/1998797>



PCB headers, nominal cross section: 16 mm², color: green, nominal current: 76 A (41 A in combination with PC 6 plug), rated voltage (III/2): 1000 V, contact surface: Silver, type of contact: Pin, number of potentials: 3, number of rows: 1, number of positions: 3, number of connections: 3, product range: PCV 6-16/..-G1, pitch: 10.16 mm, mounting: Wave soldering, pin layout: Linear pinning, solder pin [P]: 4 mm, number of solder pins per potential: 3, plug-in system: COMBICON PC 16, Pin connector pattern alignment: Standard, locking: without, mounting: without, type of packaging: packed in cardboard

PC 6-16/ 3-G1-10,16 - PCB header

1998946

<https://www.phoenixcontact.com/pc/products/1998946>



PCB headers, nominal cross section: 16 mm², color: green, nominal current: 76 A (41 A in combination with PC 6 plug), rated voltage (III/2): 1000 V, contact surface: Silver, type of contact: Pin, number of potentials: 3, number of rows: 1, number of positions: 3, number of connections: 3, product range: PC 6-16/..-G1, pitch: 10.16 mm, mounting: Wave soldering, pin layout: Linear pinning, solder pin [P]: 4 mm, number of solder pins per potential: 3, plug-in system: COMBICON PC 16, Pin connector pattern alignment: Standard, locking: without, mounting: without, type of packaging: packed in cardboard

SPC 16/ 3-ST-10,16 - PCB connector



1711271

<https://www.phoenixcontact.com/pc/products/1711271>

DFK-PC 16/ 3-ST-10,16 - Feed-through plug

1703386

<https://www.phoenixcontact.com/pc/products/1703386>



Feed-through connector, nominal cross section: 16 mm², color: green, nominal current: 76 A, rated voltage (III/2): 1000 V, contact surface: Silver, type of contact: Pin, number of potentials: 3, number of rows: 1, number of positions: 3, number of connections: 3, product range: DFK-PC 16/..-ST, pitch: 10.16 mm, connection method: Screw connection with tension sleeve, screw head form: L Slotted, conductor/PCB connection direction: 0 °, plug-in system: COMBICON PC 16, Pin connector pattern alignment: Standard, locking: without, mounting: without, type of packaging: packed in cardboard

Phoenix Contact 2023 © - all rights reserved

<https://www.phoenixcontact.com>

PHOENIX CONTACT GmbH & Co. KG

Flachsmarktstraße 8

D-32825 Blomberg

+49 (0) 5235-3 00

info@phoenixcontact.com