



Connectors > PCB Connectors > Wire-to-Board Connectors > Wire-to-Board Connector Assemblies & Housings



Connector Product Type: **Housing**

Connector & Housing Type: **Receptacle**

Number of Positions: **6**

Centerline (Pitch): **5 mm [ .197 in ]**

Termination Method to Wire & Cable: **Insulation Displacement (IDC)**

## Features

### Product Type Features

Connector Product Type	Housing
Connector & Housing Type	Receptacle
Connector & Contact Terminates To	Wire & Cable

### Configuration Features

Keying & Polarized Rib Location	2 + 3
Number of Positions	6
Number of Rows	1

### Body Features

Primary Product Color	Gray
-----------------------	------

### Termination Features

Termination Method to Wire & Cable	Insulation Displacement (IDC)
------------------------------------	-------------------------------

### Mechanical Attachment

Locking Latch Between Cavity Number	1 + 2, 5 + 6
Mating Retention	With

### Housing Features

Housing Material	PA 6.6
Centerline (Pitch)	5 mm [.197 in]

### Industry Standards

UL Flammability Rating	UL 94V-2
------------------------	----------

### Packaging Features

Packaging Quantity	1000
Packaging Method	Bag & Box

### Product Compliance

[For compliance documentation, visit the product page on TE.com>](#)

EU RoHS Directive 2011/65/EU	Compliant
EU ELV Directive 2000/53/EC	Not Yet Reviewed
China RoHS 2 Directive MIIT Order No 32, 2016	No Restricted Materials Above Threshold
EU REACH Regulation (EC) No. 1907/2006	Current ECHA Candidate List: JUNE 2024 (241) Not Yet Reviewed
Halogen Content	Not Yet Reviewed for halogen content
Solder Process Capability	Not applicable for solder process capability

#### Product Compliance Disclaimer

This information is provided based on reasonable inquiry of our suppliers and represents our current actual knowledge based on the information they provided. This information is subject to change. The part numbers that TE has identified as EU RoHS compliant have a maximum concentration of 0.1% by weight in homogenous materials for lead, hexavalent chromium, mercury, PBB, PBDE, DBP, BBP, DEHP, DIBP, and 0.01% for cadmium, or qualify for an exemption to these limits as defined in the Annexes of Directive 2011/65/EU (RoHS2). Finished electrical and electronic equipment products will be CE marked as required by Directive 2011/65/EU. Components may not be CE marked. Additionally, the part numbers that TE has identified as EU ELV compliant have a maximum concentration of 0.1% by weight in homogenous materials for lead, hexavalent chromium, and mercury, and 0.01% for cadmium, or qualify for an exemption to these limits as defined in the Annexes of Directive 2000/53/EC (ELV). Regarding the REACH Regulations, TE's information on SVHC in articles for this part number is still based on the European Chemical Agency (ECHA) 'Guidance on requirements for substances in articles' (Version: 2, April 2011), applying the 0.1% weight on weight concentration threshold at the finished product level. TE is aware of the European Court of Justice ruling of September 10th, 2015 also known as O5A (Once An Article Always An Article) stating that, in case of 'complex object', the threshold for a SVHC must be applied to both the product as a whole and simultaneously to each of the articles forming part of its composition. TE has evaluated this ruling based on the new ECHA "Guidance on requirements for substances in articles" (June 2017, version 4.0) and will be updating its statements accordingly.

### Also in the Series | RAST 5 IDC Connectors



Automotive Terminals(8)



Connector Contacts(14)

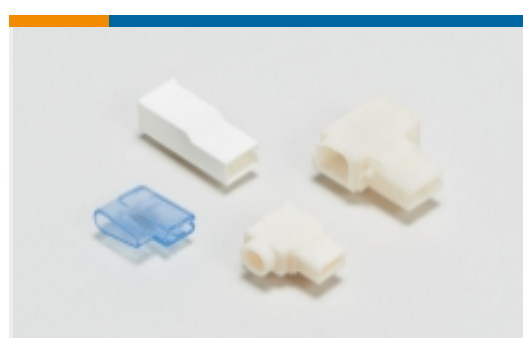

Crimp Terminal Housings(39)



Insertion & Extraction Tools(1)

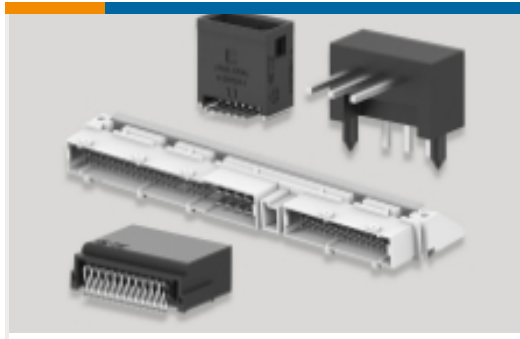

PCB Headers & Receptacles(417)



Rectangular Connector Housings(1)

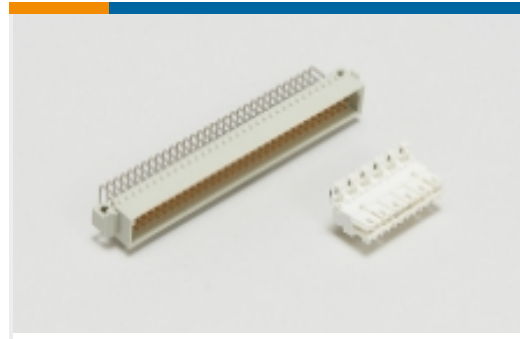

Standard Edge Connectors(32)



Standard Rectangular Connectors(63)



Wire-to-Board Connector Assemblies & Housings(202)

## Also in the Series | RAST 5D



Automotive Terminals(5)



Connector Contacts(10)



Insertion & Extraction Tools(1)

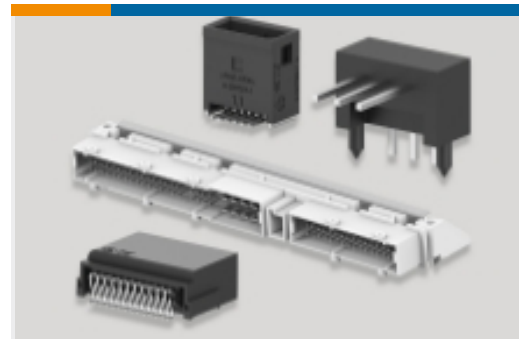

PCB Headers & Receptacles(69)



Wire-to-Board Connector Assemblies & Housings(78)

## Customers Also Bought



TE Part #530219P009  
RNF-150-1/4-0-1.25IN

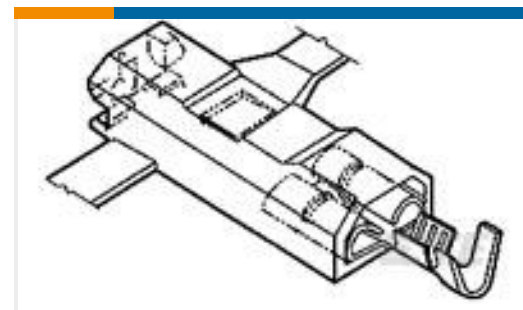

TE Part #521081-1  
ULTRA-POD 250 ASSY REC 18-14  
AWG BR



TE Part #1-521253-3  
PL MKIII & FASTON 250 HSG 2P  
NYLON GREEN

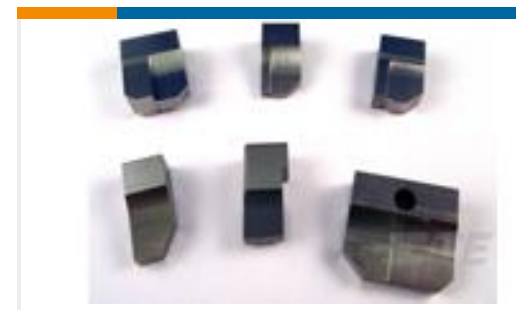

TE Part #1-853088-0  
ANVIL



TE Part #1852646-1  
EFHBPO200TABLOCK.2100 LM/G



TE Part #1855118-1  
U POD .187 STRAIGHT SAPR090F140F  
LM & G

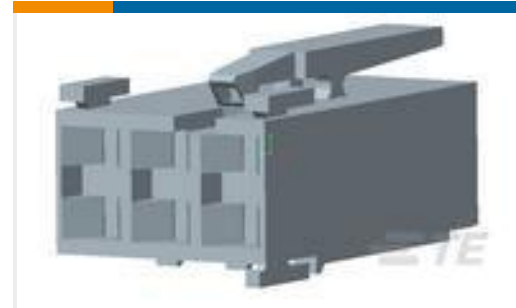

TE Part #2-1241817-3  
STD TIM HOUSING MKII 3POS

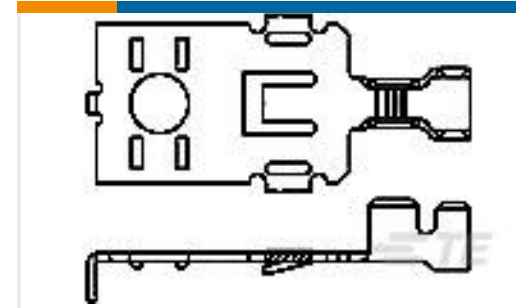

TE Part #63496-1  
POWER RING TERMINAL TAB 16-10  
AWG BR

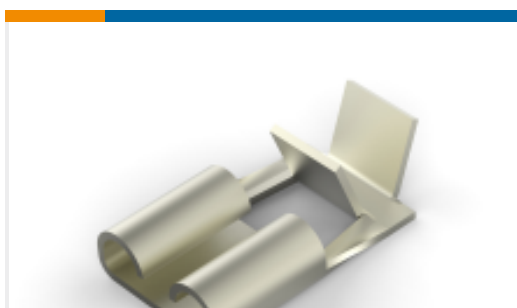

TE Part #1217972-2  
250 FASTON, FLAG, REC., 18-14 AWG,  
NPST

## Documents

### Product Drawings

#### 6POS MT - EDGE HOUSING

English

### CAD Files

#### 3D PDF

3D

#### Customer View Model

[ENG\\_CVM\\_CVM\\_1703111-2\\_B.2d\\_dxf.zip](#)

English

#### Customer View Model

[ENG\\_CVM\\_CVM\\_1703111-2\\_B.3d\\_igs.zip](#)

English

#### Customer View Model

[ENG\\_CVM\\_CVM\\_1703111-2\\_B.3d\\_stp.zip](#)

English

By downloading the CAD file I accept and agree to the [Terms and Conditions](#) of use.

### Datasheets & Catalog Pages



## RAST Connector System Catalog

English